

# Photometric Test Report



## ECLPANELTWCJR

230 W Tunable White and colourful

LED soft panel

## CONTENTS

Table of contents	2
Testing process	4
Color preset Full on	
Filter HD	5
Filter MD	8
Filter LD	11
Filter INT	14
Color preset Red	
Filter HD	17
Filter MD	20
Filter LD	23
Filter INT	26
Color preset Green	
Filter HD	29
Filter MD	32
Filter LD	35
Filter INT	38
Color preset Blue	
Filter HD	41
Filter MD	44
Filter LD	47
Filter INT	50
Color preset White	
Filter HD	53
Filter MD	56
Filter LD	59
Filter INT	62
Color temperature 2800K	
Filter HD	65
Filter MD	70
Filter LD	75
Filter INT	80

**Color temperature 3200K**

Filter HD	85
Filter MD	90
Filter LD	95
Filter INT	100

**Color temperature 4000K**

Filter HD	105
Filter MD	110
Filter LD	115
Filter INT	120

**Color temperature 5600K**

Filter HD	125
Filter MD	130
Filter LD	135
Filter INT	140

**Color temperature 6000K**

Filter HD	145
Filter MD	150
Filter LD	155
Filter INT	160

## TESTING PROCESS

Prolights has its own optical testing laboratory in order to provide accurate photometric reports for its lighting products. The testing laboratory contains certain variety of precise lighting measurement systems that ensure an optimal reading of all the characteristic parameters of the lighting devices. All measurements are made at a controlled room temperature of 20°C without any external light sources. This photometric report is obtained through the data measured by a high precision measurement system and analyzed by a dedicate software.

### **Prolights measurement instrument**

Prolights measurement instrument is a complete measurement system for any light source. It's equipped with two-axis goniometer, that enables to measure the full 3D distribution field of the light source. This instrument measures the light intensity, the beam angle and the most significant colors parameters, like color temperature, spectral distribution, CRI, CQS, TM-30 with a very high accuracy rate.

**Please Note:** All measurements are made with light source at operating temperature. Before starting the measurement, the instrument analyzes the process of the light source during the heating phase. The measuring process of all the parameters begins only when the light emission is stable, that is with a variation of less than 0.5% in a 15 minutes time frame.

### **Prolights measurement software**

The software provides user friendly interface for the operator who does the measurements, and it also analyzes and processes all the collected data by the instrument. With this software it is possible to see the measured data in real-time and it is possible to examine all the measured data and graphics afterwards as well. All information is collected in a specific Prolights template, and the software creates also IES and LDT files, which are widely used to transfer the photometric data, and to develop lighting system.

Additionally, the fixtures are rechecked using various hand-held instruments like Sekonic C-700 and Gossen Mavospec Base, this is done to ensure, that the data in the photometric report are as accurate as possible.



Total lumen output:

13890 lm

Peak candela output:

4791 cd

**PRODUCT NAME:**

ECLPANEL TWCJR

**MEASUREMENT CONDITIONS:**

Beam angle:

Filter HD

Target:

Full On

Operator:

Paolo Carvone

Date and time:

14/05/2020 15:28:05

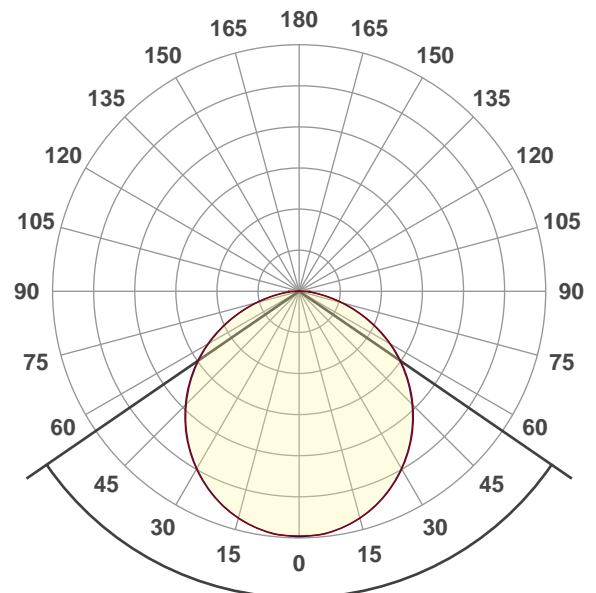

Beam angle 50%: 111°

Field angle 10%: 161,2°

Cut off angle 2.5%: 176,9°

Spectra

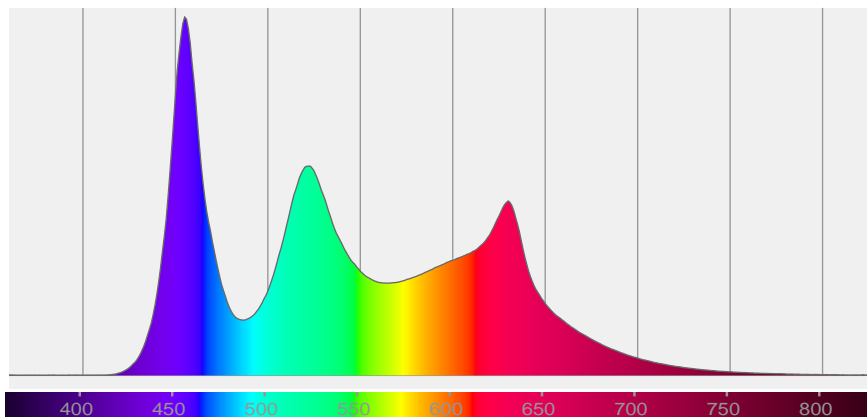

# BEAM DETAILS



Beam angle 50%	Field angle 10%	Cut off angle 2,5%	Intensity ratio in 120° cone	Intensity ratio in 90° cone
111°	161,2°	176,9°	76,5%	52,3%

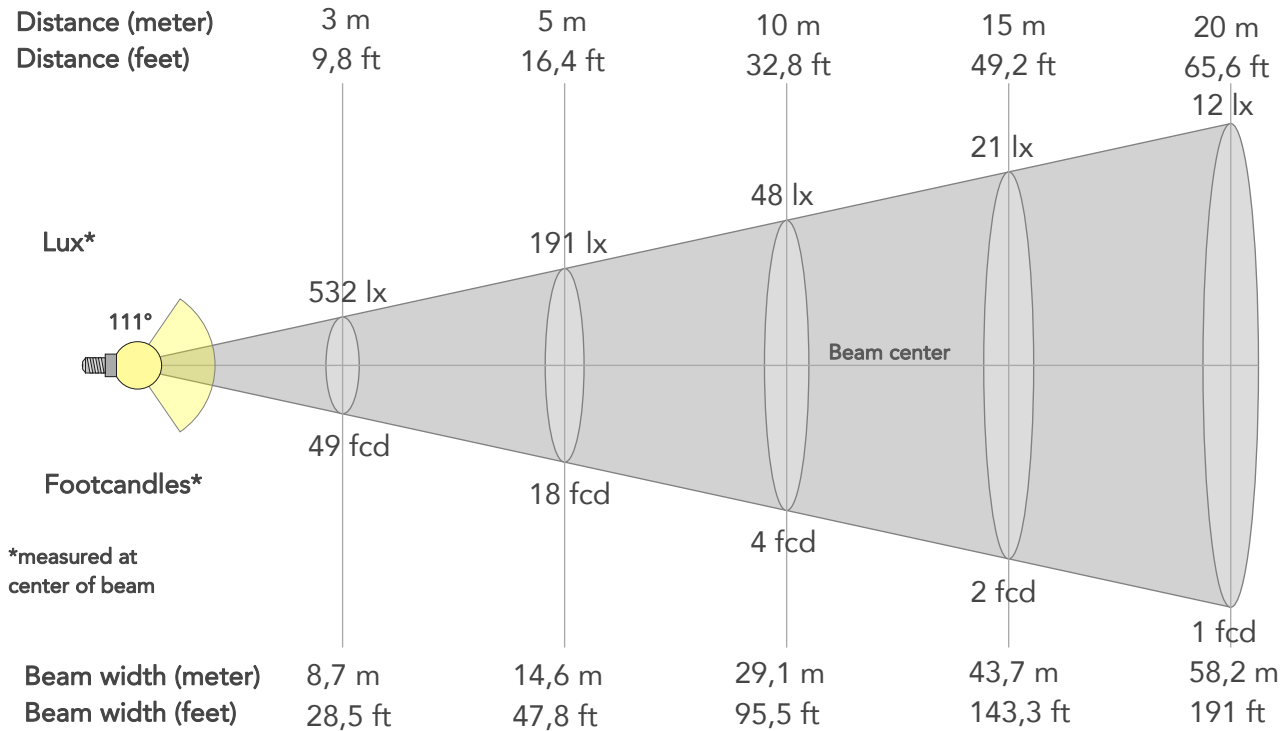

## BEAM INTENSITIES AND WIDTHS

Distance	1m	2m	3m	4m	5m	7,5m	10m	15m	20m	25m	30m	40m	50m
Distance	3,3ft	6,6ft	9,8ft	13,1ft	16,4ft	24,6ft	32,8ft	49,2ft	65,6ft	82ft	98,4ft	131,2ft	164ft
Lux	4786lx	1197lx	532lx	299lx	191lx	85lx	48lx	21lx	12lx	8lx	5lx	3lx	2lx
Footcand.	445fcd	111fcd	49fcd	28fcd	18fcd	8fcd	4fcd	2fcd	1fcd	1fcd	0fcd	0fcd	0fcd
Beam wid.	2,9m	5,8m	8,7m	11,6m	14,6m	21,8m	29,1m	43,7m	58,2m	72,8m	87,4m	116,5m	145,6m
Beam wid.	9,6ft	19,2ft	28,5ft	38,1ft	47,8ft	71,6ft	95,5ft	143,3ft	191ft	238,8ft	286,5ft	382ft	477,5ft

## LINEAR DISTRIBUTION DIAGRAM

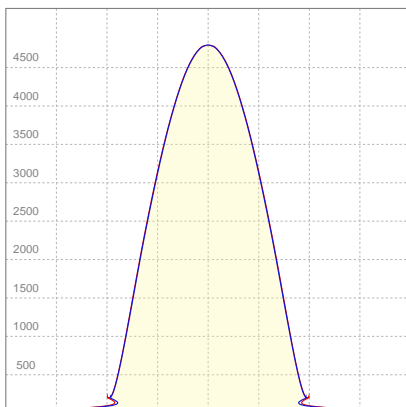

## ELECTRICAL SPECIFICATIONS

Input voltage	Input current	Input power	Effeciency
224V	1,03A	227,9W	61lm/W
<b>Power Fc</b>			
<b>0,98</b>			

## ISO CANDELA DIAGRAM

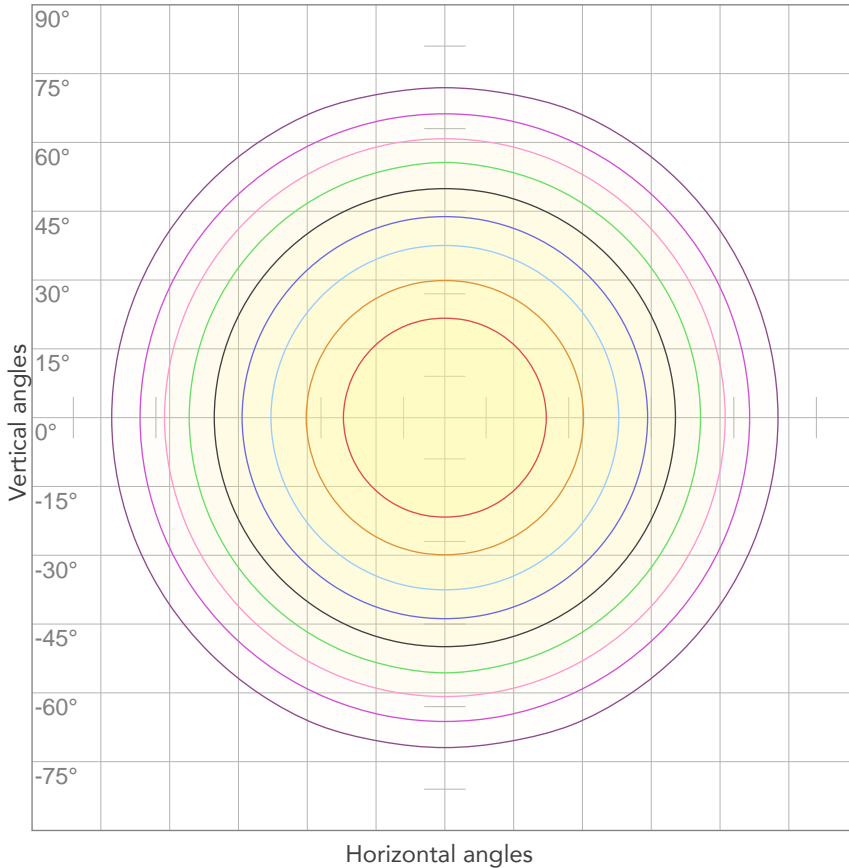

10%	479 cd
20%	957 cd
30%	1436 cd
40%	1914 cd
50%	2393 cd
60%	2872 cd
70%	3350 cd
80%	3829 cd

Conditions:

Number of c-planes: 4

Candela at center: 4786 cd

## ISO LUX DIAGRAM

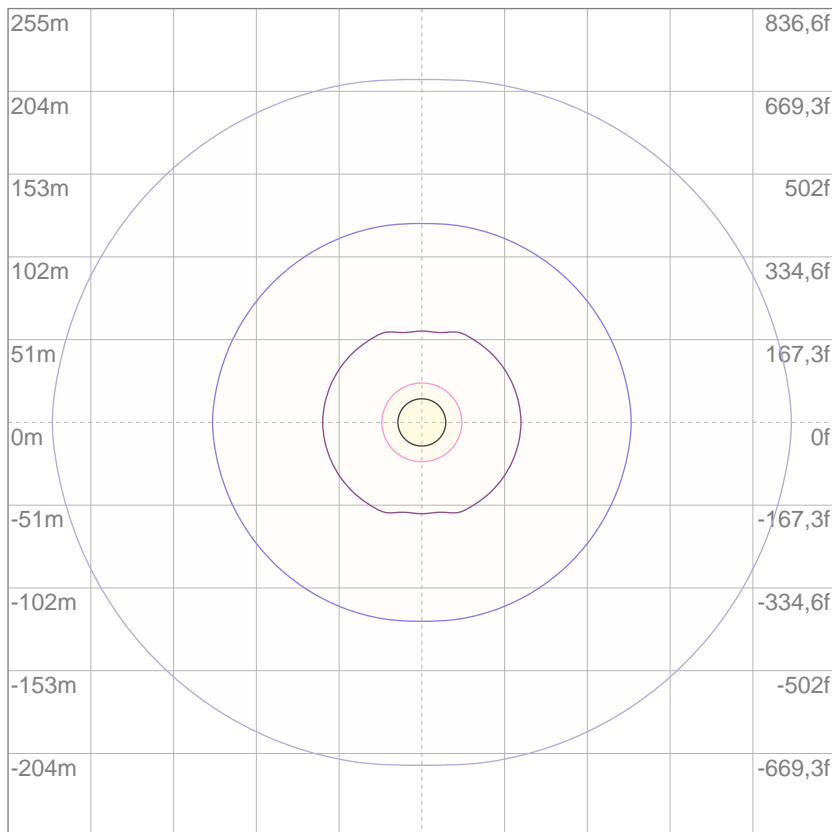

3%	1,44 lx
5%	2,39 lx
10%	4,79 lx
30%	14,4 lx
50%	23,9 lx

Conditions:

Number of c-planes: 4

Lux at center: 47,9 lx

*Lux distribution on a surface when lamp is mounted at 10 meters from the surface.*

Mounting height: 10 meters (33 feet)



Total lumen output:

16494 lm

Peak candela output:

6257 cd

**PRODUCT NAME:**

ECLPANEL TWCJR

**MEASUREMENT CONDITIONS:**

Beam angle:

Filter MD

Target:

Full On

Operator:

Paolo Carvone

Date and time:

14/05/2020 15:15:04

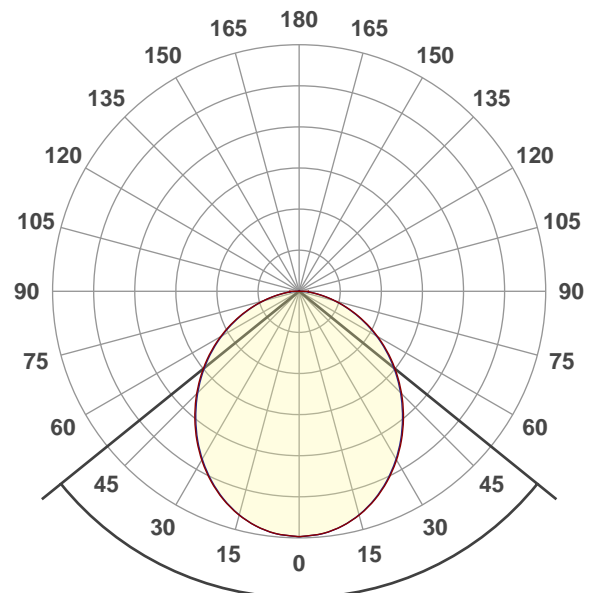

Beam angle 50%: 102,1°

Field angle 10%: 158,3°

Cut off angle 2.5%: 176,8°

Spectra

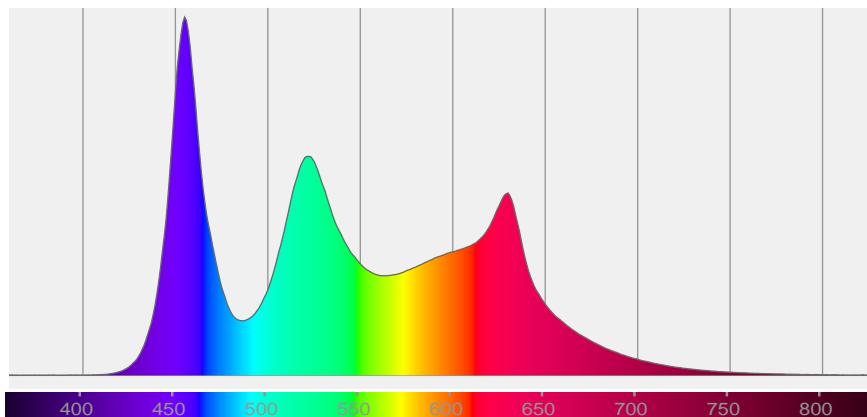



# BEAM DETAILS



Beam angle 50%	Field angle 10%	Cut off angle 2,5%	Intensity ratio in 120° cone	Intensity ratio in 90° cone
102,1°	158,3°	176,8°	78,0%	54,5%

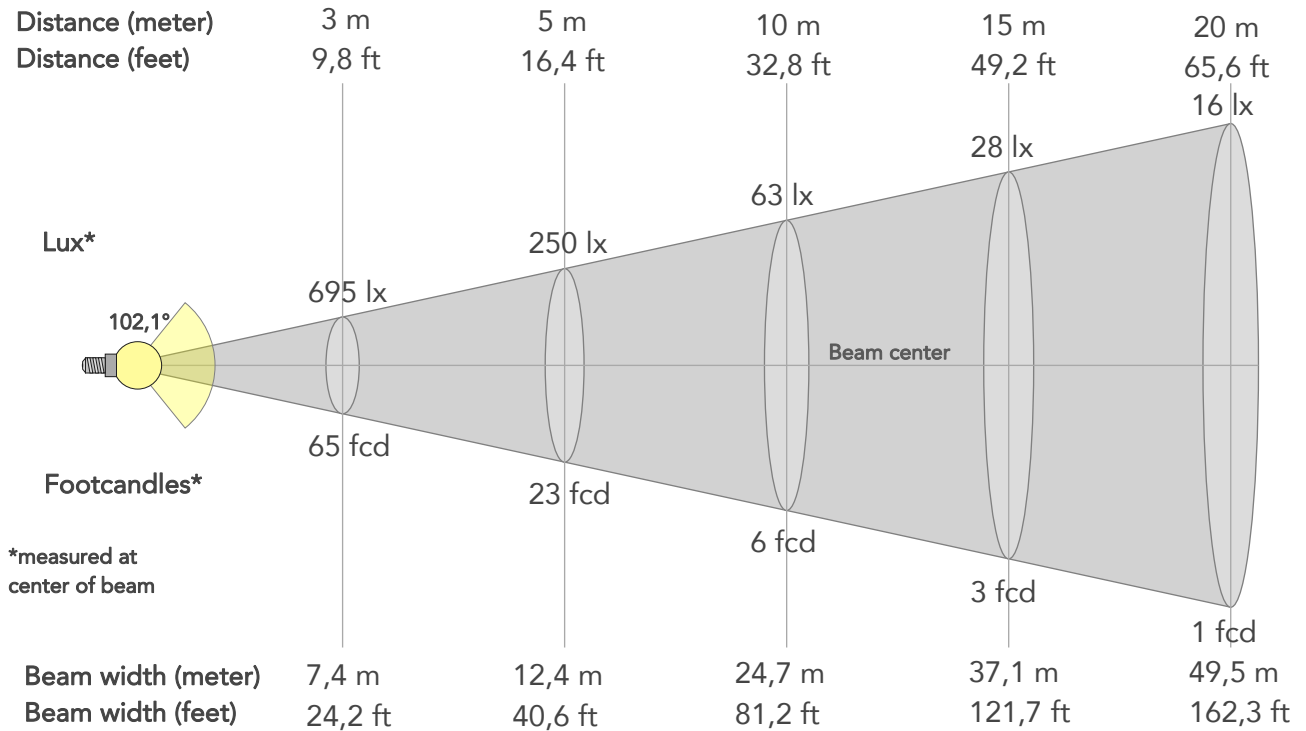

## BEAM INTENSITIES AND WIDTHS

Distance	1m	2m	3m	4m	5m	7,5m	10m	15m	20m	25m	30m	40m	50m
Distance	3,3ft	6,6ft	9,8ft	13,1ft	16,4ft	24,6ft	32,8ft	49,2ft	65,6ft	82ft	98,4ft	131,2ft	164ft
Lux	6256lx	1564lx	695lx	391lx	250lx	111lx	63lx	28lx	16lx	10lx	7lx	4lx	3lx
Footcand.	581fcd	145fcd	65fcd	36fcd	23fcd	10fcd	6fcd	3fcd	1fcd	1fcd	1fcd	0fcd	0fcd
Beam wid.	2,5m	4,9m	7,4m	9,9m	12,4m	18,6m	24,7m	37,1m	49,5m	61,9m	74,2m	99m	123,7m
Beam wid.	8,2ft	16,3ft	24,2ft	32,4ft	40,6ft	60,9ft	81,2ft	121,7ft	162,3ft	202,9ft	243,5ft	324,6ft	405,8ft

## LINEAR DISTRIBUTION DIAGRAM

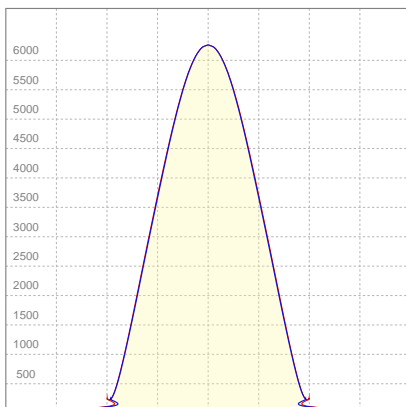

## ELECTRICAL SPECIFICATIONS

Input voltage	Input current	Input power	Effeciency
225V	1,03A	227,8W	72lm/W

Power Fc
0,98

## ISO CANDELA DIAGRAM

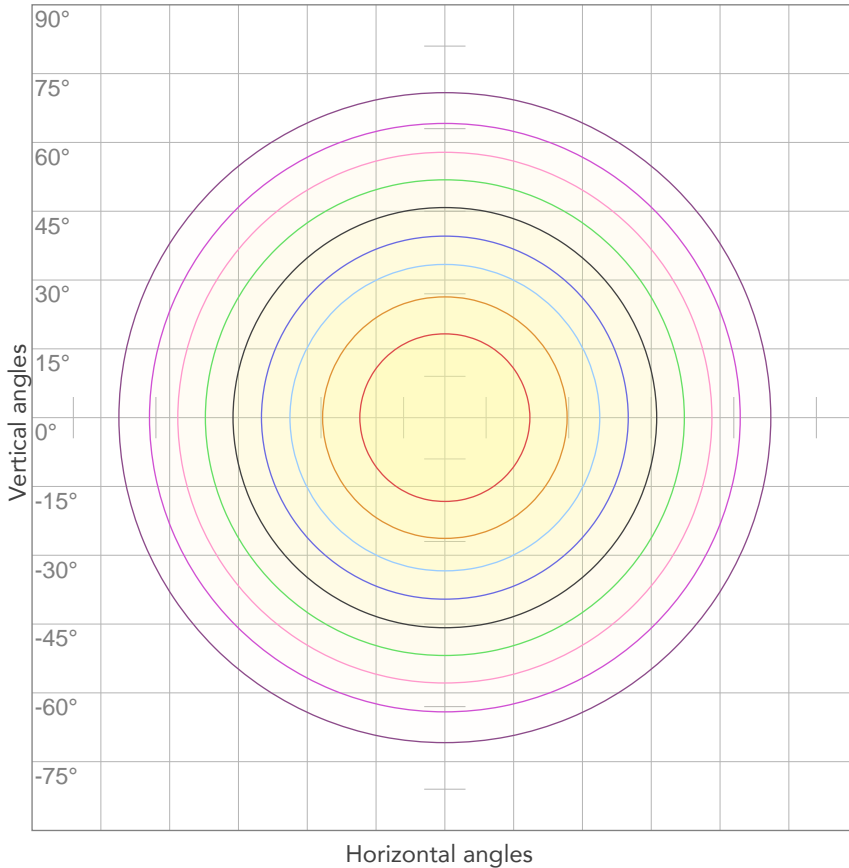

10%	626 cd
20%	1251 cd
30%	1877 cd
40%	2502 cd
50%	3128 cd
60%	3754 cd
70%	4379 cd
80%	5005 cd

**Conditions:**

Number of c-planes: 4

Candela at center: 6256 cd

## ISO LUX DIAGRAM

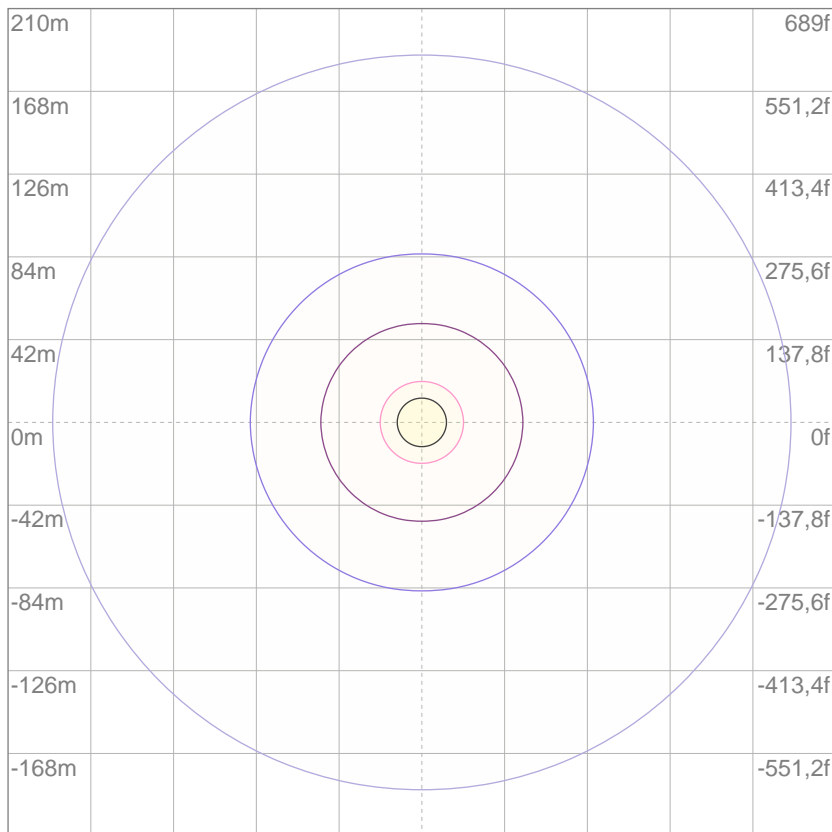

3%	1,88 lx
5%	3,13 lx
10%	6,26 lx
30%	18,8 lx
50%	31,3 lx

**Conditions:**

Number of c-planes: 4

Lux at center: 62,6 lx

*Lux distribution on a surface when lamp is mounted at 10 meters from the surface.*

Mounting height: 10 meters (33 feet)



Total lumen output:

16566 lm

Peak candela output:

6310 cd

**PRODUCT NAME:**

ECLPANEL TWCJR

**MEASUREMENT CONDITIONS:**

Beam angle:

Filter LD

Target:

Full On

Operator:

Paolo Carvone

Date and time:

14/05/2020 15:25:53

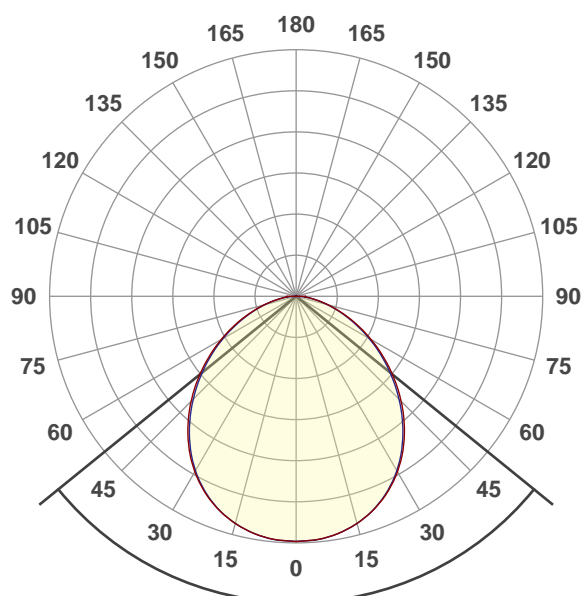

Beam angle 50%: 101,9°

Field angle 10%: 156°

Cut off angle 2.5%: 176,3°

Spectra

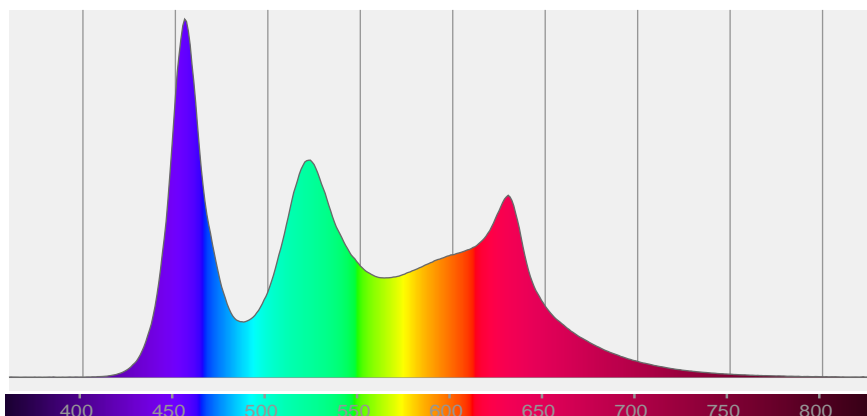

# BEAM DETAILS



Beam angle 50%	Field angle 10%	Cut off angle 2,5%	Intensity ratio in 120° cone	Intensity ratio in 90° cone
101,9°	156°	176,3°	79,7%	56,4%

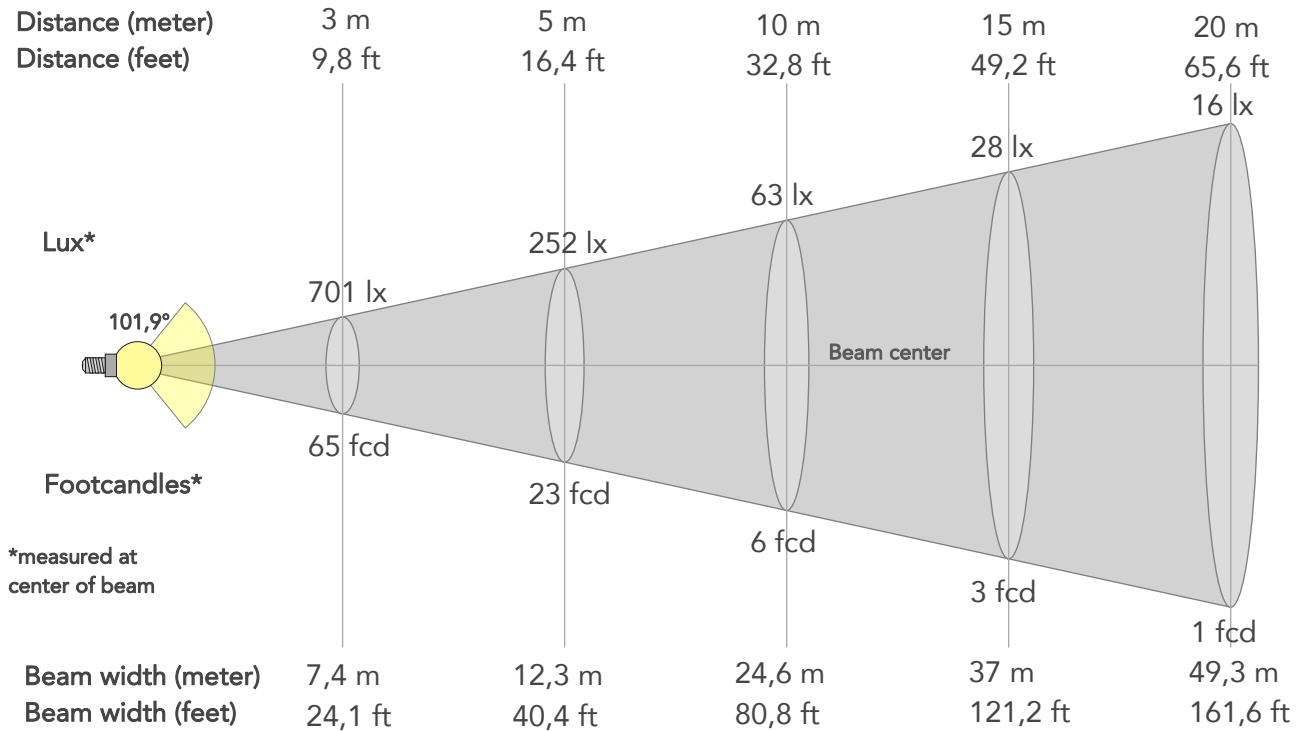

## BEAM INTENSITIES AND WIDTHS

Distance	1m	2m	3m	4m	5m	7,5m	10m	15m	20m	25m	30m	40m	50m
Distance	3,3ft	6,6ft	9,8ft	13,1ft	16,4ft	24,6ft	32,8ft	49,2ft	65,6ft	82ft	98,4ft	131,2ft	164ft
Lux	6308lx	1577lx	701lx	394lx	252lx	112lx	63lx	28lx	16lx	10lx	7lx	4lx	3lx
Footcand.	586fcd	147fcd	65fcd	37fcd	23fcd	10fcd	6fcd	3fcd	1fcd	1fcd	1fcd	0fcd	0fcd
Beam wid.	2,5m	4,9m	7,4m	9,9m	12,3m	18,5m	24,6m	37m	49,3m	61,6m	73,9m	98,6m	123,2m
Beam wid.	8,1ft	16,3ft	24,1ft	32,3ft	40,4ft	60,6ft	80,8ft	121,2ft	161,6ft	202,1ft	242,5ft	323,3ft	404,1ft

## LINEAR DISTRIBUTION DIAGRAM

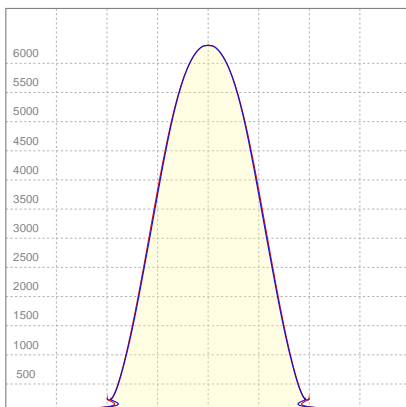

## ELECTRICAL SPECIFICATIONS

Input voltage	Input current	Input power	Effeciency
225V	1,03A	227,8W	73lm/W

Power Fc
0,98

## ISO CANDELA DIAGRAM

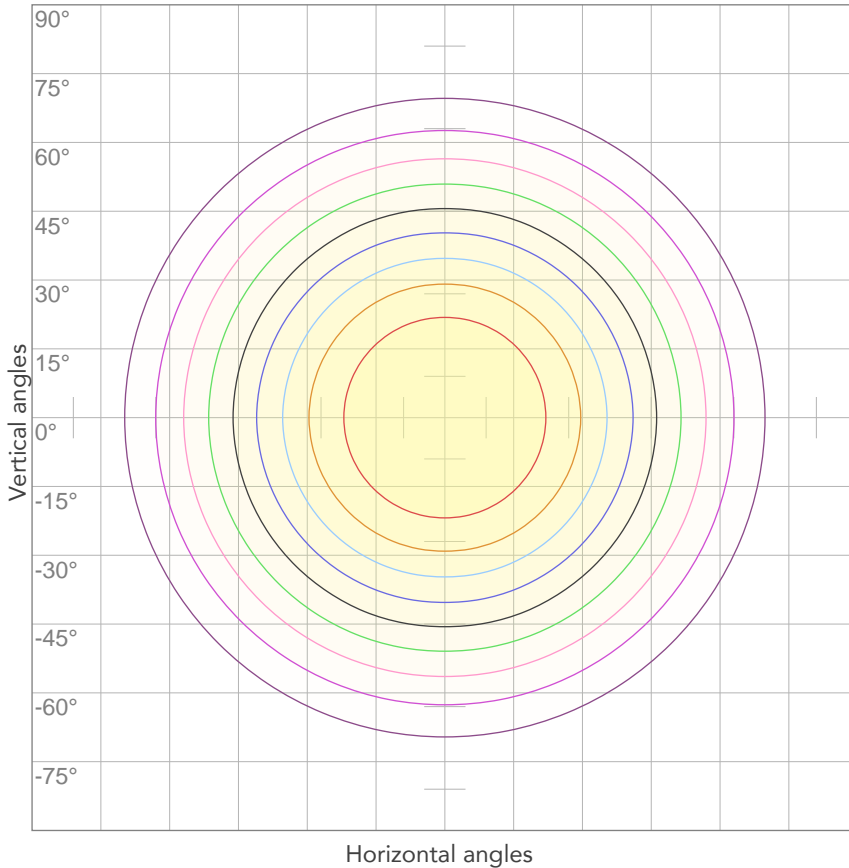

10%	631 cd
20%	1262 cd
30%	1893 cd
40%	2523 cd
50%	3154 cd
60%	3785 cd
70%	4416 cd
80%	5047 cd

**Conditions:**

Number of c-planes: 4

Candela at center: 6308 cd

## ISO LUX DIAGRAM

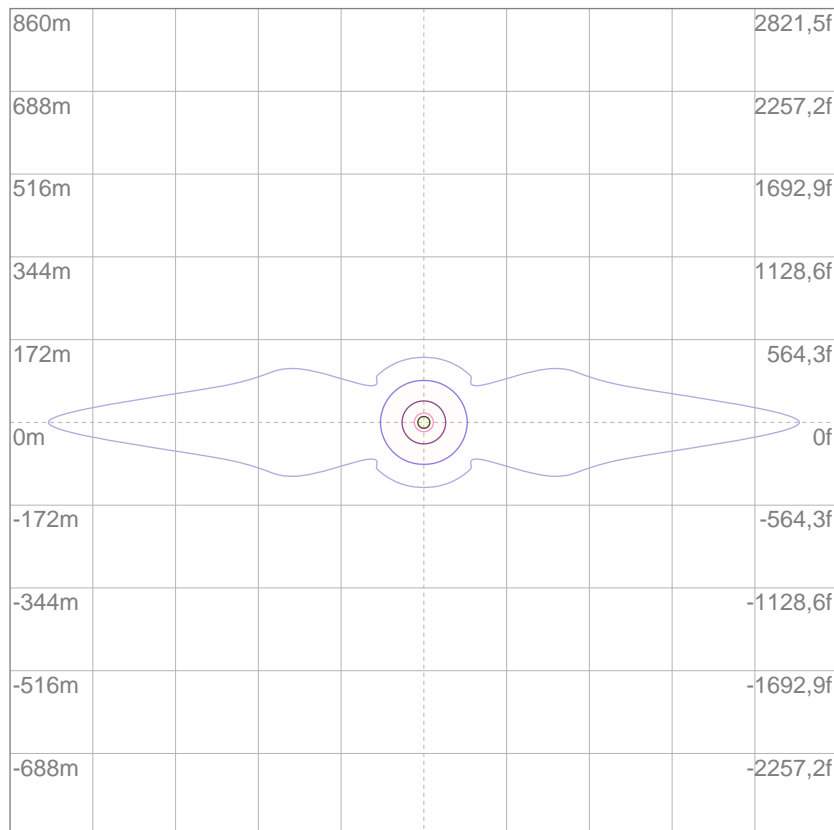

3%	1,89 lx
5%	3,15 lx
10%	6,31 lx
30%	18,9 lx
50%	31,5 lx

**Conditions:**

Number of c-planes: 4

Lux at center: 63,1 lx

*Lux distribution on a surface when lamp is mounted at 10 meters from the surface.*

Mounting height: 10 meters (33 feet)



Total lumen output:

11507 lm

Peak candela output:

7554 cd

**PRODUCT NAME:**

ECLPANEL TWCJR

**MEASUREMENT CONDITIONS:**

Beam angle:

Filter INT

Target:

Full On HB

Operator:

Paolo Carvone

Date and time:

13/11/2020 11:48:36

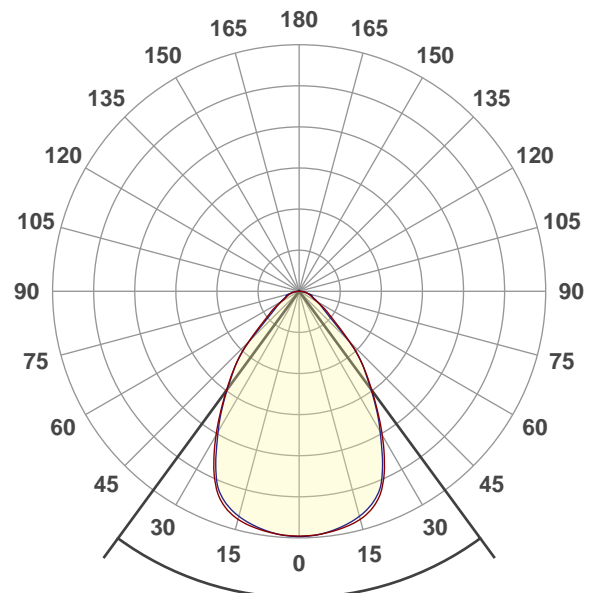

Beam angle 50%: 72,5°

Field angle 10%: 115,6°

Cut off angle 2.5%: 161,1°

Spectra

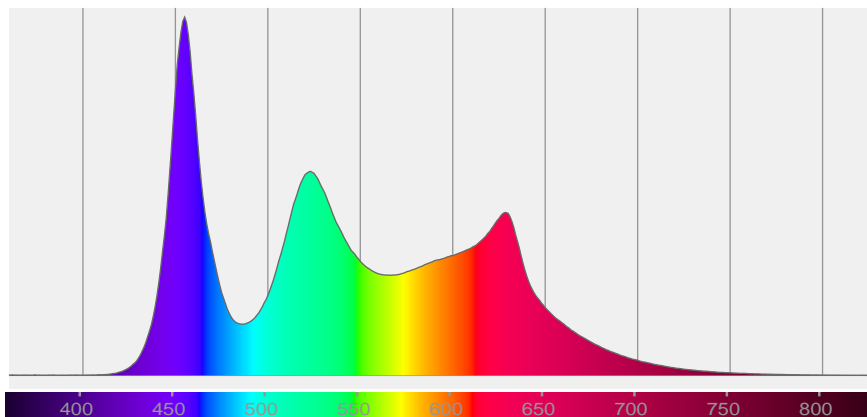

# BEAM DETAILS



Beam angle 50%	Field angle 10%	Cut off angle 2,5%	Intensity ratio in 120° cone	Intensity ratio in 90° cone
72,5°	115,6°	161,1°	91,8%	78,6%

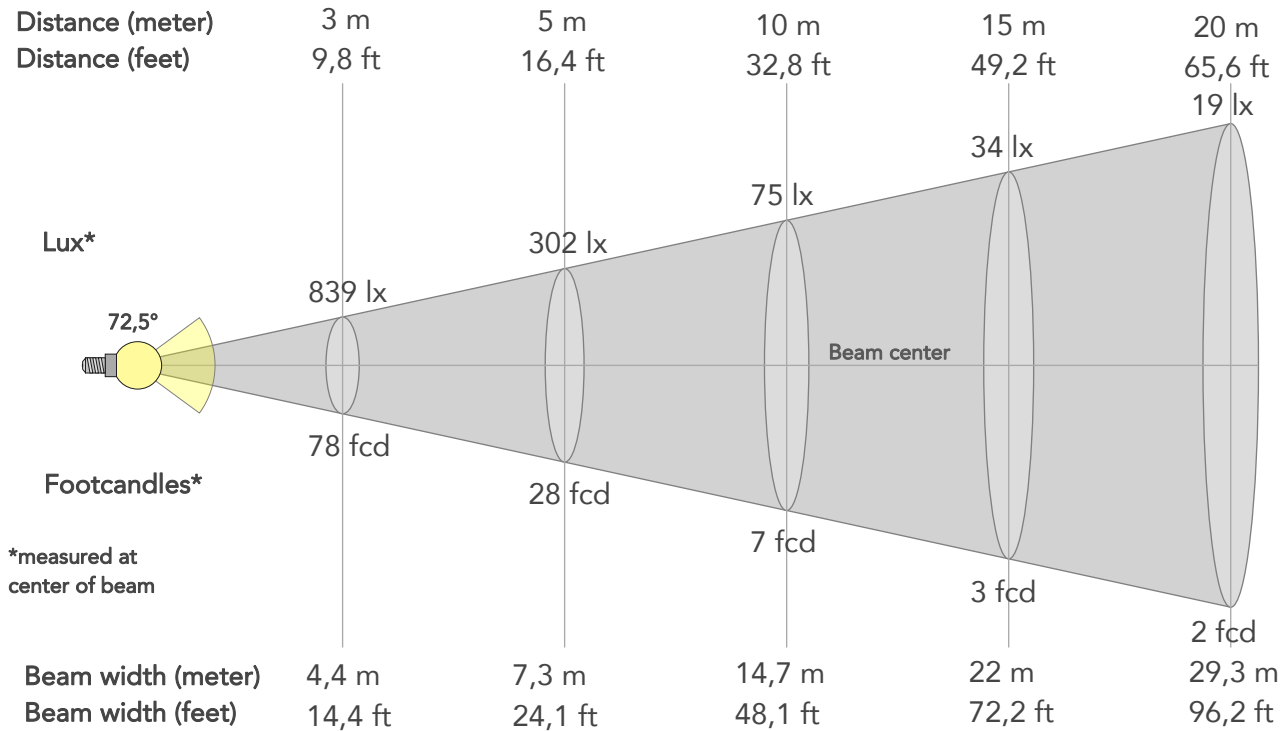

## BEAM INTENSITIES AND WIDTHS

Distance	1m	2m	3m	4m	5m	7,5m	10m	15m	20m	25m	30m	40m	50m
Distance	3,3ft	6,6ft	9,8ft	13,1ft	16,4ft	24,6ft	32,8ft	49,2ft	65,6ft	82ft	98,4ft	131,2ft	164ft
Lux	7549lx	1887lx	839lx	472lx	302lx	134lx	75lx	34lx	19lx	12lx	8lx	5lx	3lx
Footcand.	701fcd	175fcd	78fcd	44fcd	28fcd	12fcd	7fcd	3fcd	2fcd	1fcd	1fcd	0fcd	0fcd
Beam wid.	1,5m	2,9m	4,4m	5,9m	7,3m	11m	14,7m	22m	29,3m	36,7m	44m	58,7m	73,3m
Beam wid.	4,8ft	9,7ft	14,4ft	19,2ft	24,1ft	36,1ft	48,1ft	72,2ft	96,2ft	120,3ft	144,3ft	192,4ft	240,5ft

## LINEAR DISTRIBUTION DIAGRAM

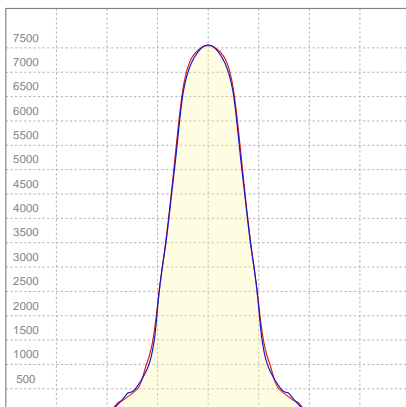

## ELECTRICAL SPECIFICATIONS

Input voltage	Input current	Input power	Effeciency
225V	0,888A	189W	61lm/W

Power FC
0,94

## ISO CANDELA DIAGRAM

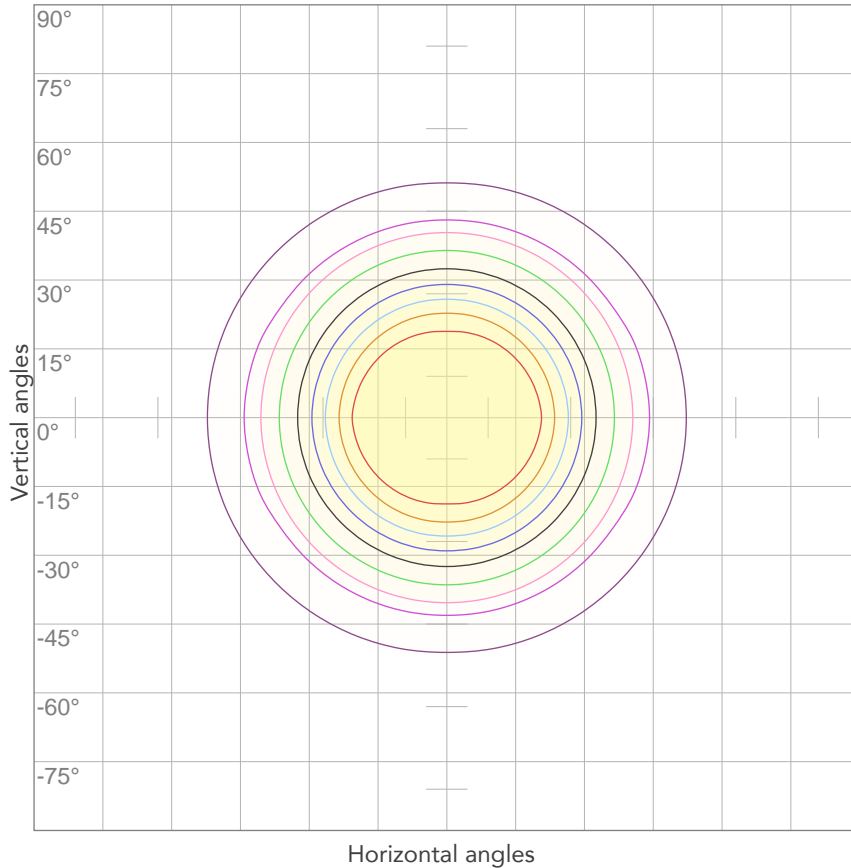

10%	755 cd
20%	1510 cd
30%	2265 cd
40%	3020 cd
50%	3775 cd
60%	4530 cd
70%	5285 cd
80%	6040 cd

Conditions:

Number of c-planes: 4

Candela at center: 7549 cd

## ISO LUX DIAGRAM

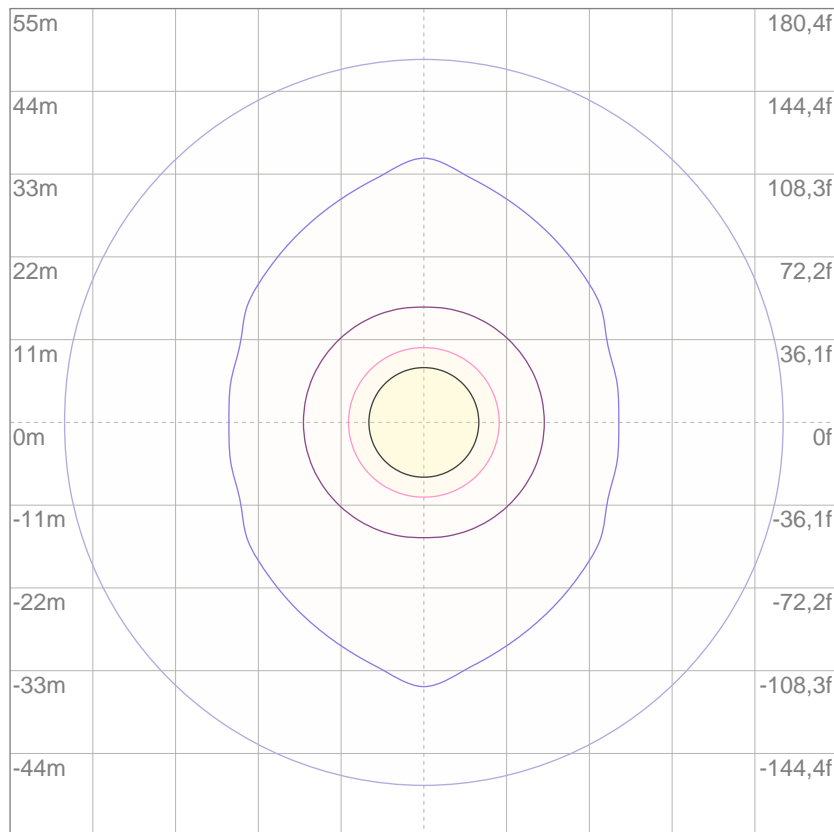

3%	2,26 lx
5%	3,77 lx
10%	7,55 lx
30%	22,6 lx
50%	37,7 lx

Conditions:

Number of c-planes: 4

Lux at center: 75,5 lx

*Lux distribution on a surface when lamp is mounted at 10 meters from the surface.*

Mounting height: 10 meters (33 feet)





Total lumen output:

2421 lm

Peak candela output:

838 cd

**PRODUCT NAME:**

ECLPANEL TWCJR

**MEASUREMENT CONDITIONS:**

Beam angle:

Filter HD

Target:

Red

Operator:

Paolo Carvone

Date and time:

14/05/2020 15:33:40

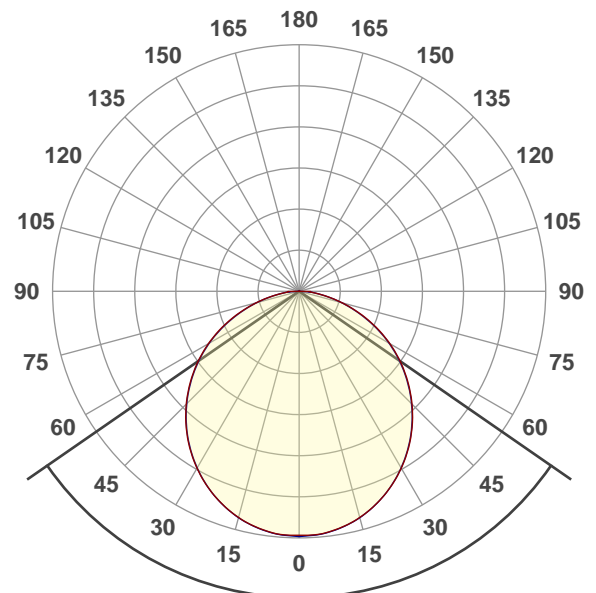

Beam angle 50%: 110,6°

Field angle 10%: 161,2°

Cut off angle 2.5%: 175,3°

Spectra

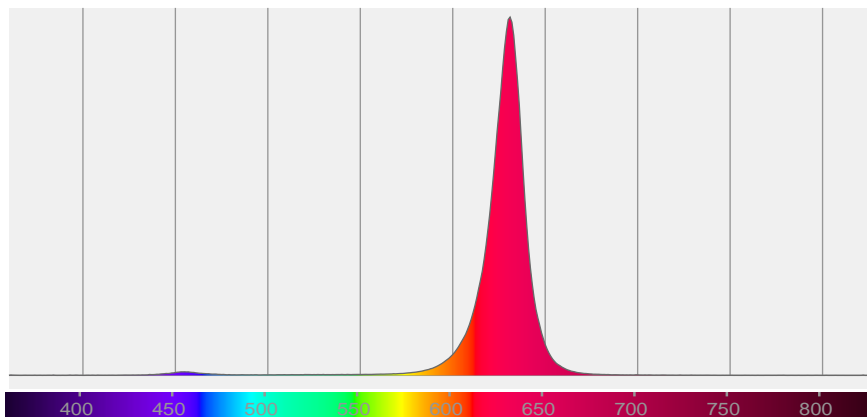

# BEAM DETAILS



Beam angle 50%	Field angle 10%	Cut off angle 2,5%	Intensity ratio in 120° cone	Intensity ratio in 90° cone
110,6°	161,2°	175,3°	76,3%	52,2%

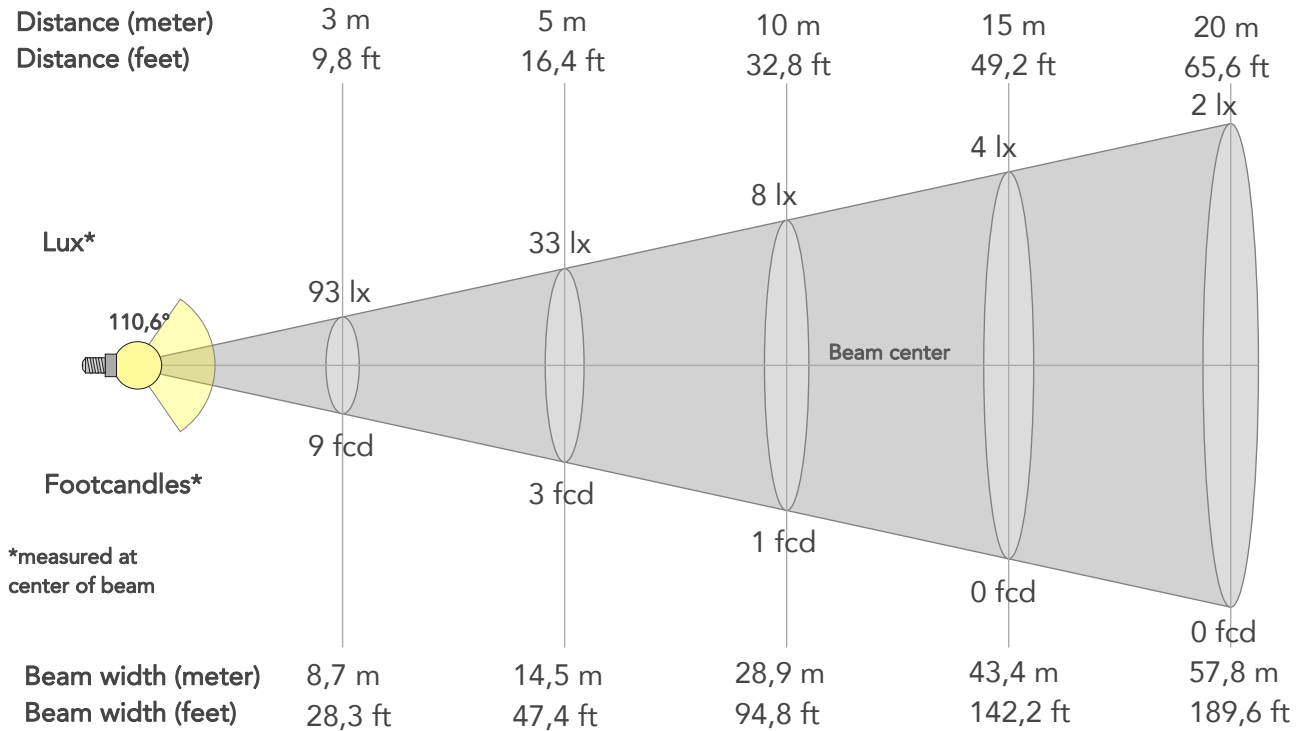

## BEAM INTENSITIES AND WIDTHS

Distance	1m	2m	3m	4m	5m	7,5m	10m	15m	20m	25m	30m	40m	50m
Distance	3,3ft	6,6ft	9,8ft	13,1ft	16,4ft	24,6ft	32,8ft	49,2ft	65,6ft	82ft	98,4ft	131,2ft	164ft
Lux	836lx	209lx	93lx	52lx	33lx	15lx	8lx	4lx	2lx	1lx	1lx	1lx	0lx
Footcand.	78fcd	19fcd	9fcd	5fcd	3fcd	1fcd	1fcd	0fcd	0fcd	0fcd	0fcd	0fcd	0fcd
Beam wid.	2,9m	5,8m	8,7m	11,6m	14,5m	21,7m	28,9m	43,4m	57,8m	72,3m	86,7m	115,6m	144,5m
Beam wid.	9,5ft	19,1ft	28,3ft	37,9ft	47,4ft	71,1ft	94,8ft	142,2ft	189,6ft	237ft	284,4ft	379,2ft	474ft

## LINEAR DISTRIBUTION DIAGRAM

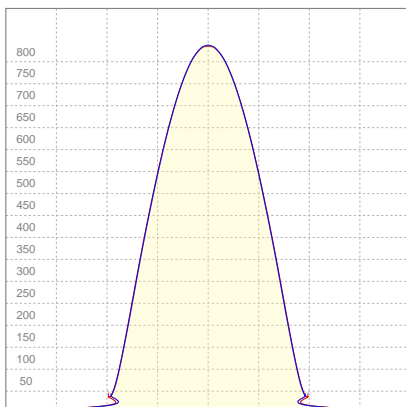

## ELECTRICAL SPECIFICATIONS

Input voltage	Input current	Input power	Effeciency
226V	0,392A	78,6W	31lm/W

## ISO CANDELA DIAGRAM

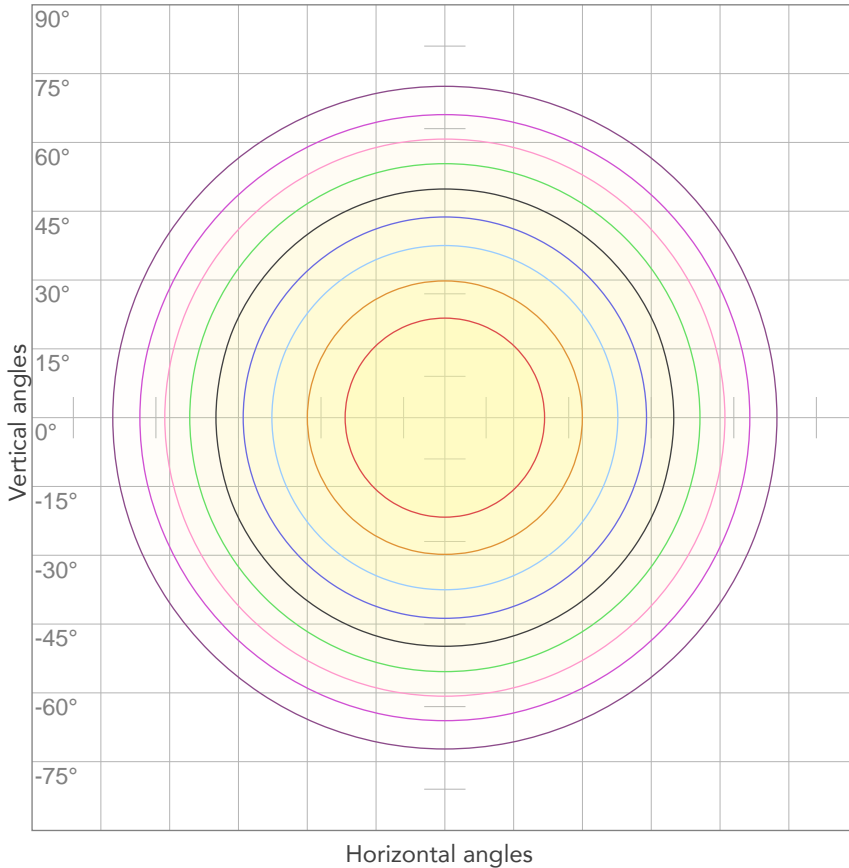

10%	84 cd
20%	167 cd
30%	251 cd
40%	334 cd
50%	418 cd
60%	501 cd
70%	585 cd
80%	669 cd

Conditions:

Number of c-planes: 4

Candela at center: 836 cd

## ISO LUX DIAGRAM

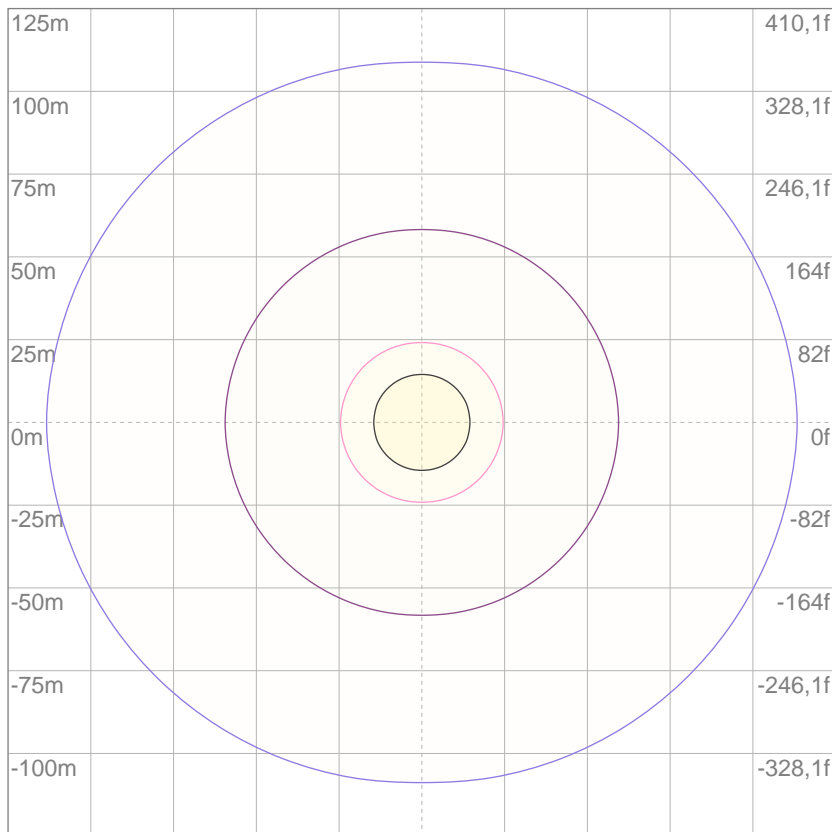

3%	0,251 lx
5%	0,418 lx
10%	0,836 lx
30%	2,51 lx
50%	4,18 lx

Conditions:

Number of c-planes: 4

Lux at center: 8,36 lx

*Lux distribution on a surface when lamp is mounted at 10 meters from the surface.*

Mounting height: 10 meters (33 feet)



Total lumen output:

2832 lm

Peak candela output:

1080 cd

**PRODUCT NAME:**

ECLPANEL TWCJR

**MEASUREMENT CONDITIONS:**

Beam angle:

Filter MD

Target:

Red

Operator:

Paolo Carvone

Date and time:

14/05/2020 15:36:08

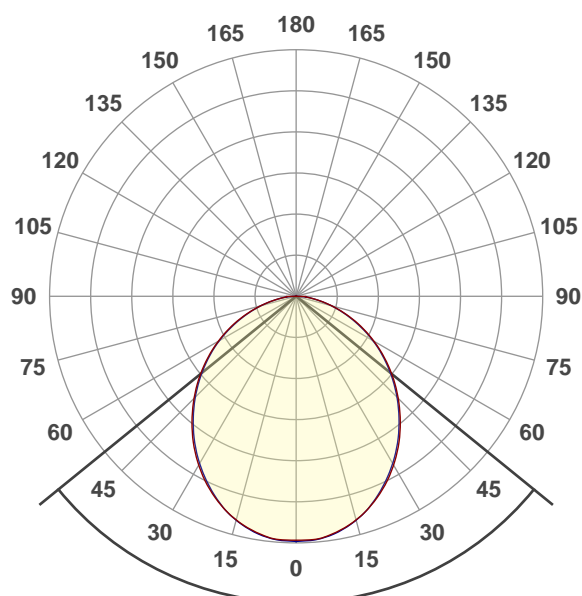

Beam angle 50%: 101,8°

Field angle 10%: 158,1°

Cut off angle 2.5%: 175,1°

Spectra

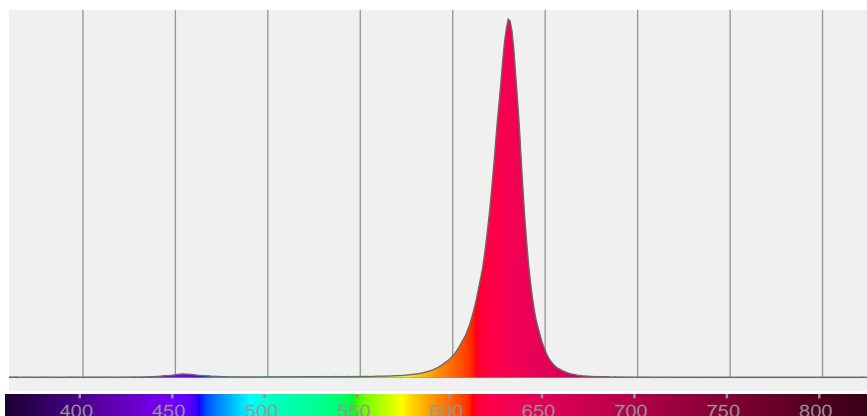

# BEAM DETAILS



Beam angle 50%	Field angle 10%	Cut off angle 2,5%	Intensity ratio in 120° cone	Intensity ratio in 90° cone
101,8°	158,1°	175,1°	78,2%	54,7%

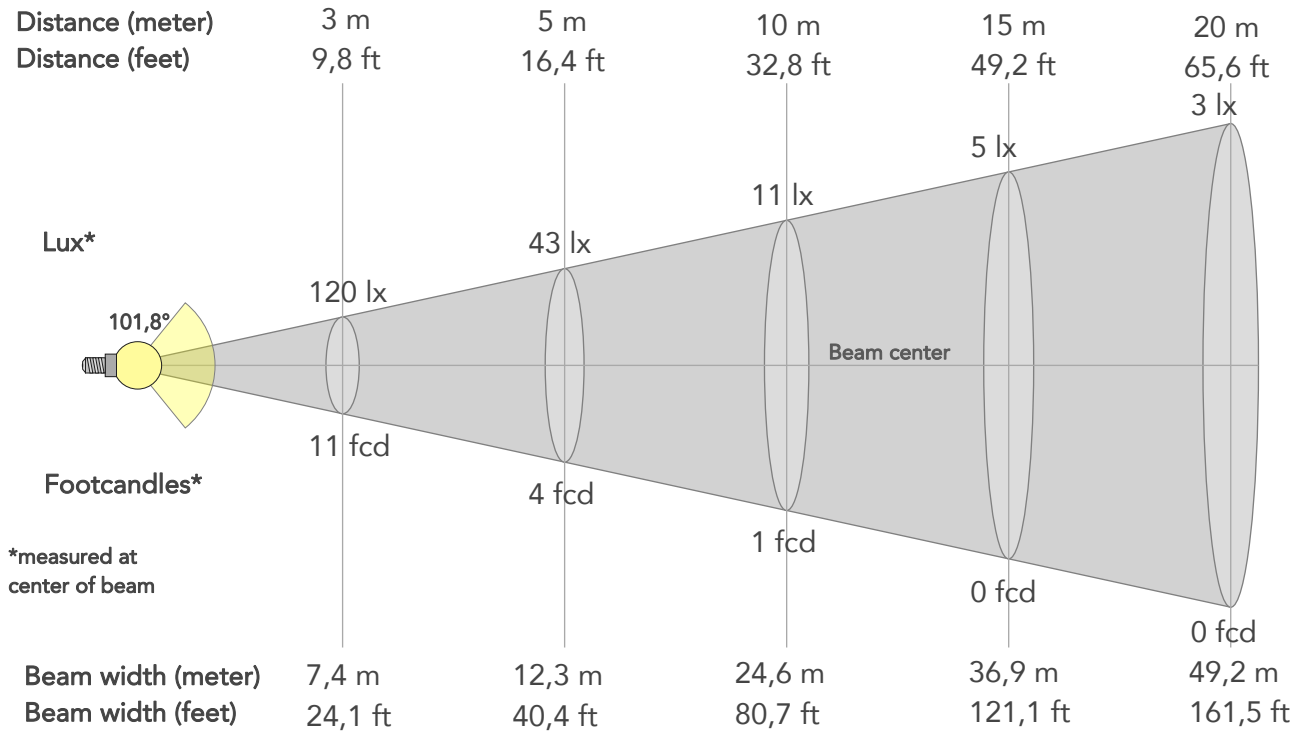

## BEAM INTENSITIES AND WIDTHS

Distance	1m	2m	3m	4m	5m	7,5m	10m	15m	20m	25m	30m	40m	50m
Distance	3,3ft	6,6ft	9,8ft	13,1ft	16,4ft	24,6ft	32,8ft	49,2ft	65,6ft	82ft	98,4ft	131,2ft	164ft
Lux	1077lx	269lx	120lx	67lx	43lx	19lx	11lx	5lx	3lx	2lx	1lx	1lx	0lx
Footcand.	100fcd	25fcd	11fcd	6fcd	4fcd	2fcd	1fcd	0fcd	0fcd	0fcd	0fcd	0fcd	0fcd
Beam wid.	2,5m	4,9m	7,4m	9,8m	12,3m	18,5m	24,6m	36,9m	49,2m	61,5m	73,9m	98,5m	123,1m
Beam wid.	8,1ft	16,2ft	24,1ft	32,2ft	40,4ft	60,6ft	80,7ft	121,1ft	161,5ft	201,9ft	242,2ft	323ft	403,7ft

## LINEAR DISTRIBUTION DIAGRAM

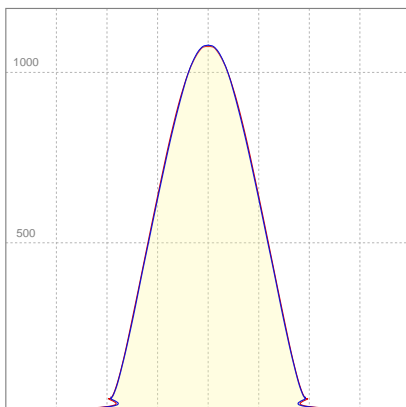

## ELECTRICAL SPECIFICATIONS

Input voltage	Input current	Input power	Effeciency
226V	0,388A	77,3W	37lm/W

## ISO CANDELA DIAGRAM

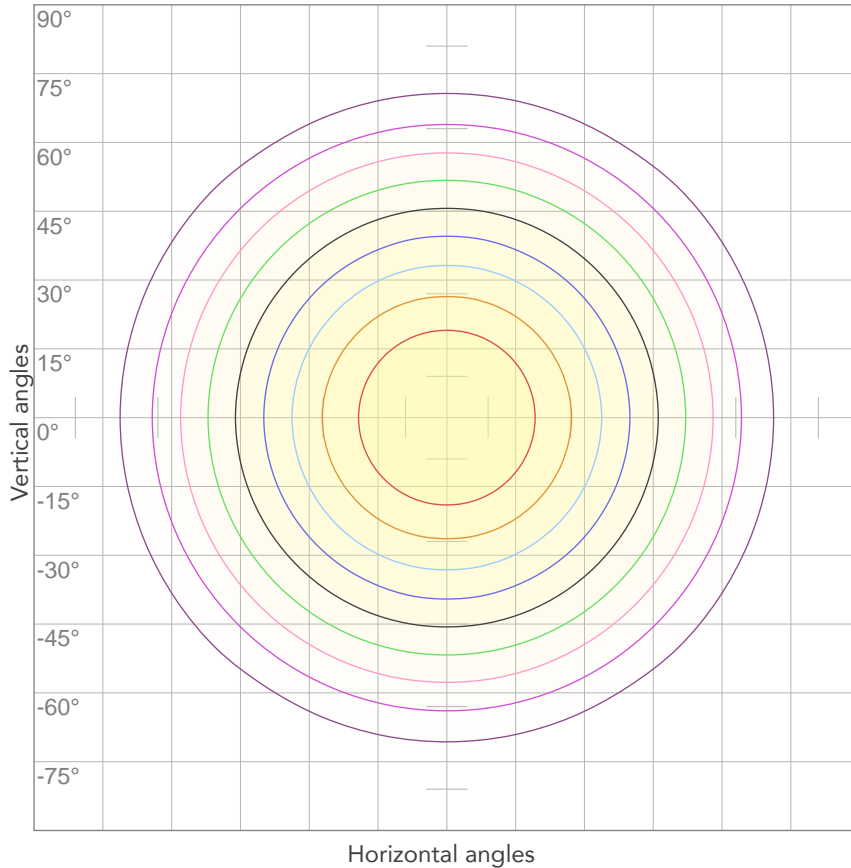

10%	108 cd
20%	215 cd
30%	323 cd
40%	431 cd
50%	539 cd
60%	646 cd
70%	754 cd
80%	862 cd

**Conditions:**

Number of c-planes: 4

Candela at center: 1077 cd

## ISO LUX DIAGRAM

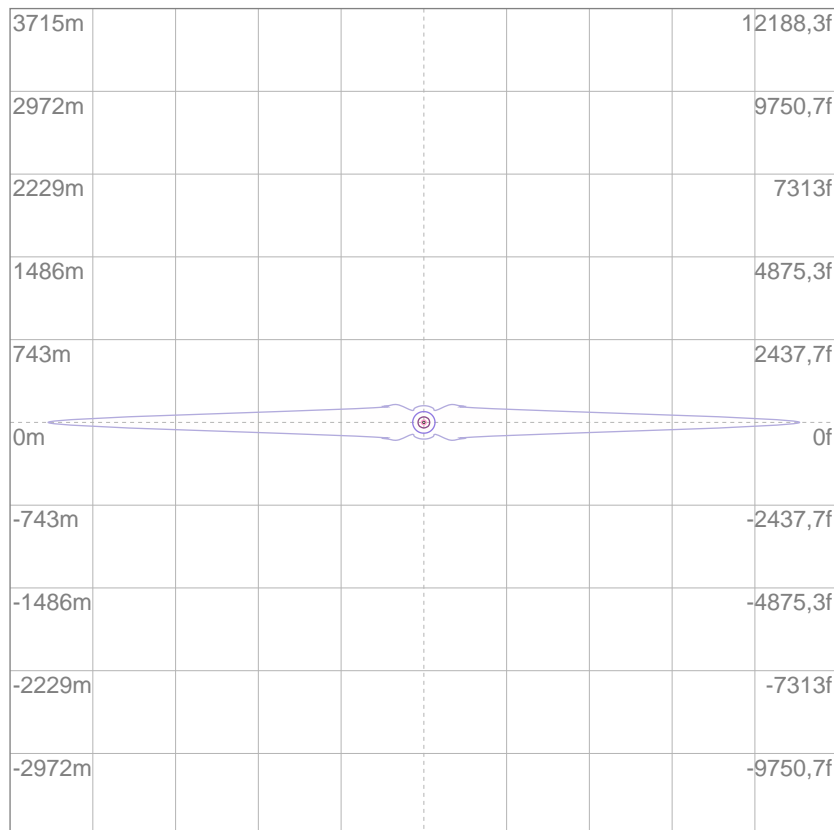

3%	0,323 lx
5%	0,539 lx
10%	1,08 lx
30%	3,23 lx
50%	5,39 lx

**Conditions:**

Number of c-planes: 4

Lux at center: 10,8 lx

*Lux distribution on a surface when lamp is mounted at 10 meters from the surface.*

Mounting height: 10 meters (33 feet)



Total lumen output:

2877 lm

Peak candela output:

1067 cd

**PRODUCT NAME:**

ECLPANEL TWCJR

**MEASUREMENT CONDITIONS:**

Beam angle:

Filter LD

Target:

Red

Operator:

Paolo Carvone

Date and time:

14/05/2020 15:38:03

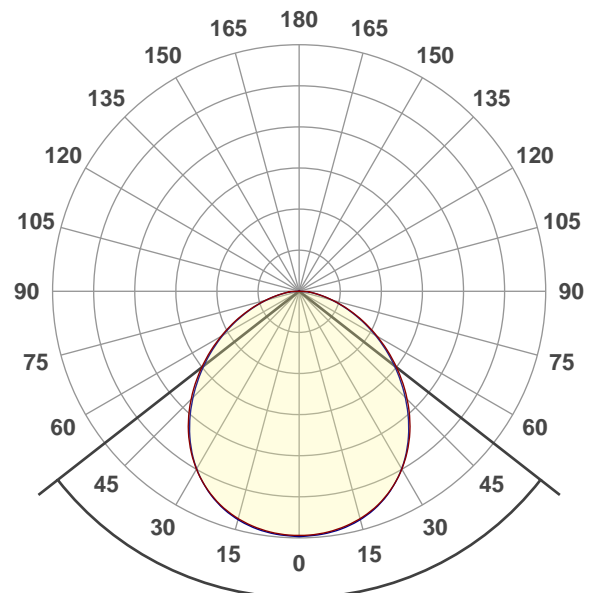

Beam angle 50%: 104°

Field angle 10%: 156,9°

Cut off angle 2.5%: 174,5°

Spectra

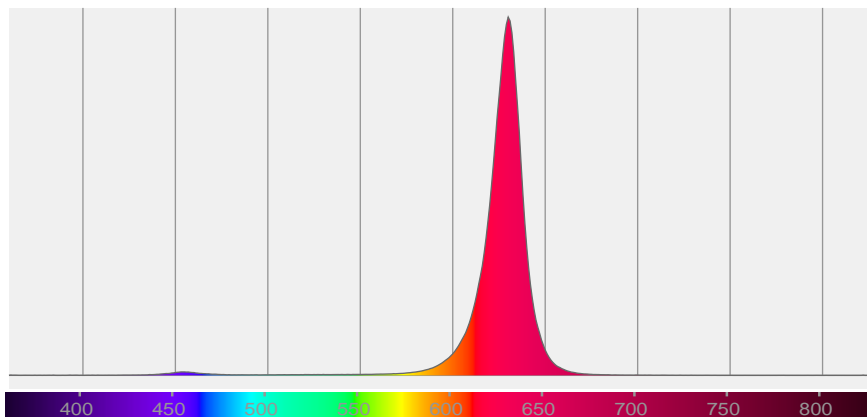

# BEAM DETAILS



Beam angle 50%	Field angle 10%	Cut off angle 2,5%	Intensity ratio in 120° cone	Intensity ratio in 90° cone
104°	156,9°	174,5°	79,2%	55,8%

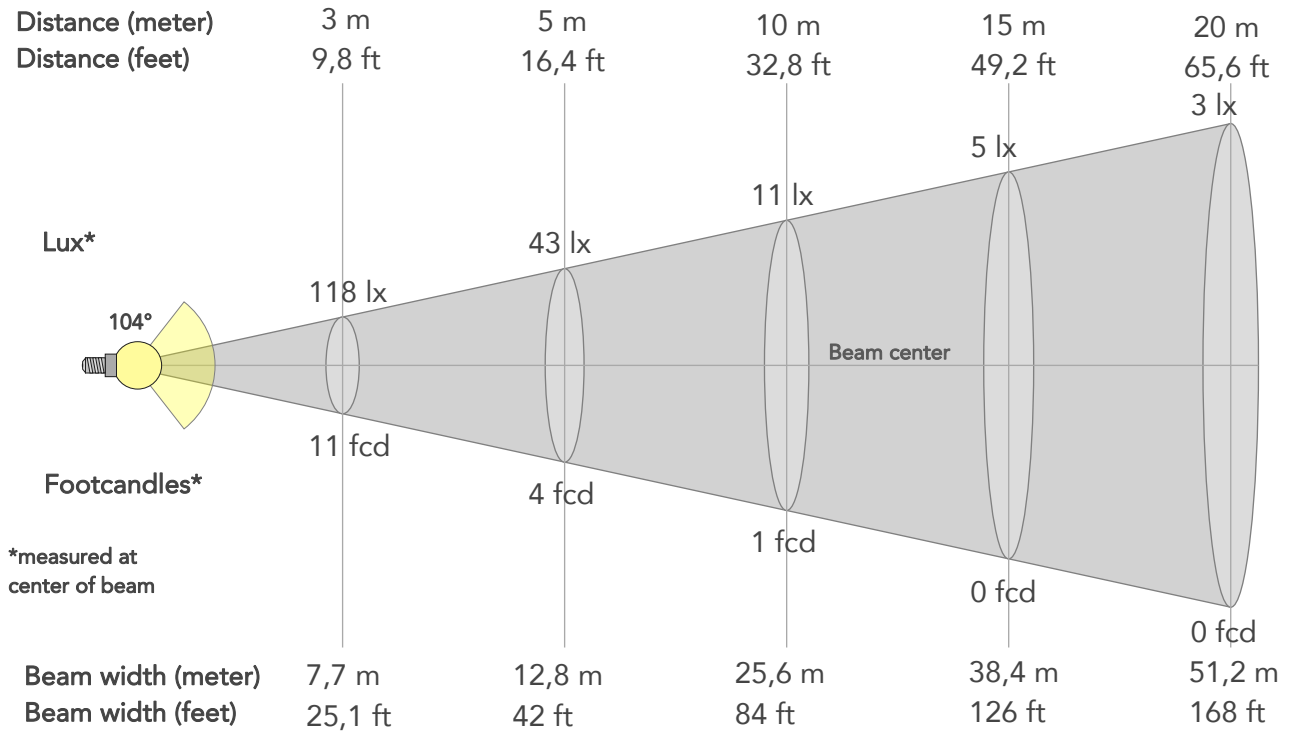

## BEAM INTENSITIES AND WIDTHS

Distance	1m	2m	3m	4m	5m	7,5m	10m	15m	20m	25m	30m	40m	50m
Distance	3,3ft	6,6ft	9,8ft	13,1ft	16,4ft	24,6ft	32,8ft	49,2ft	65,6ft	82ft	98,4ft	131,2ft	164ft
Lux	1065lx	266lx	118lx	67lx	43lx	19lx	11lx	5lx	3lx	2lx	1lx	1lx	0lx
Footcand.	99fcd	25fcd	11fcd	6fcd	4fcd	2fcd	1fcd	0fcd	0fcd	0fcd	0fcd	0fcd	0fcd
Beam wid.	2,6m	5,1m	7,7m	10,2m	12,8m	19,2m	25,6m	38,4m	51,2m	64m	76,8m	102,4m	128m
Beam wid.	8,4ft	16,9ft	25,1ft	33,5ft	42ft	63ft	84ft	126ft	168ft	210ft	252ft	335,9ft	419,9ft

## LINEAR DISTRIBUTION DIAGRAM

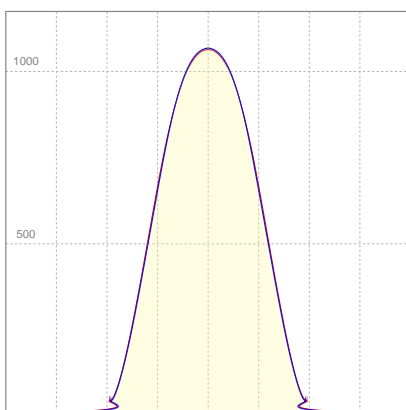

## ELECTRICAL SPECIFICATIONS

Input voltage	Input current	Input power	Effeciency
227V	0,384A	76,4W	38lm/W



## ISO CANDELA DIAGRAM

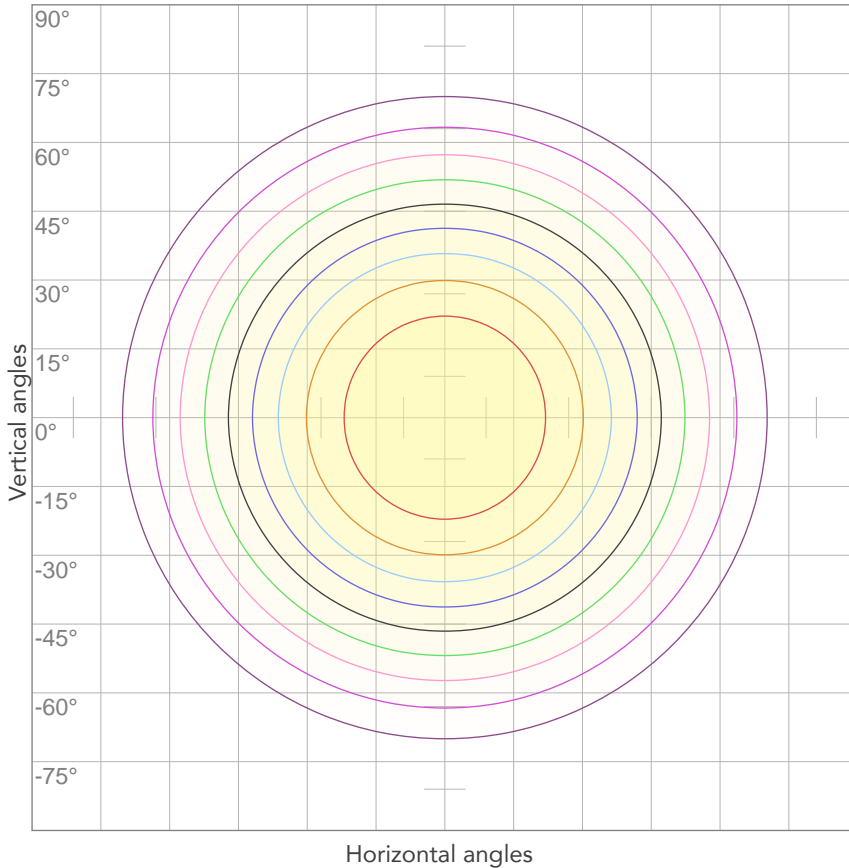

10%	107 cd
20%	213 cd
30%	320 cd
40%	426 cd
50%	533 cd
60%	639 cd
70%	746 cd
80%	852 cd

Conditions:

Number of c-planes: 4

Candela at center: 1065 cd

## ISO LUX DIAGRAM

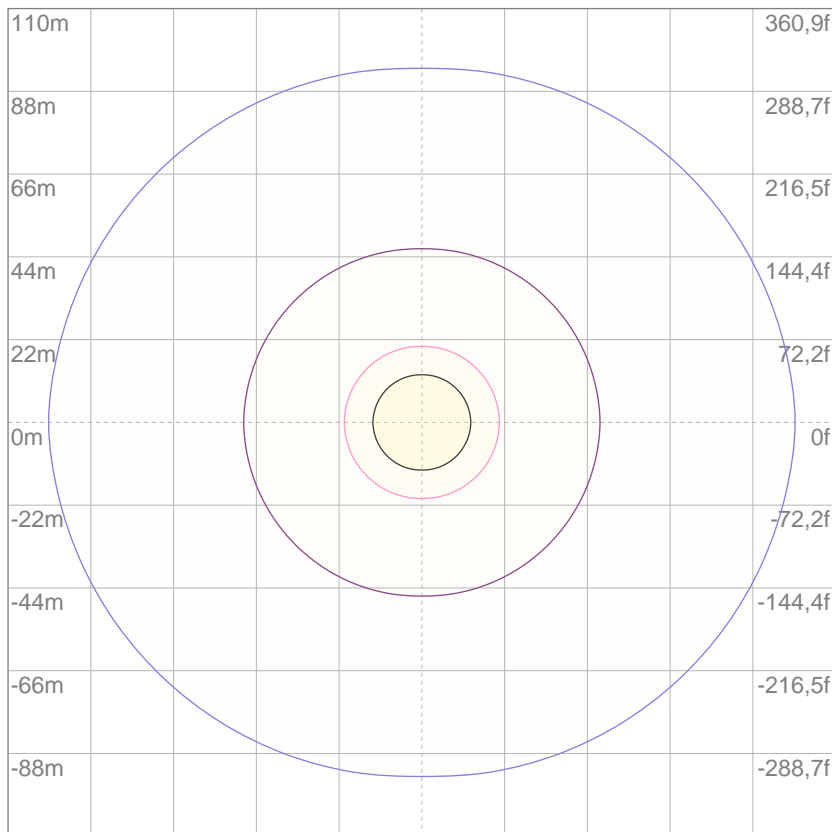

3%	0,320 lx
5%	0,533 lx
10%	1,07 lx
30%	3,20 lx
50%	5,33 lx

Conditions:

Number of c-planes: 4

Lux at center: 10,7 lx

*Lux distribution on a surface when lamp is mounted at 10 meters from the surface.*

Mounting height: 10 meters (33 feet)



Total lumen output:

3016 lm

Peak candela output:

1979 cd

**PRODUCT NAME:**

ECLPANEL TWCJR

**MEASUREMENT CONDITIONS:**

Beam angle:

Filter INT

Target:

Red

Operator:

Paolo Carvone

Date and time:

13/11/2020 11:51:03

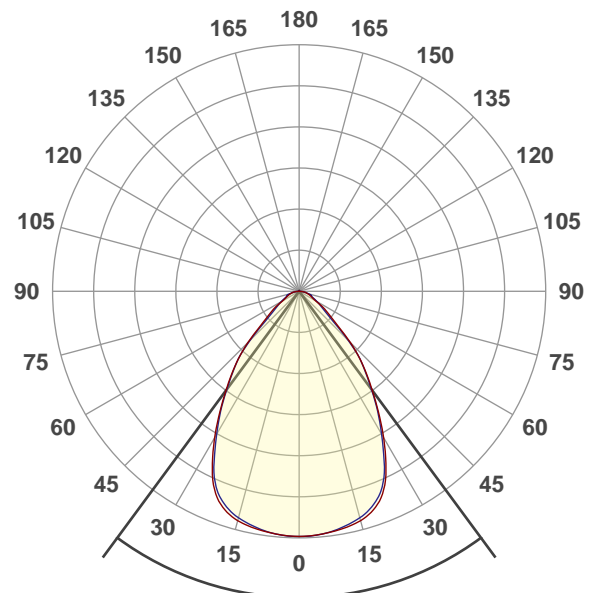

Beam angle 50%: 72,8°

Field angle 10%: 114,8°

Cut off angle 2.5%: 160,2°

Spectra

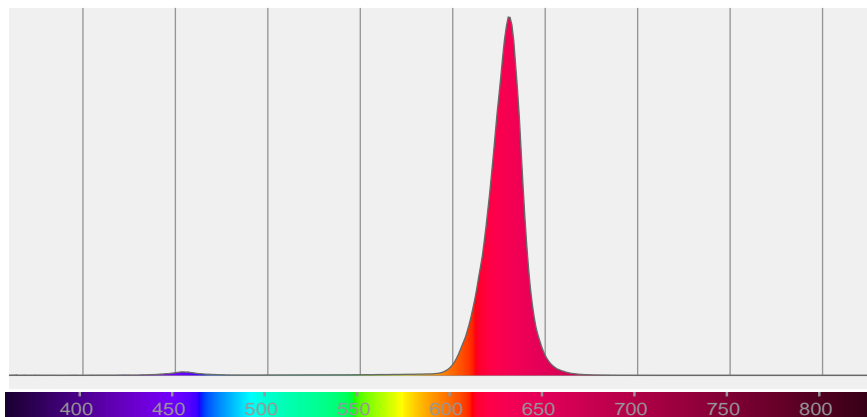

# BEAM DETAILS



Beam angle 50%	Field angle 10%	Cut off angle 2,5%	Intensity ratio in 120° cone	Intensity ratio in 90° cone
72,8°	114,8°	160,2°	92,3%	79,2%

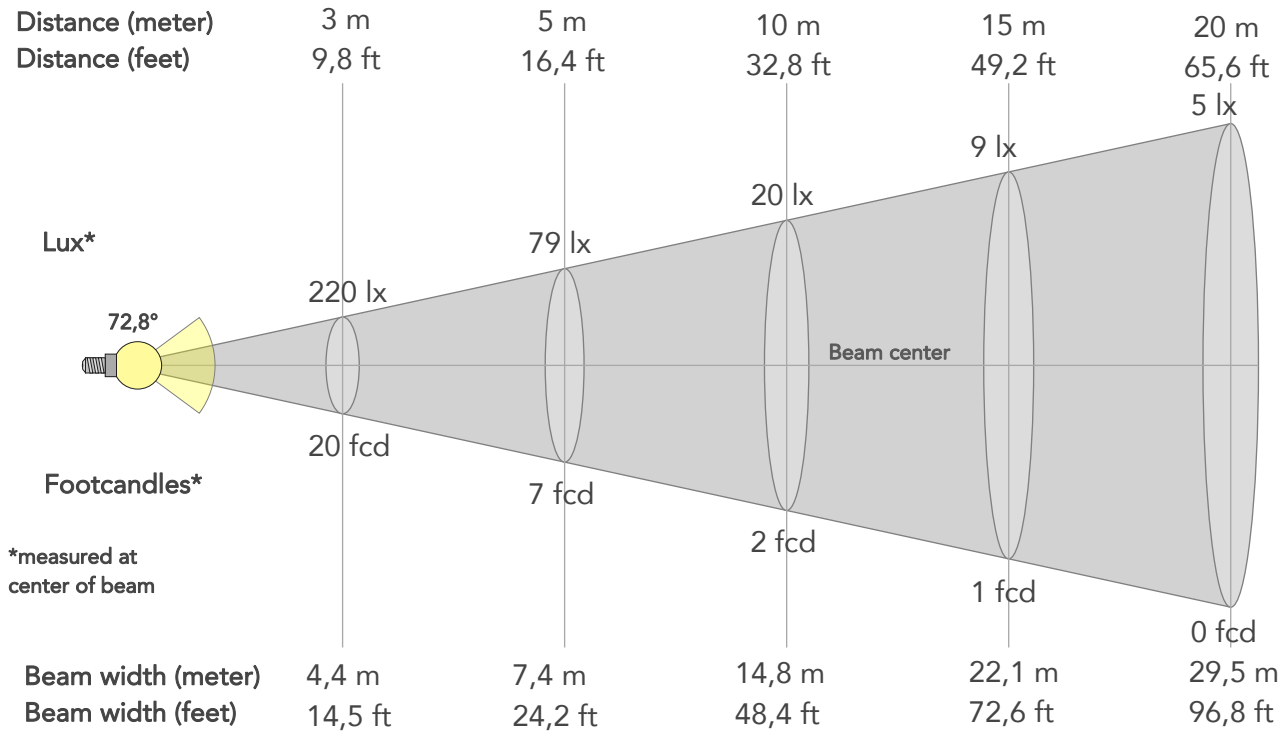

## BEAM INTENSITIES AND WIDTHS

Distance	1m	2m	3m	4m	5m	7,5m	10m	15m	20m	25m	30m	40m	50m
Distance	3,3ft	6,6ft	9,8ft	13,1ft	16,4ft	24,6ft	32,8ft	49,2ft	65,6ft	82ft	98,4ft	131,2ft	164ft
Lux	1979lx	495lx	220lx	124lx	79lx	35lx	20lx	9lx	5lx	3lx	2lx	1lx	1lx
Footcand.	184fcd	46fcd	20fcd	11fcd	7fcd	3fcd	2fcd	1fcd	0fcd	0fcd	0fcd	0fcd	0fcd
Beam wid.	1,5m	3m	4,4m	5,9m	7,4m	11,1m	14,8m	22,1m	29,5m	36,9m	44,3m	59m	73,8m
Beam wid.	4,9ft	9,7ft	14,5ft	19,3ft	24,2ft	36,3ft	48,4ft	72,6ft	96,8ft	121ft	145,2ft	193,6ft	241,9ft

## LINEAR DISTRIBUTION DIAGRAM

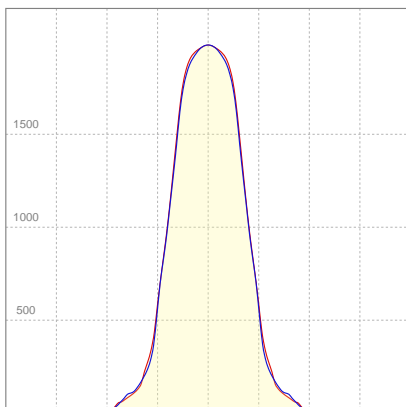

## ELECTRICAL SPECIFICATIONS

Input voltage	Input current	Input power	Effeciency
225V	0,466A	83,7W	36lm/W

Power FC
0,8

## ISO CANDELA DIAGRAM

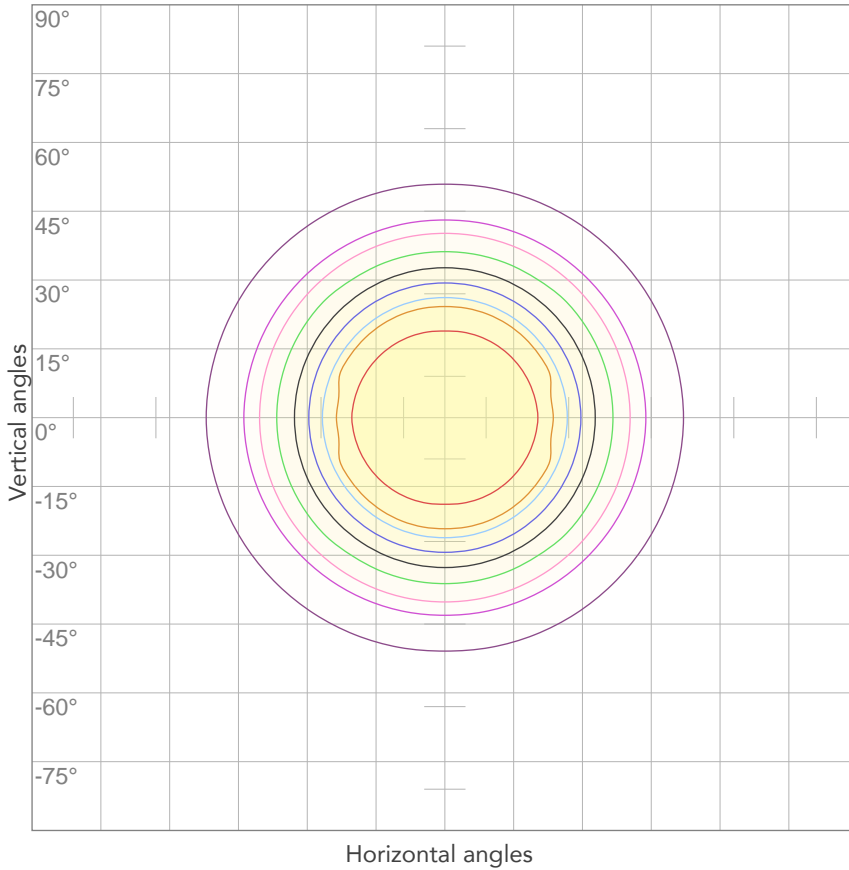

10%	198 cd
20%	396 cd
30%	594 cd
40%	792 cd
50%	989 cd
60%	1187 cd
70%	1385 cd
80%	1583 cd

Conditions:

Number of c-planes: 4

Candela at center: 1979 cd

## ISO LUX DIAGRAM

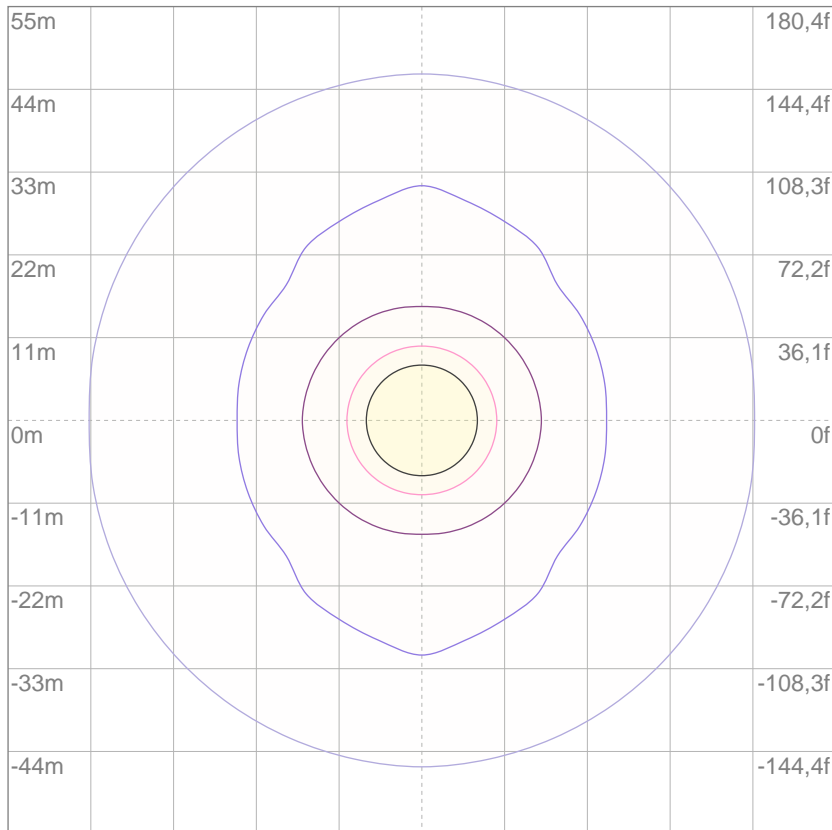

3%	0,594 lx
5%	0,989 lx
10%	1,98 lx
30%	5,94 lx
50%	9,89 lx

Conditions:

Number of c-planes: 4

Lux at center: 19,8 lx

*Lux distribution on a surface when lamp is mounted at 10 meters from the surface.*

Mounting height: 10 meters (33 feet)



Total lumen output:

6547 lm

Peak candela output:

2258 cd

**PRODUCT NAME:**

ECLPANEL TWCJR

**MEASUREMENT CONDITIONS:**

Beam angle:

Filter HD

Target:

Green

Operator:

Paolo Carvone

Date and time:

14/05/2020 16:13:50

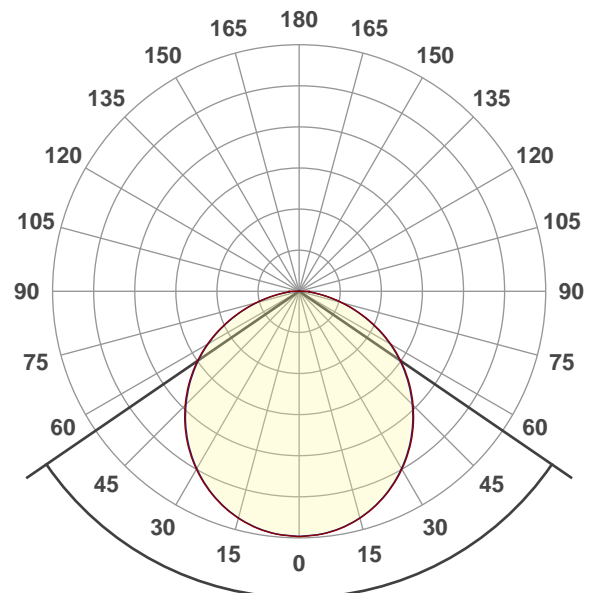

Beam angle 50%: 111,2°

Field angle 10%: 161°

Cut off angle 2.5%: 176,9°

Spectra

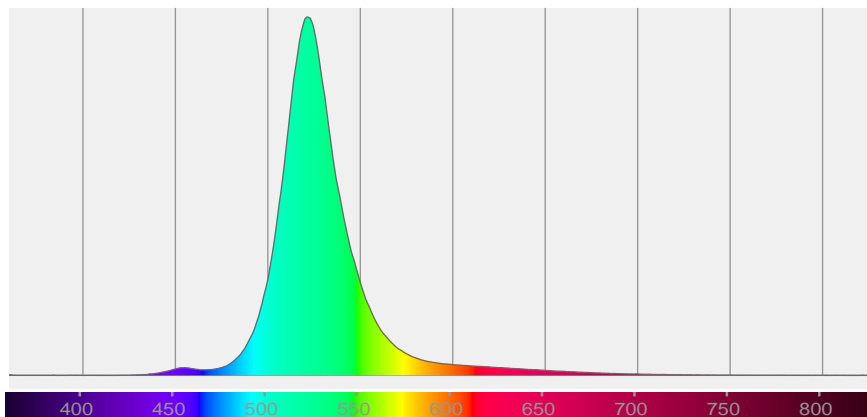

# BEAM DETAILS



Beam angle 50%	Field angle 10%	Cut off angle 2,5%	Intensity ratio in 120° cone	Intensity ratio in 90° cone
111,2°	161°	176,9°	76,6%	52,3%

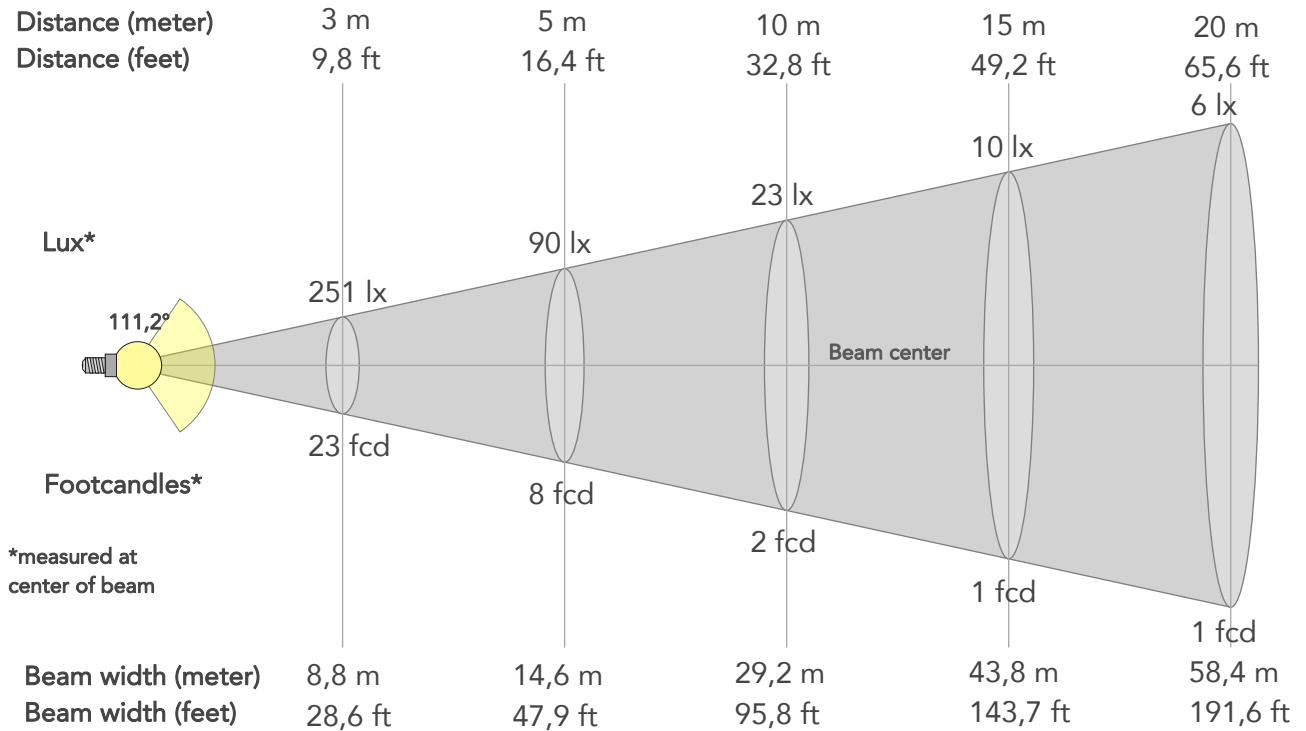

## BEAM INTENSITIES AND WIDTHS

Distance	1m	2m	3m	4m	5m	7,5m	10m	15m	20m	25m	30m	40m	50m
Distance	3,3ft	6,6ft	9,8ft	13,1ft	16,4ft	24,6ft	32,8ft	49,2ft	65,6ft	82ft	98,4ft	131,2ft	164ft
Lux	2256lx	564lx	251lx	141lx	90lx	40lx	23lx	10lx	6lx	4lx	3lx	1lx	1lx
Footcand.	210fcd	52fcd	23fcd	13fcd	8fcd	4fcd	2fcd	1fcd	1fcd	0fcd	0fcd	0fcd	0fcd
Beam wid.	2,9m	5,8m	8,8m	11,7m	14,6m	21,9m	29,2m	43,8m	58,4m	73m	87,6m	116,8m	146m
Beam wid.	9,6ft	19,3ft	28,6ft	38,3ft	47,9ft	71,8ft	95,8ft	143,7ft	191,6ft	239,5ft	287,4ft	383,2ft	479ft

## LINEAR DISTRIBUTION DIAGRAM

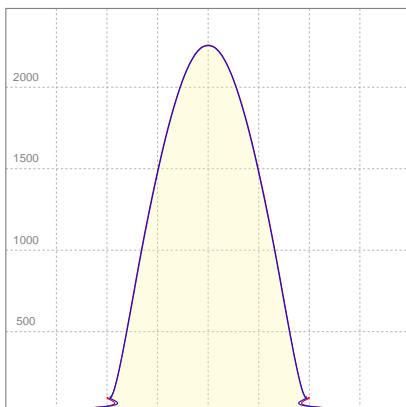

## ELECTRICAL SPECIFICATIONS

Input voltage	Input current	Input power	Effeciency
226V	0,515A	108,2W	60lm/W

## ISO CANDELA DIAGRAM



10%	226 cd
20%	451 cd
30%	677 cd
40%	903 cd
50%	1128 cd
60%	1354 cd
70%	1579 cd
80%	1805 cd

Conditions:

Number of c-planes: 4

Candela at center: 2256 cd

## ISO LUX DIAGRAM

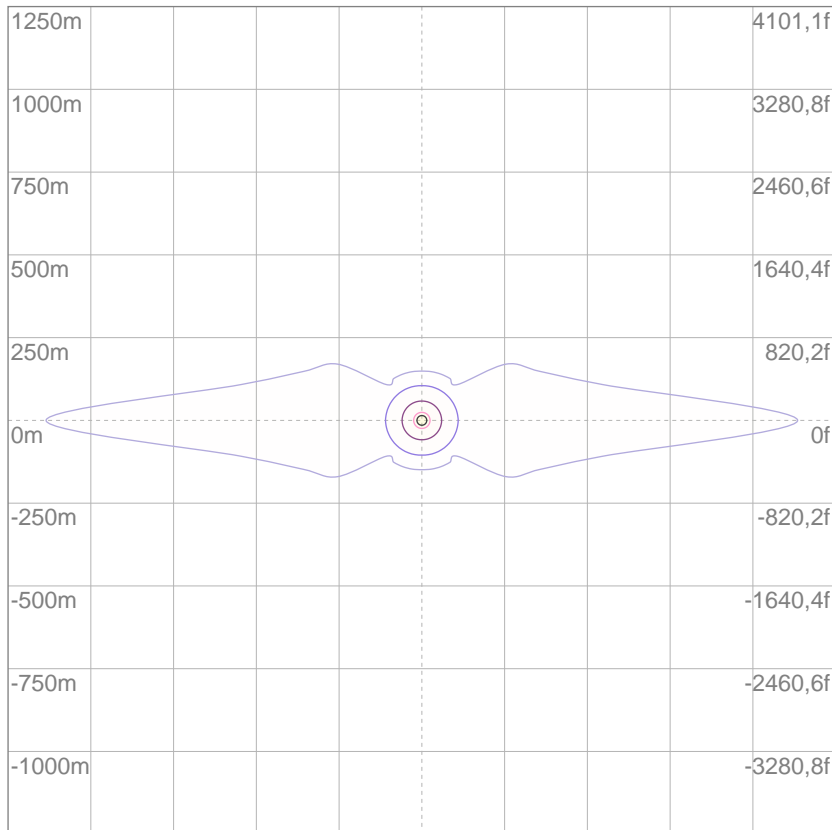

Mounting height: 10 meters (33 feet)

3%	0,677 lx
5%	1,13 lx
10%	2,26 lx
30%	6,77 lx
50%	11,3 lx

Conditions:

Number of c-planes: 4

Lux at center: 22,6 lx

*Lux distribution on a surface when lamp is mounted at 10 meters from the surface.*



Total lumen output:

7666 lm

Peak candela output:

2879 cd

**PRODUCT NAME:**

ECLPANEL TWCJR

**MEASUREMENT CONDITIONS:**

Beam angle:

Filter MD

Target:

Green

Operator:

Paolo Carvone

Date and time:

14/05/2020 15:57:47

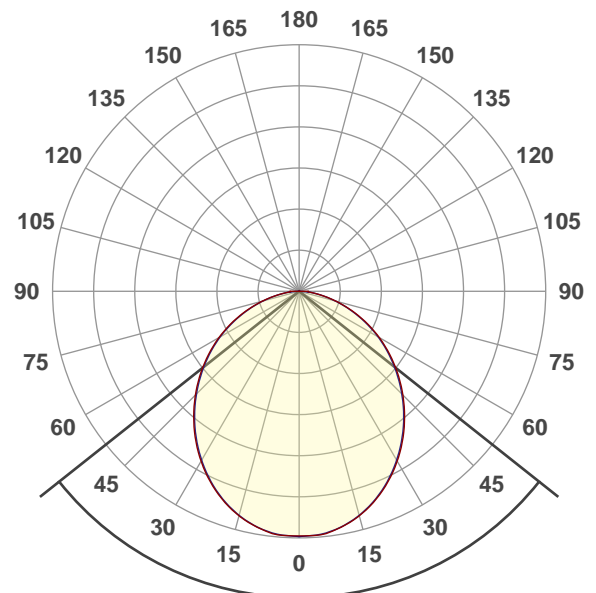

Beam angle 50%: 103,2°

Field angle 10%: 158,4°

Cut off angle 2.5%: 176,3°

Spectra

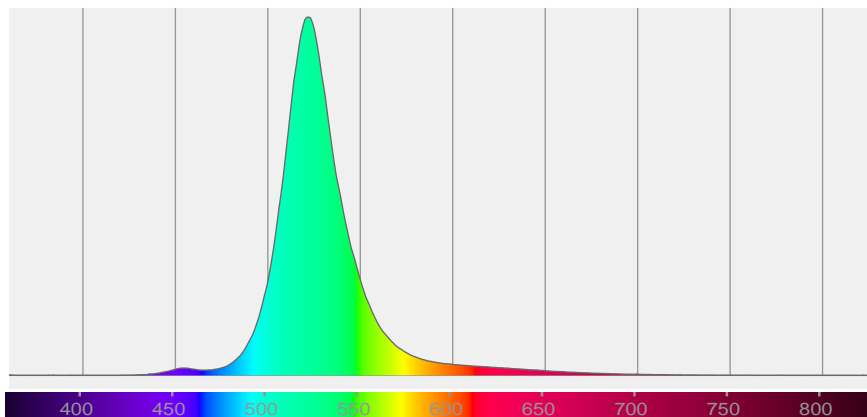



# BEAM DETAILS



Beam angle 50%	Field angle 10%	Cut off angle 2,5%	Intensity ratio in 120° cone	Intensity ratio in 90° cone
103,2°	158,4°	176,3°	77,9%	54,4%

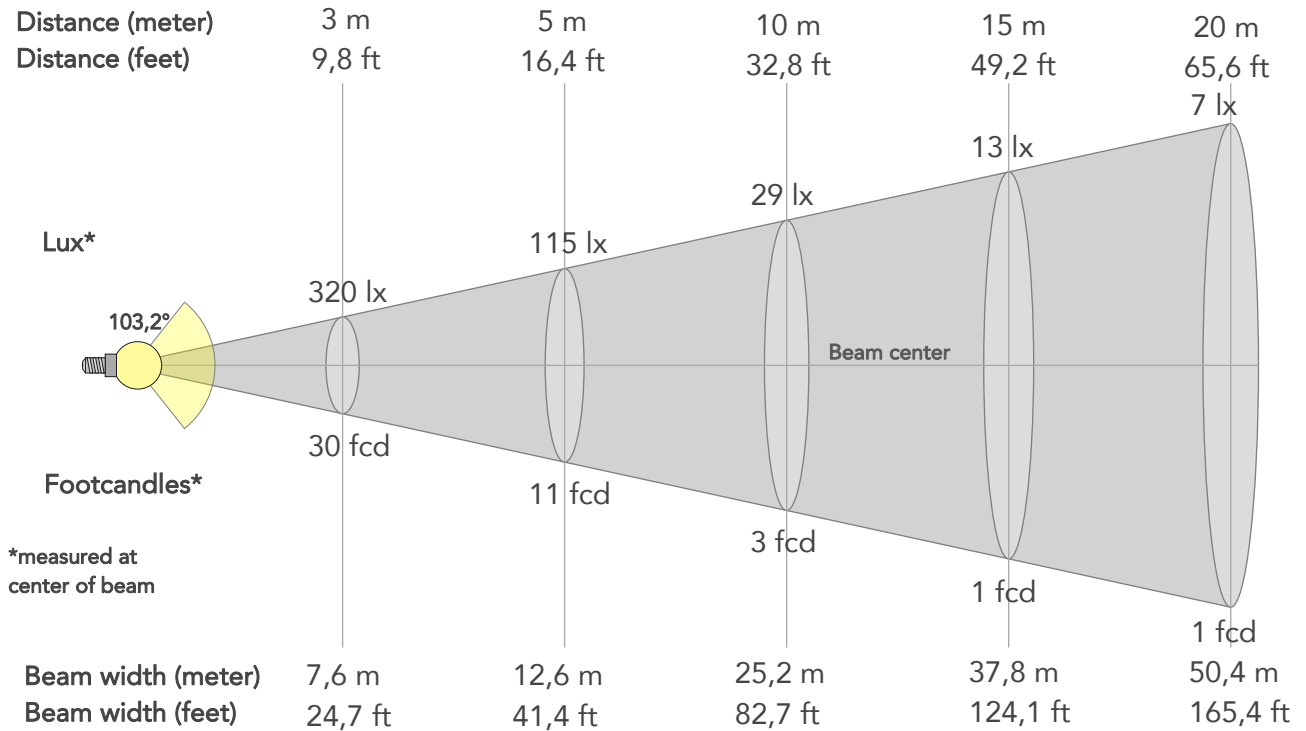

## BEAM INTENSITIES AND WIDTHS

Distance	1m	2m	3m	4m	5m	7,5m	10m	15m	20m	25m	30m	40m	50m
Distance	3,3ft	6,6ft	9,8ft	13,1ft	16,4ft	24,6ft	32,8ft	49,2ft	65,6ft	82ft	98,4ft	131,2ft	164ft
Lux	2876lx	719lx	320lx	180lx	115lx	51lx	29lx	13lx	7lx	5lx	3lx	2lx	1lx
Footcand.	267fcd	67fcd	30fcd	17fcd	11fcd	5fcd	3fcd	1fcd	1fcd	0fcd	0fcd	0fcd	0fcd
Beam wid.	2,5m	5m	7,6m	10,1m	12,6m	18,9m	25,2m	37,8m	50,4m	63m	75,6m	100,9m	126,1m
Beam wid.	8,3ft	16,6ft	24,7ft	33ft	41,4ft	62ft	82,7ft	124,1ft	165,4ft	206,8ft	248,1ft	330,8ft	413,5ft

## LINEAR DISTRIBUTION DIAGRAM

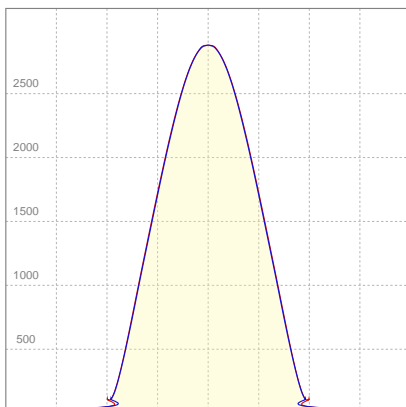

## ELECTRICAL SPECIFICATIONS

Input voltage	Input current	Input power	Effeciency
226V	0,514A	108,3W	71lm/W

## ISO CANDELA DIAGRAM

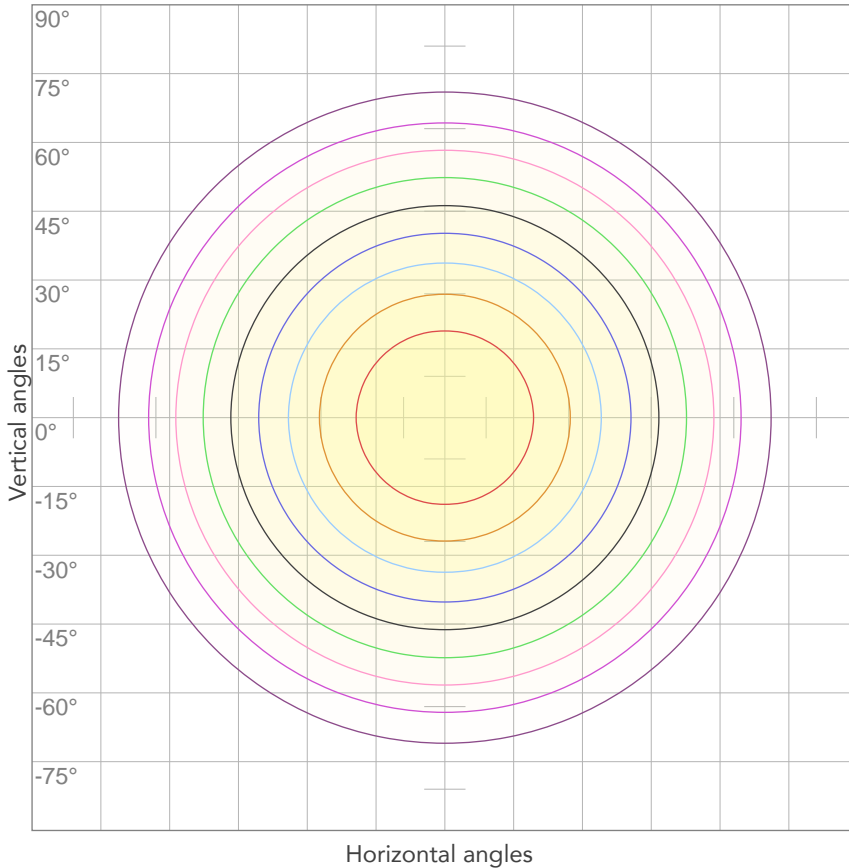

10%	288 cd
20%	575 cd
30%	863 cd
40%	1150 cd
50%	1438 cd
60%	1726 cd
70%	2013 cd
80%	2301 cd

Conditions:

Number of c-planes: 4

Candela at center: 2876 cd

## ISO LUX DIAGRAM

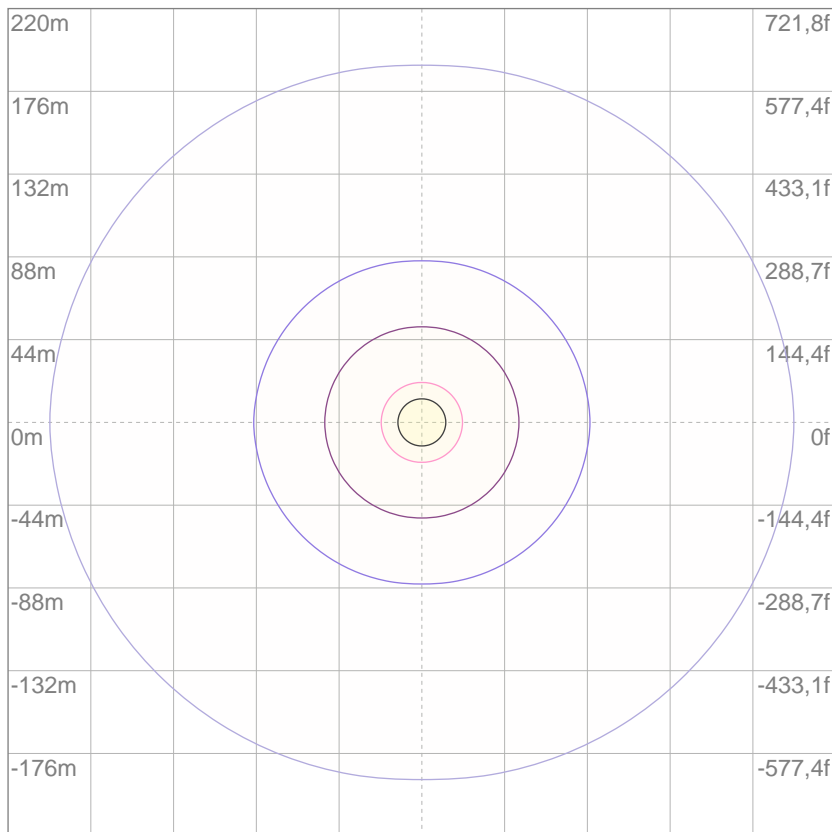

Mounting height: 10 meters (33 feet)

3%	0,863 lx
5%	1,44 lx
10%	2,88 lx
30%	8,63 lx
50%	14,4 lx

Conditions:

Number of c-planes: 4

Lux at center: 28,8 lx

*Lux distribution on a surface when lamp is mounted at 10 meters from the surface.*



Total lumen output:

7743 lm

Peak candela output:

2922 cd

PRODUCT NAME:

ECLPANEL TWCJR

MEASUREMENT CONDITIONS:

Beam angle:

Filter LD

Target:

Green

Operator:

Paolo Carvone

Date and time:

14/05/2020 15:40:56

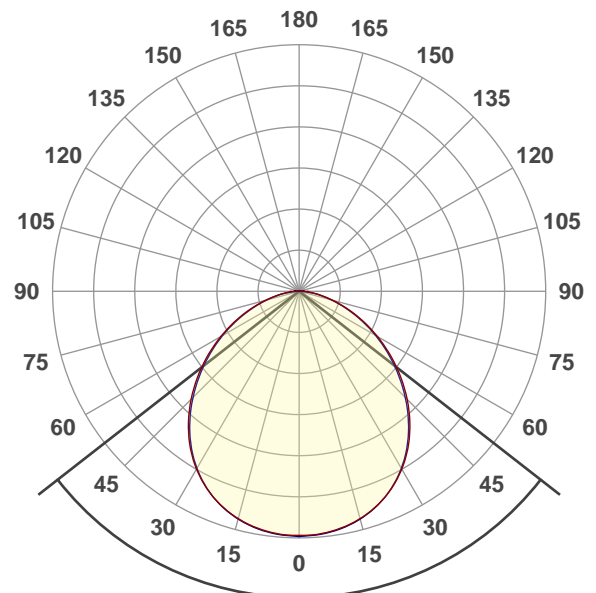

Beam angle 50%: 104,1°

Field angle 10%: 156,6°

Cut off angle 2.5%: 174°

Spectra

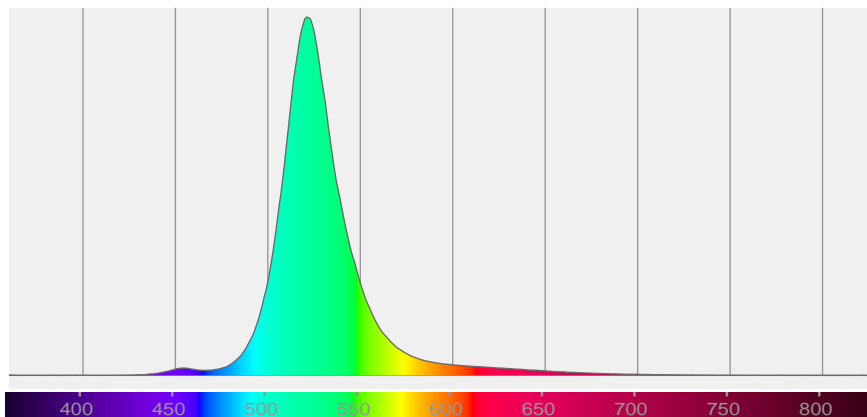

# BEAM DETAILS



Beam angle 50%	Field angle 10%	Cut off angle 2,5%	Intensity ratio in 120° cone	Intensity ratio in 90° cone
104,1°	156,6°	174°	80,5%	56,6%

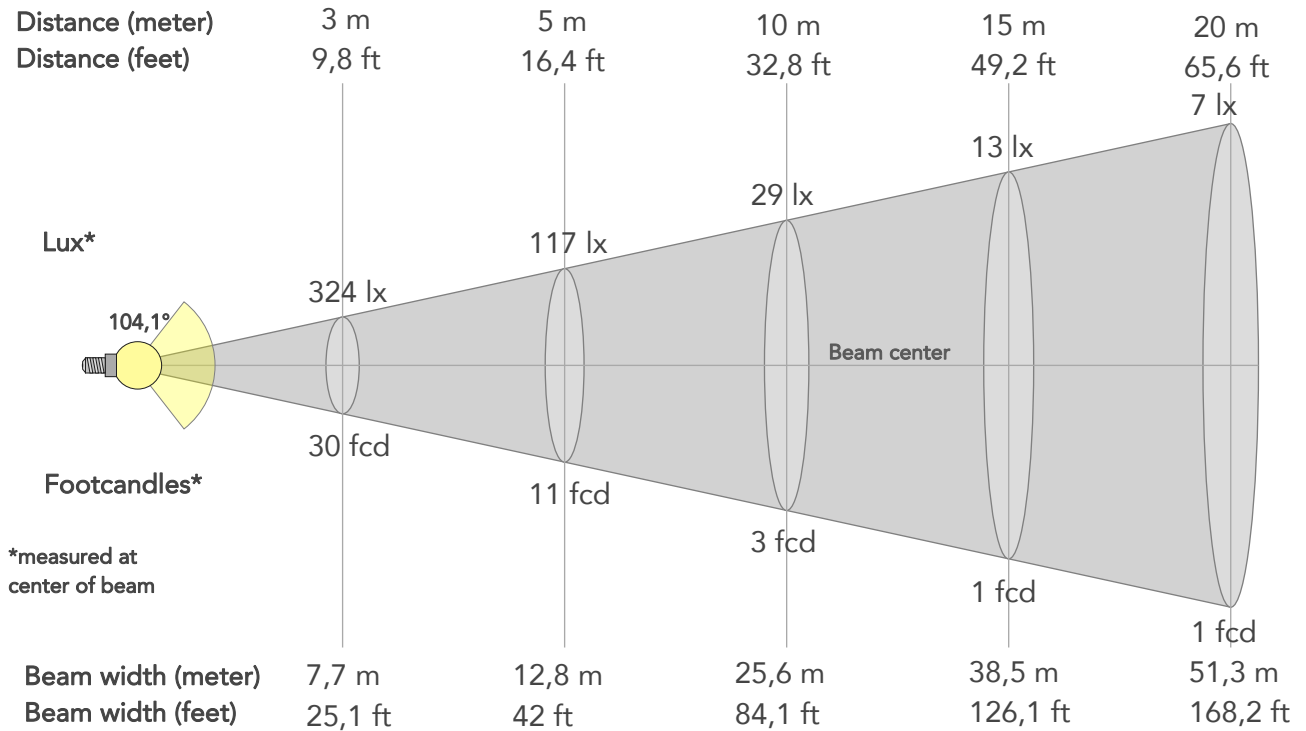

## BEAM INTENSITIES AND WIDTHS

Distance	1m	2m	3m	4m	5m	7,5m	10m	15m	20m	25m	30m	40m	50m
Distance	3,3ft	6,6ft	9,8ft	13,1ft	16,4ft	24,6ft	32,8ft	49,2ft	65,6ft	82ft	98,4ft	131,2ft	164ft
Lux	2915lx	729lx	324lx	182lx	117lx	52lx	29lx	13lx	7lx	5lx	3lx	2lx	1lx
Footcand.	271fcd	68fcd	30fcd	17fcd	11fcd	5fcd	3fcd	1fcd	1fcd	0fcd	0fcd	0fcd	0fcd
Beam wid.	2,6m	5,1m	7,7m	10,3m	12,8m	19,2m	25,6m	38,5m	51,3m	64,1m	76,9m	102,5m	128,2m
Beam wid.	8,5ft	16,9ft	25,1ft	33,6ft	42ft	63,1ft	84,1ft	126,1ft	168,2ft	210,2ft	252,3ft	336,3ft	420,4ft

## LINEAR DISTRIBUTION DIAGRAM

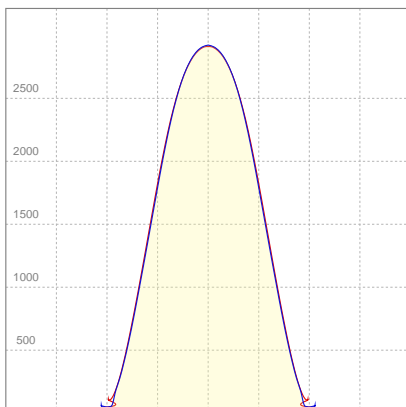

## ELECTRICAL SPECIFICATIONS

Input voltage	Input current	Input power	Effeciency
226V	0,516A	108,6W	71lm/W

## ISO CANDELA DIAGRAM

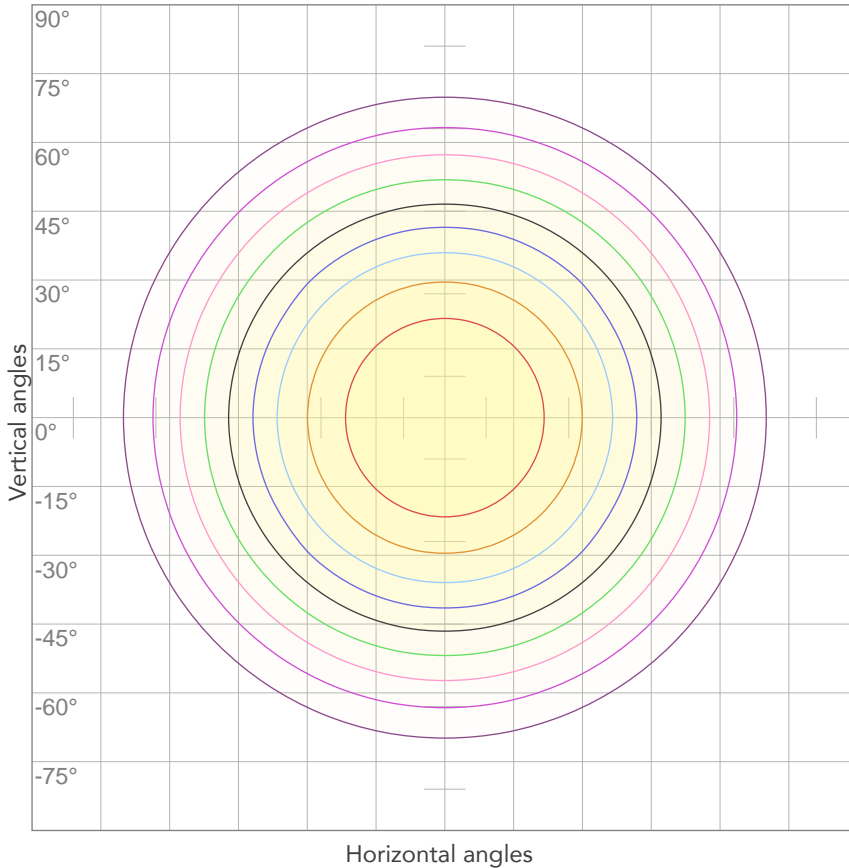

10%	292 cd
20%	583 cd
30%	875 cd
40%	1166 cd
50%	1458 cd
60%	1749 cd
70%	2041 cd
80%	2332 cd

Conditions:

Number of c-planes: 4

Candela at center: 2915 cd

## ISO LUX DIAGRAM

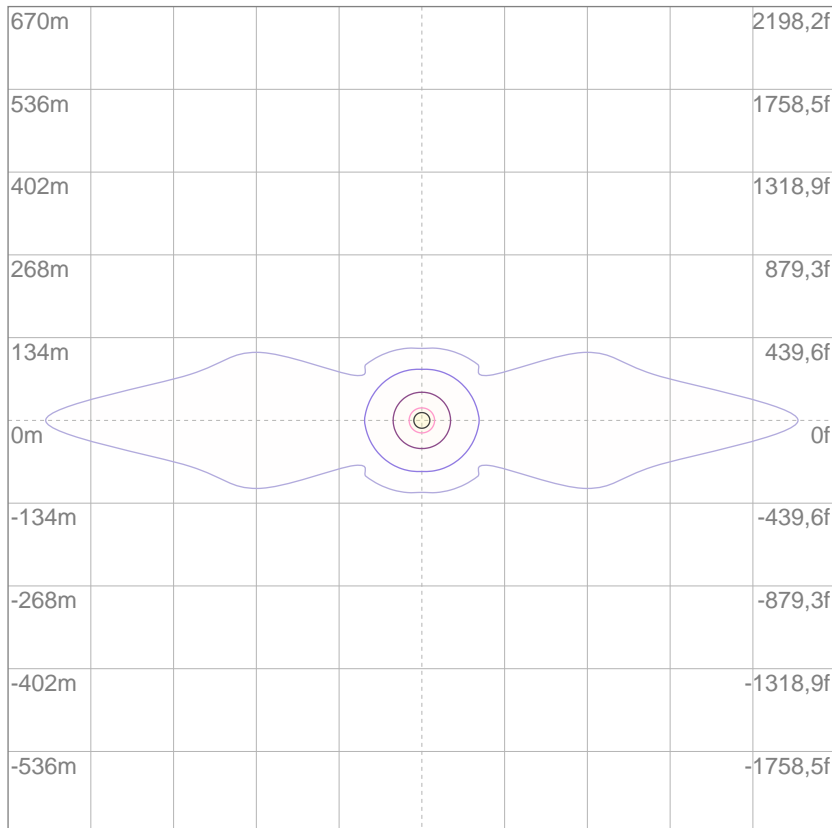

Mounting height: 10 meters (33 feet)

3%	0,875 lx
5%	1,46 lx
10%	2,92 lx
30%	8,75 lx
50%	14,6 lx

Conditions:

Number of c-planes: 4

Lux at center: 29,2 lx

*Lux distribution on a surface when lamp is mounted at 10 meters from the surface.*



Total lumen output:

6408 lm

Peak candela output:

4154 cd

**PRODUCT NAME:**  
ECLPANEL TWCJR

**MEASUREMENT CONDITIONS:**

Beam angle:  
Filter INT

Target:  
Green

Operator:  
Paolo Carvone

Date and time:  
13/11/2020 11:53:36

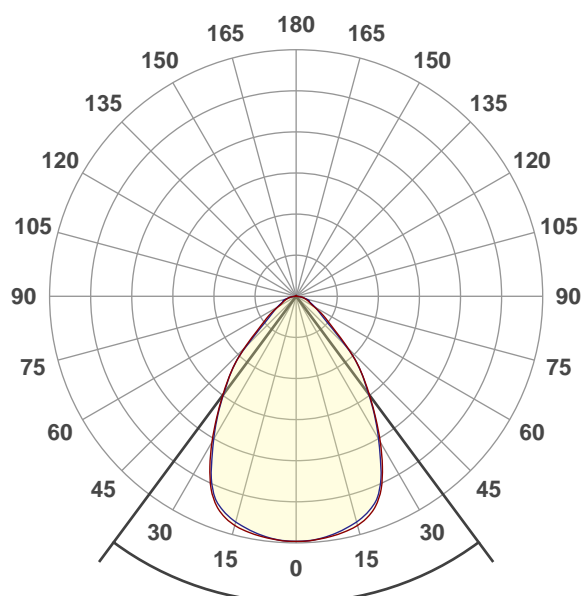

Beam angle 50%: 73,1°  
Field angle 10%: 116,2°  
Cut off angle 2.5%: 161,1°

Spectra

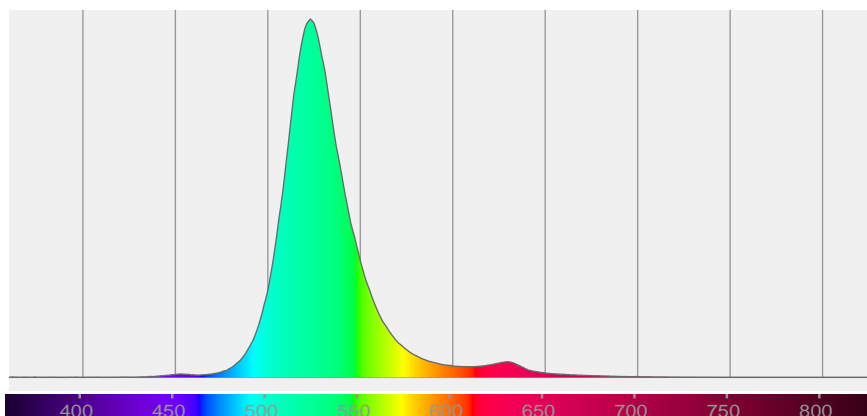

# BEAM DETAILS



Beam angle 50%	Field angle 10%	Cut off angle 2,5%	Intensity ratio in 120° cone	Intensity ratio in 90° cone
73,1°	116,2°	161,1°	91,8%	78,5%

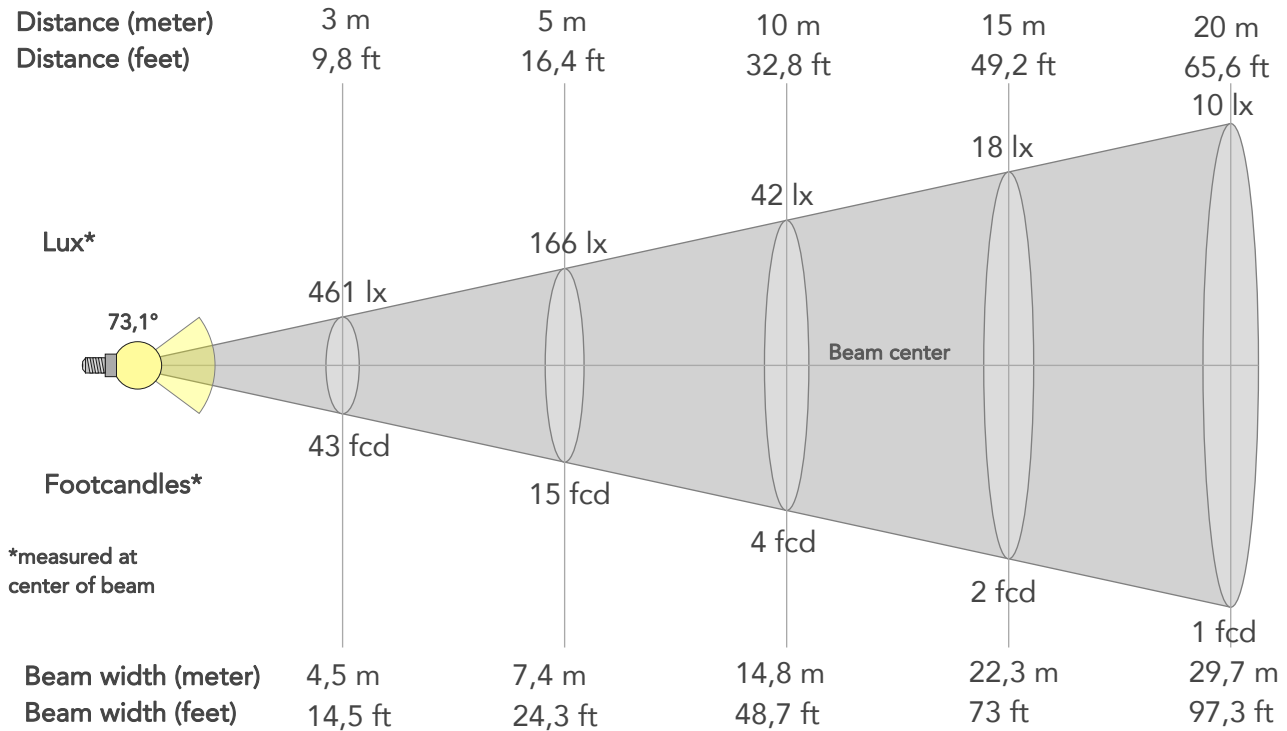

## BEAM INTENSITIES AND WIDTHS

Distance	1m	2m	3m	4m	5m	7,5m	10m	15m	20m	25m	30m	40m	50m
Distance	3,3ft	6,6ft	9,8ft	13,1ft	16,4ft	24,6ft	32,8ft	49,2ft	65,6ft	82ft	98,4ft	131,2ft	164ft
Lux	4153lx	1038lx	461lx	260lx	166lx	74lx	42lx	18lx	10lx	7lx	5lx	3lx	2lx
Footcand.	386fcd	96fcd	43fcd	24fcd	15fcd	7fcd	4fcd	2fcd	1fcd	1fcd	0fcd	0fcd	0fcd
Beam wid.	1,5m	3m	4,5m	5,9m	7,4m	11,1m	14,8m	22,3m	29,7m	37,1m	44,5m	59,4m	74,2m
Beam wid.	4,9ft	9,8ft	14,5ft	19,4ft	24,3ft	36,5ft	48,7ft	73ft	97,3ft	121,7ft	146ft	194,7ft	243,3ft

## LINEAR DISTRIBUTION DIAGRAM

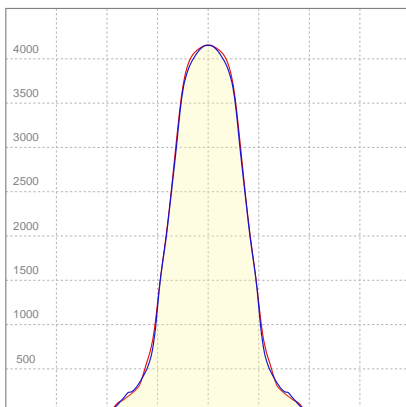

## ELECTRICAL SPECIFICATIONS

Input voltage	Input current	Input power	Effeciency
226V	0,561A	108,7W	59lm/W

Power FC
0,86

## ISO CANDELA DIAGRAM

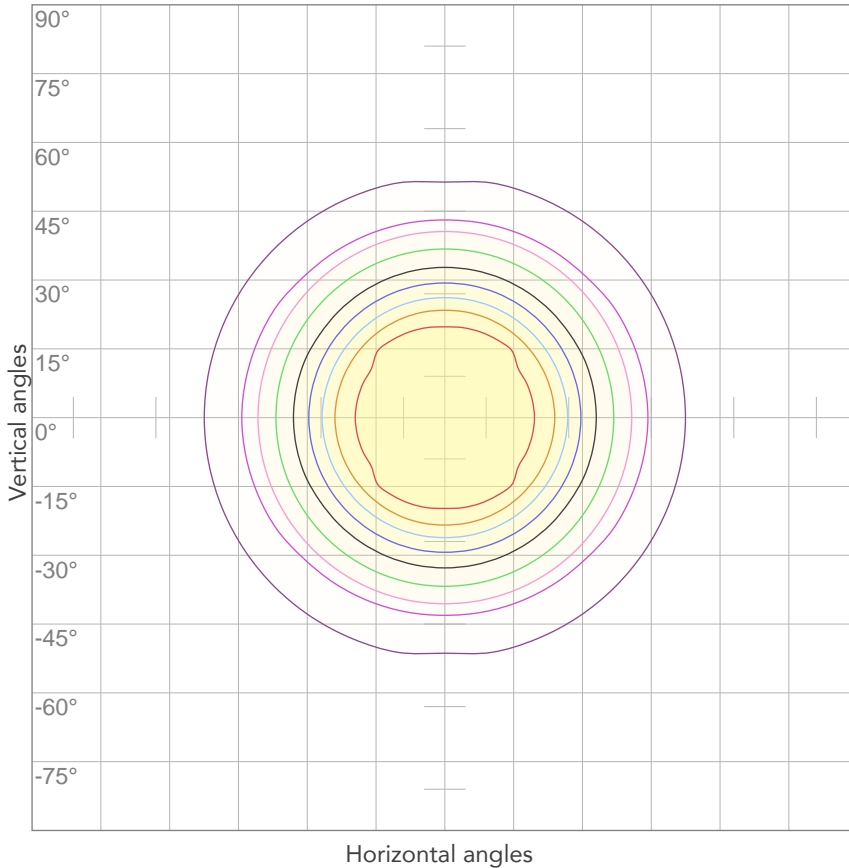

10%	415 cd
20%	831 cd
30%	1246 cd
40%	1661 cd
50%	2076 cd
60%	2492 cd
70%	2907 cd
80%	3322 cd

Conditions:

Number of c-planes: 4

Candela at center: 4153 cd

## ISO LUX DIAGRAM

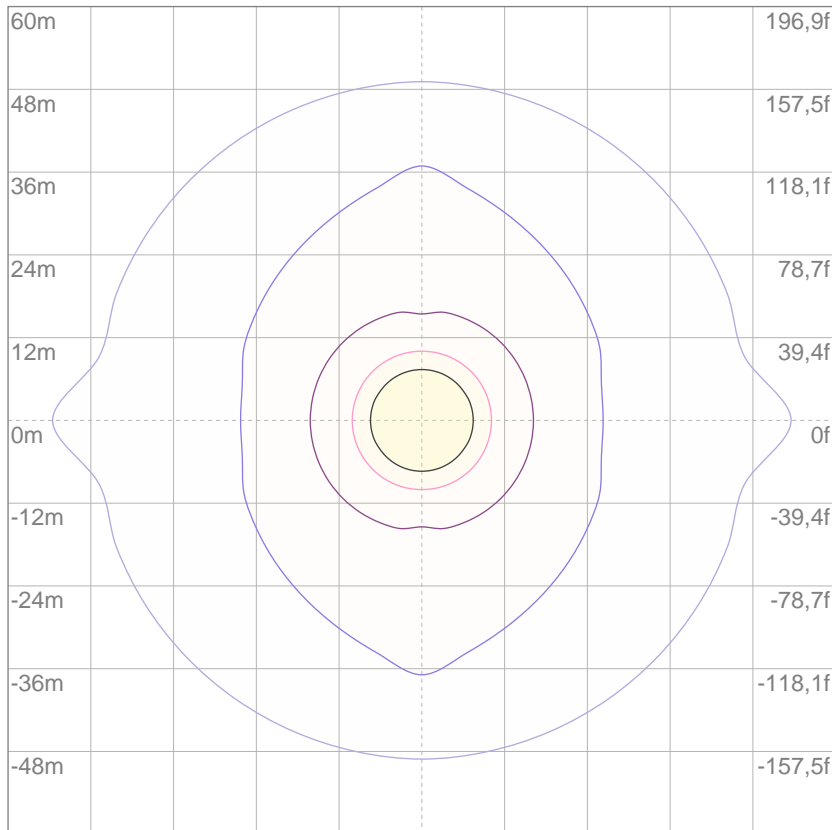

3%	1,25 lx
5%	2,08 lx
10%	4,15 lx
30%	12,5 lx
50%	20,8 lx

Conditions:

Number of c-planes: 4

Lux at center: 41,5 lx

*Lux distribution on a surface when lamp is mounted at 10 meters from the surface.*

Mounting height: 10 meters (33 feet)





Total lumen output:

1315 lm

Peak candela output:

464 cd

**PRODUCT NAME:**

ECLPANEL TWCJR

**MEASUREMENT CONDITIONS:**

Beam angle:

Filter HD

Target:

Blue

Operator:

Paolo Carvone

Date and time:

14/05/2020 16:17:53

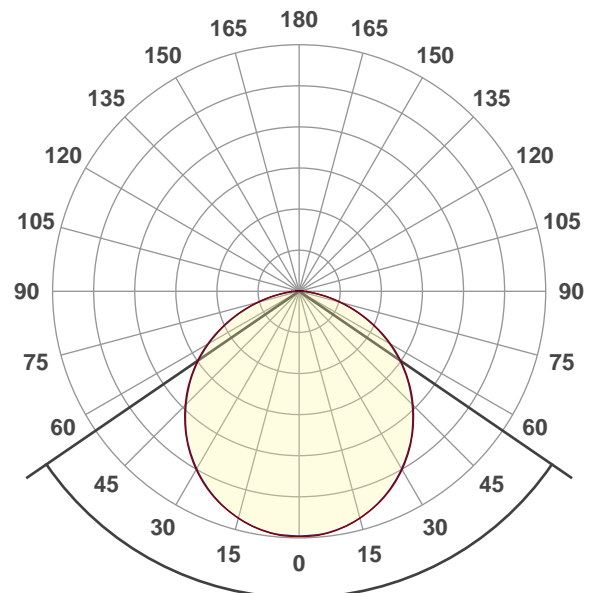

Beam angle 50%: 111,2°

Field angle 10%: 159,9°

Cut off angle 2.5%: 176,5°

Spectra

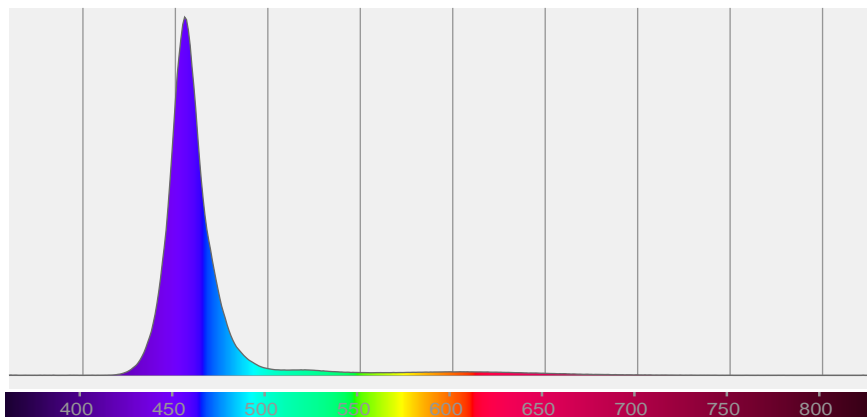

# BEAM DETAILS



Beam angle 50%	Field angle 10%	Cut off angle 2,5%	Intensity ratio in 120° cone	Intensity ratio in 90° cone
111,2°	159,9°	176,5°	78,5%	53,6%

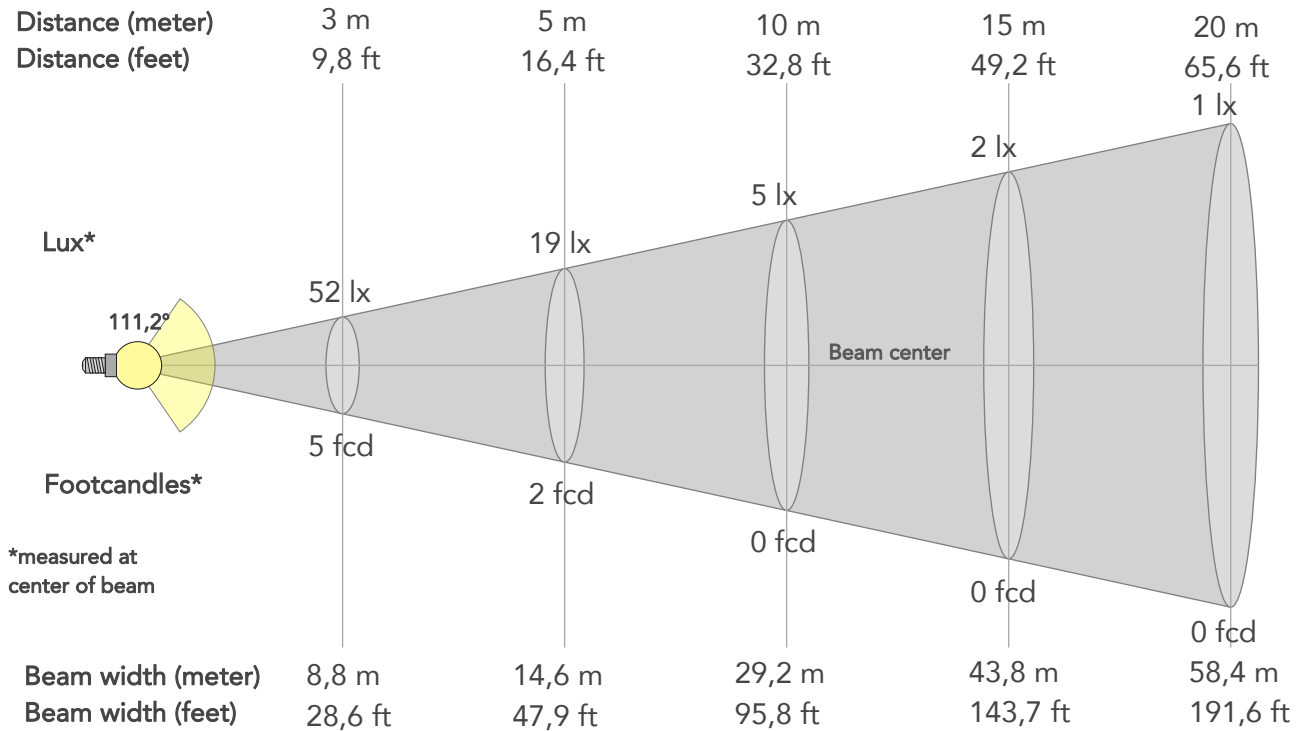

## BEAM INTENSITIES AND WIDTHS

Distance	1m	2m	3m	4m	5m	7,5m	10m	15m	20m	25m	30m	40m	50m
Distance	3,3ft	6,6ft	9,8ft	13,1ft	16,4ft	24,6ft	32,8ft	49,2ft	65,6ft	82ft	98,4ft	131,2ft	164ft
Lux	464lx	116lx	52lx	29lx	19lx	8lx	5lx	2lx	1lx	1lx	1lx	0lx	0lx
Footcand.	43fcd	11fcd	5fcd	3fcd	2fcd	1fcd	0fcd	0fcd	0fcd	0fcd	0fcd	0fcd	0fcd
Beam wid.	2,9m	5,8m	8,8m	11,7m	14,6m	21,9m	29,2m	43,8m	58,4m	73m	87,6m	116,8m	146m
Beam wid.	9,6ft	19,3ft	28,6ft	38,3ft	47,9ft	71,8ft	95,8ft	143,7ft	191,6ft	239,5ft	287,4ft	383,2ft	479ft

## LINEAR DISTRIBUTION DIAGRAM

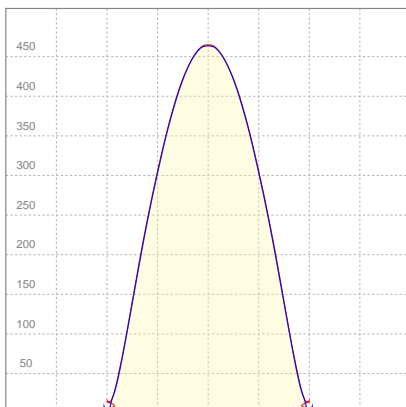

## ELECTRICAL SPECIFICATIONS

Input voltage	Input current	Input power	Effeciency
226V	0,347A	67,2W	20lm/W

## ISO CANDELA DIAGRAM

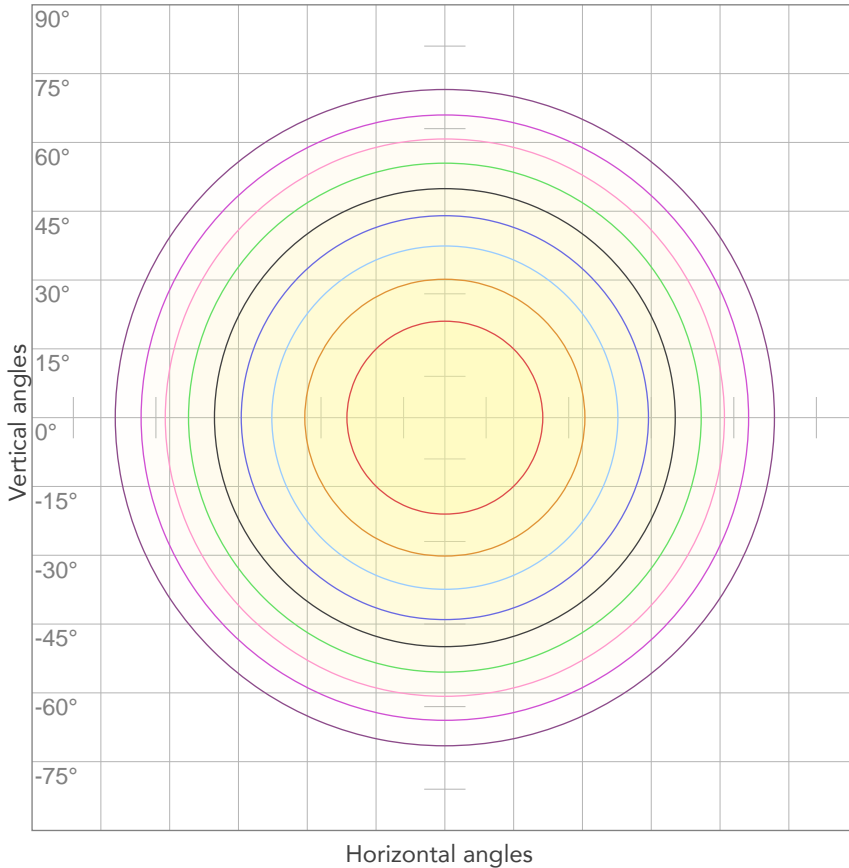

10%	46 cd
20%	93 cd
30%	139 cd
40%	186 cd
50%	232 cd
60%	278 cd
70%	325 cd
80%	371 cd

Conditions:

Number of c-planes: 4

Candela at center: 464 cd

## ISO LUX DIAGRAM

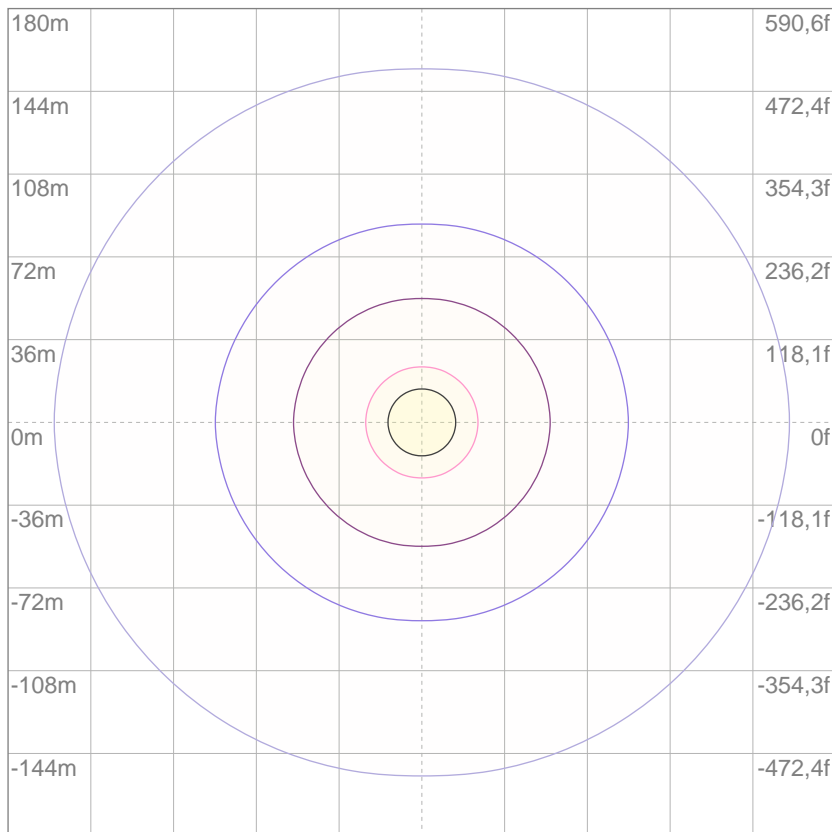

3%	0,139 lx
5%	0,232 lx
10%	0,464 lx
30%	1,39 lx
50%	2,32 lx

Conditions:

Number of c-planes: 4

Lux at center: 4,64 lx

*Lux distribution on a surface when lamp is mounted at 10 meters from the surface.*

Mounting height: 10 meters (33 feet)



Total lumen output:

1478 lm

Peak candela output:

569 cd

**PRODUCT NAME:**

ECLPANEL TWCJR

**MEASUREMENT CONDITIONS:**

Beam angle:

Filter MD

Target:

Blue

Operator:

Paolo Carvone

Date and time:

14/05/2020 15:59:38

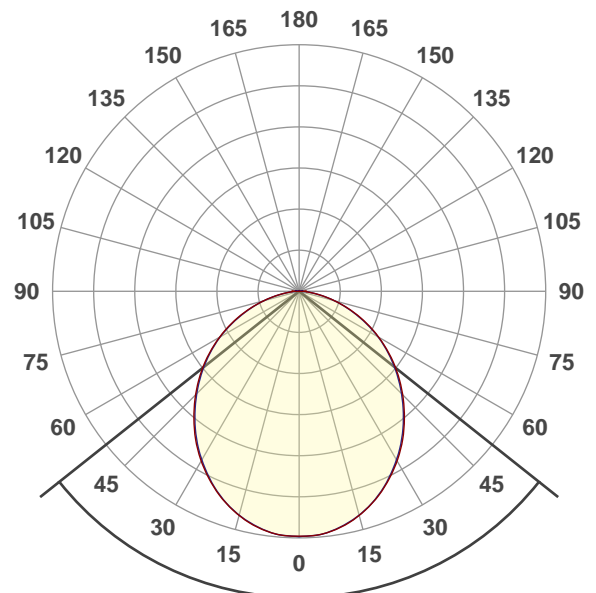

Beam angle 50%: 103,1°

Field angle 10%: 157,5°

Cut off angle 2.5%: 176,2°

Spectra

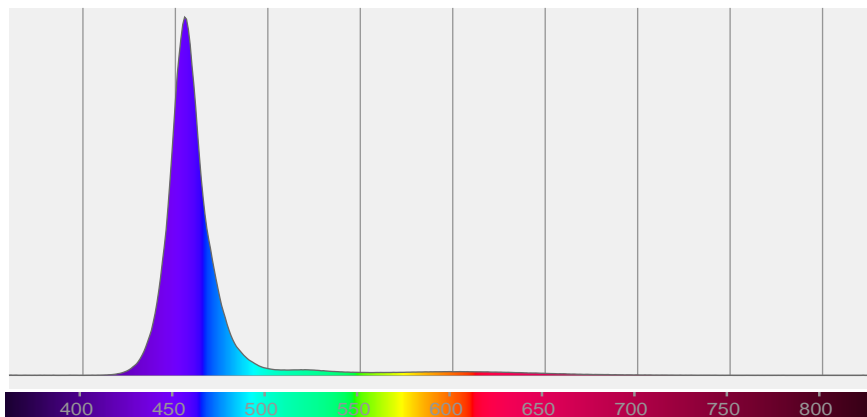

# BEAM DETAILS



Beam angle 50%	Field angle 10%	Cut off angle 2,5%	Intensity ratio in 120° cone	Intensity ratio in 90° cone
103,1°	157,5°	176,2°	79,7%	55,6%

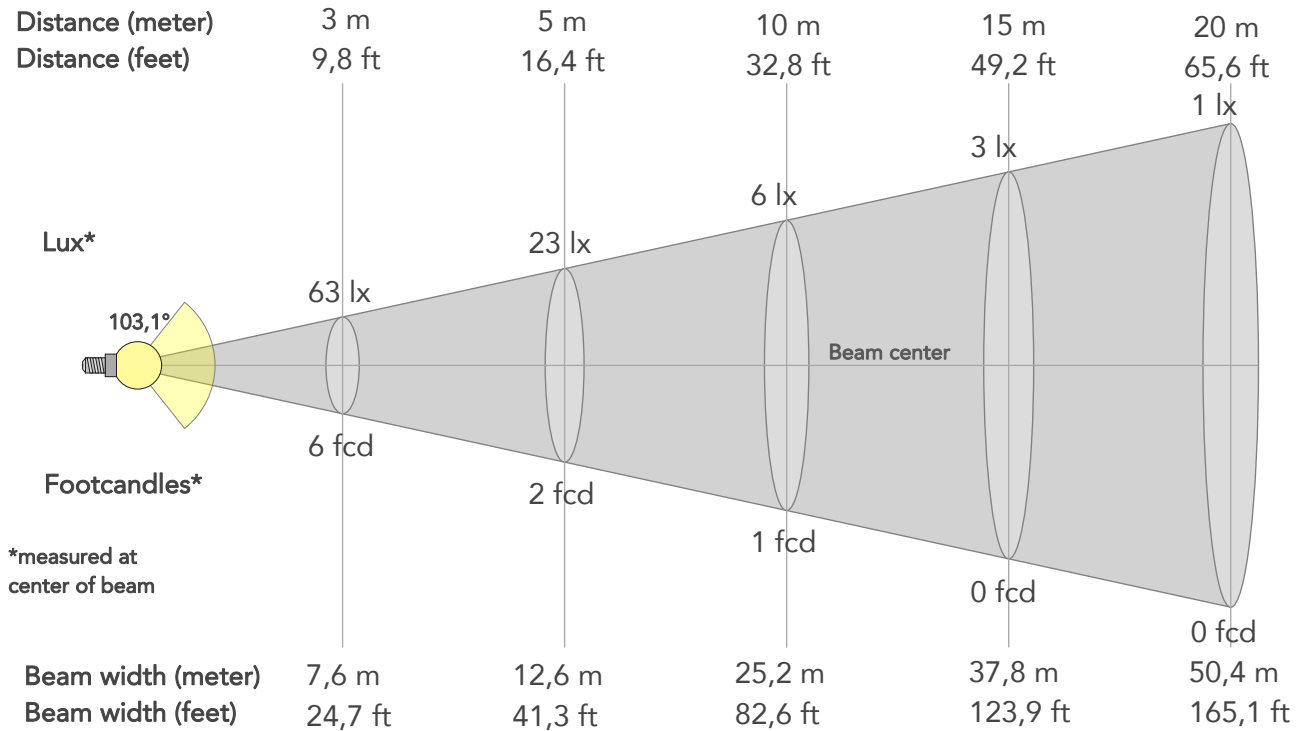

## BEAM INTENSITIES AND WIDTHS

Distance	1m	2m	3m	4m	5m	7,5m	10m	15m	20m	25m	30m	40m	50m
Distance	3,3ft	6,6ft	9,8ft	13,1ft	16,4ft	24,6ft	32,8ft	49,2ft	65,6ft	82ft	98,4ft	131,2ft	164ft
Lux	569lx	142lx	63lx	36lx	23lx	10lx	6lx	3lx	1lx	1lx	1lx	0lx	0lx
Footcand.	53fcd	13fcd	6fcd	3fcd	2fcd	1fcd	1fcd	0fcd	0fcd	0fcd	0fcd	0fcd	0fcd
Beam wid.	2,5m	5m	7,6m	10,1m	12,6m	18,9m	25,2m	37,8m	50,4m	62,9m	75,5m	100,7m	125,9m
Beam wid.	8,3ft	16,6ft	24,7ft	33ft	41,3ft	61,9ft	82,6ft	123,9ft	165,1ft	206,4ft	247,7ft	330,3ft	412,9ft

## LINEAR DISTRIBUTION DIAGRAM

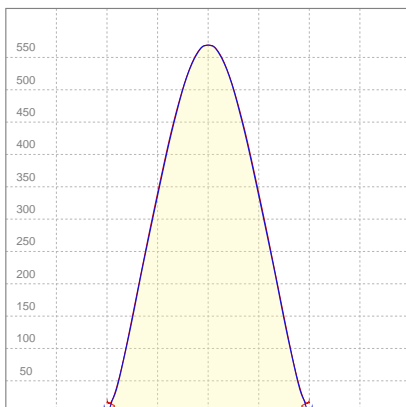

## ELECTRICAL SPECIFICATIONS

Input voltage	Input current	Input power	Effeciency
226V	0,346A	67,2W	22lm/W

## ISO CANDELA DIAGRAM

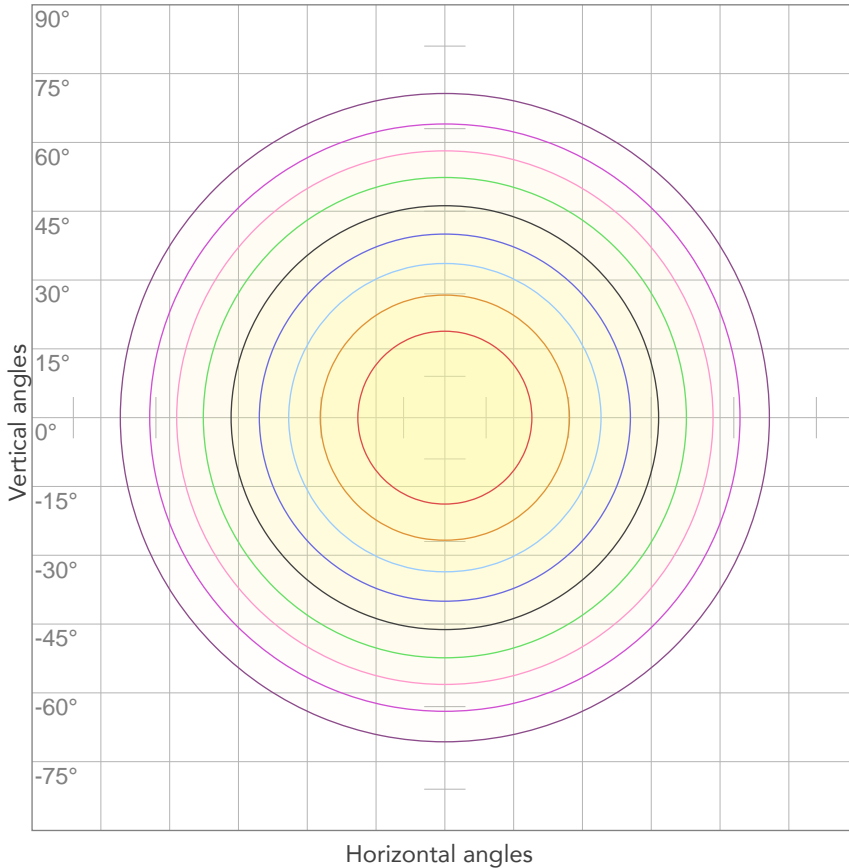

10%	57 cd
20%	114 cd
30%	171 cd
40%	227 cd
50%	284 cd
60%	341 cd
70%	398 cd
80%	455 cd

Conditions:

Number of c-planes: 4

Candela at center: 569 cd

## ISO LUX DIAGRAM

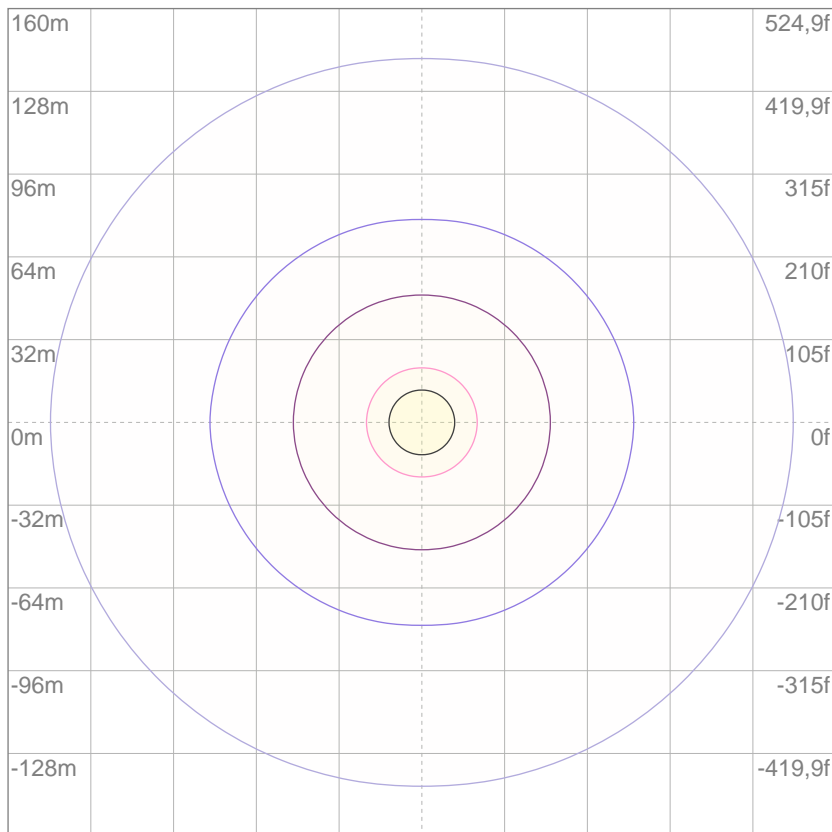

3%	0,171 lx
5%	0,284 lx
10%	0,569 lx
30%	1,71 lx
50%	2,84 lx

Conditions:

Number of c-planes: 4

Lux at center: 5,69 lx

*Lux distribution on a surface when lamp is mounted at 10 meters from the surface.*

Mounting height: 10 meters (33 feet)



Total lumen output:

1486 lm

Peak candela output:

576 cd

PRODUCT NAME:

ECLPANEL TWCJR

MEASUREMENT CONDITIONS:

Beam angle:

Filter LD

Target:

Blue

Operator:

Paolo Carvone

Date and time:

14/05/2020 15:43:00

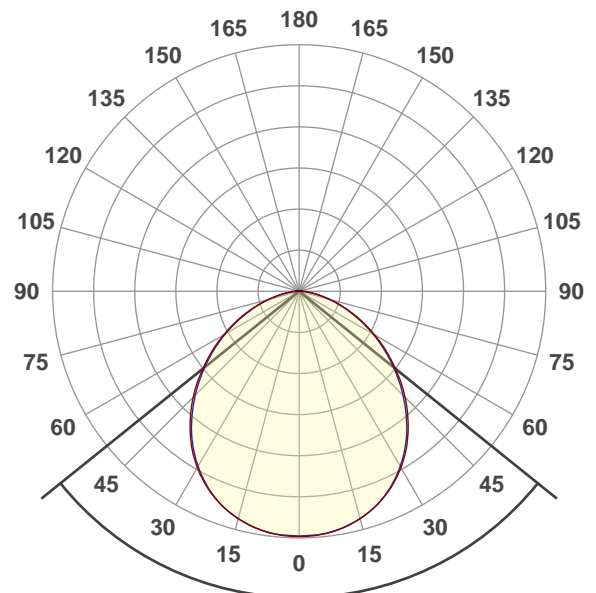

Beam angle 50%: 102,4°

Field angle 10%: 155°

Cut off angle 2.5%: 175,2°

Spectra

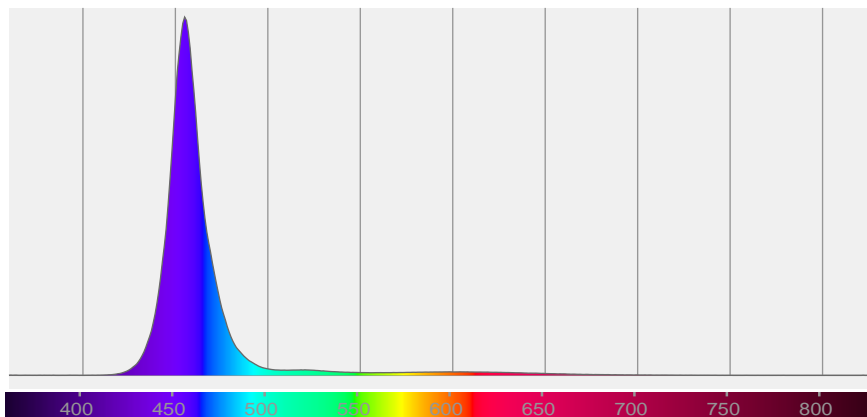

# BEAM DETAILS



Beam angle 50%	Field angle 10%	Cut off angle 2,5%	Intensity ratio in 120° cone	Intensity ratio in 90° cone
102,4°	155°	175,2°	81,5%	57,6%

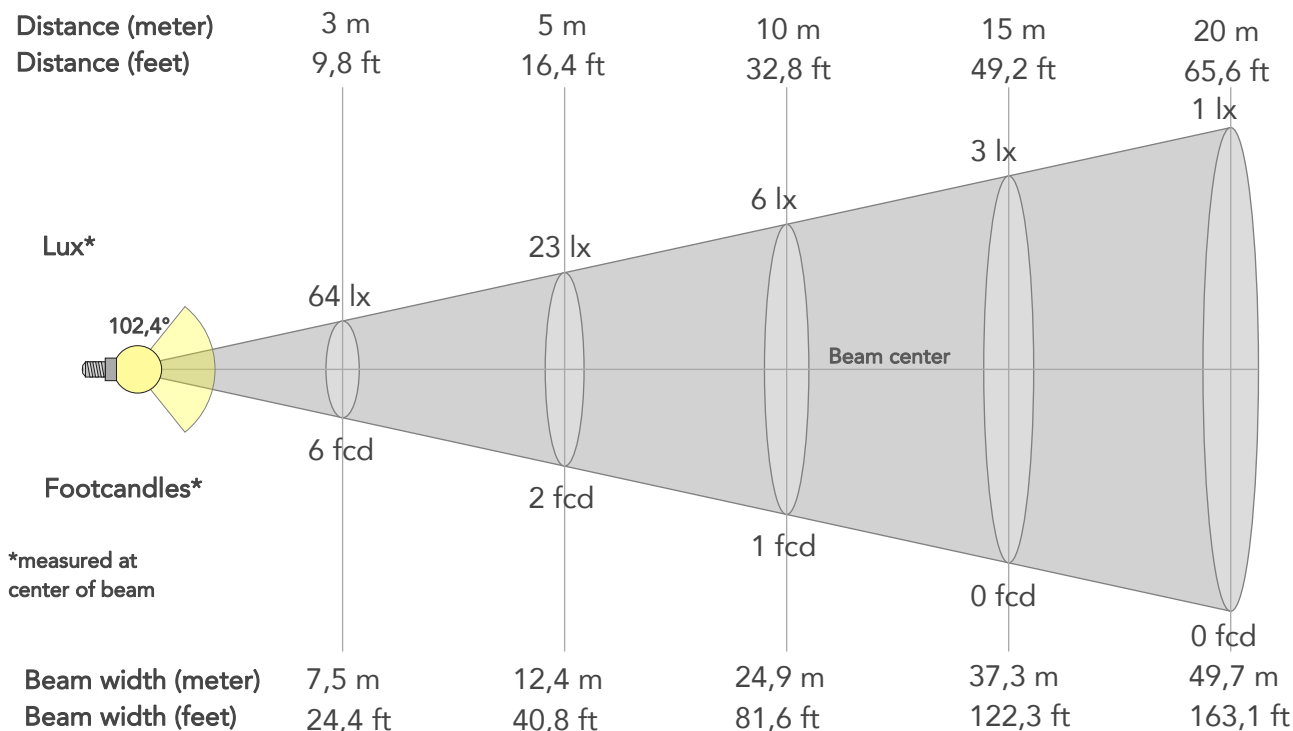

## BEAM INTENSITIES AND WIDTHS

Distance	1m	2m	3m	4m	5m	7,5m	10m	15m	20m	25m	30m	40m	50m
Distance	3,3ft	6,6ft	9,8ft	13,1ft	16,4ft	24,6ft	32,8ft	49,2ft	65,6ft	82ft	98,4ft	131,2ft	164ft
Lux	575lx	144lx	64lx	36lx	23lx	10lx	6lx	3lx	1lx	1lx	1lx	0lx	0lx
Footcand.	53fcd	13fcd	6fcd	3fcd	2fcd	1fcd	1fcd	0fcd	0fcd	0fcd	0fcd	0fcd	0fcd
Beam wid.	2,5m	5m	7,5m	9,9m	12,4m	18,6m	24,9m	37,3m	49,7m	62,2m	74,6m	99,5m	124,3m
Beam wid.	8,2ft	16,4ft	24,4ft	32,6ft	40,8ft	61,2ft	81,6ft	122,3ft	163,1ft	203,9ft	244,7ft	326,2ft	407,8ft

## LINEAR DISTRIBUTION DIAGRAM

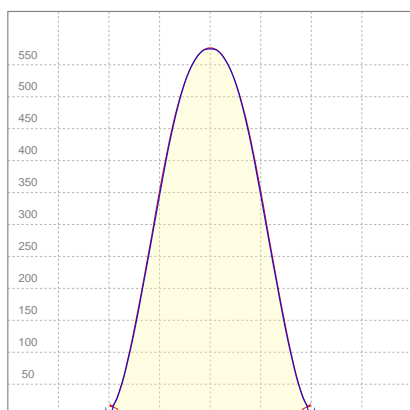

## ELECTRICAL SPECIFICATIONS

Input voltage	Input current	Input power	Effeciency
226V	0,346A	67,0W	22lm/W



## ISO CANDELA DIAGRAM

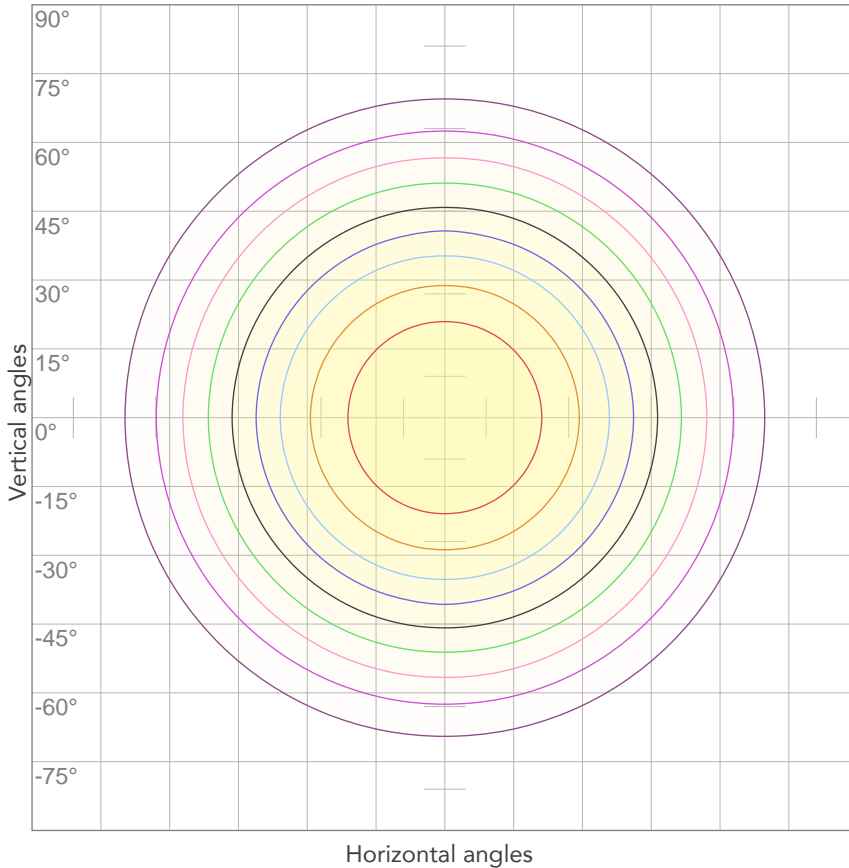

10%	58 cd
20%	115 cd
30%	173 cd
40%	230 cd
50%	288 cd
60%	345 cd
70%	403 cd
80%	460 cd

Conditions:

Number of c-planes: 4

Candela at center: 575 cd

## ISO LUX DIAGRAM

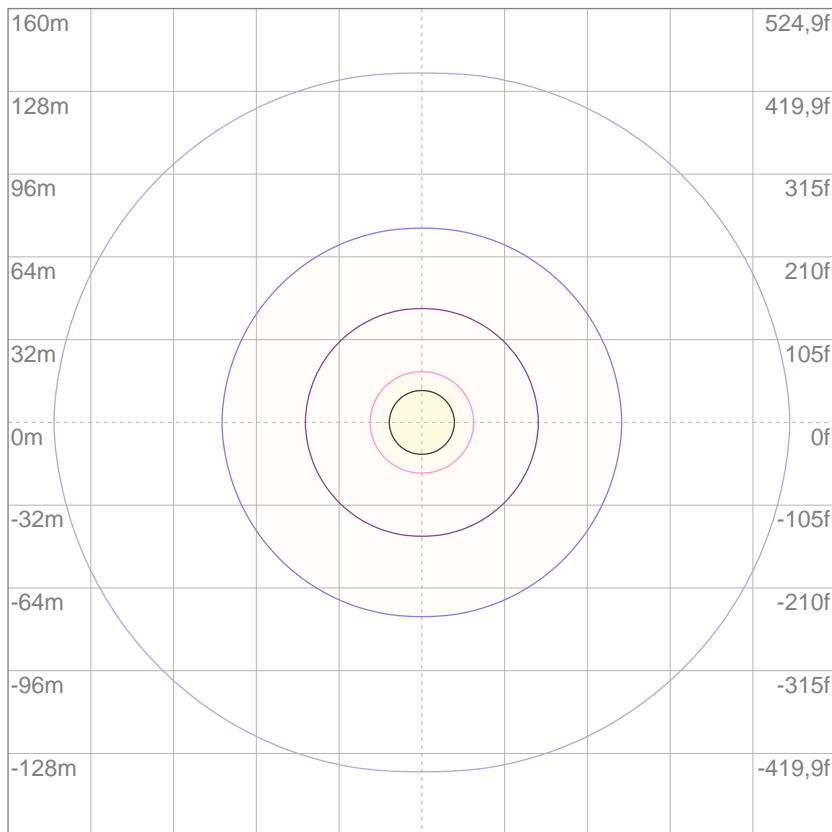

3%	0,173 lx
5%	0,288 lx
10%	0,575 lx
30%	1,73 lx
50%	2,88 lx

Conditions:

Number of c-planes: 4

Lux at center: 5,75 lx

*Lux distribution on a surface when lamp is mounted at 10 meters from the surface.*

Mounting height: 10 meters (33 feet)



Total lumen output:

1155 lm

Peak candela output:

794 cd

**PRODUCT NAME:**

ECLPANEL TWCJR

**MEASUREMENT CONDITIONS:**

Beam angle:

Filter INT

Target:

Blue

Operator:

Paolo Carvone

Date and time:

13/11/2020 11:55:51

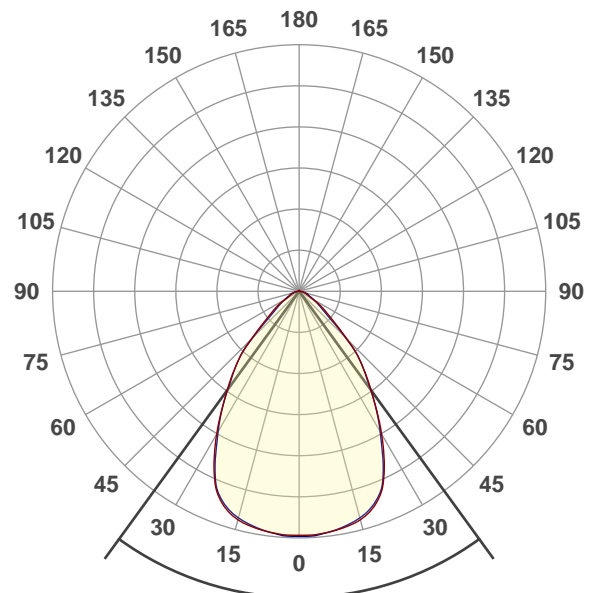

Beam angle 50%: 72°

Field angle 10%: 111,4°

Cut off angle 2.5%: 148,5°

Spectra

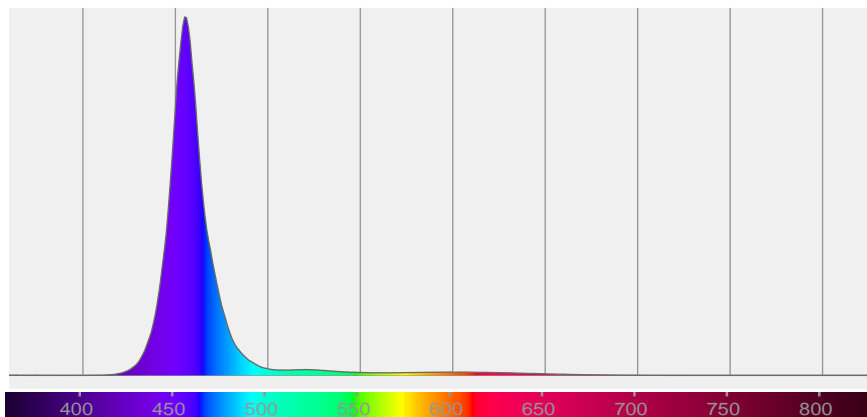

# BEAM DETAILS



Beam angle 50%	Field angle 10%	Cut off angle 2,5%	Intensity ratio in 120° cone	Intensity ratio in 90° cone
72°	111,4°	148,5°	94,3%	81,9%

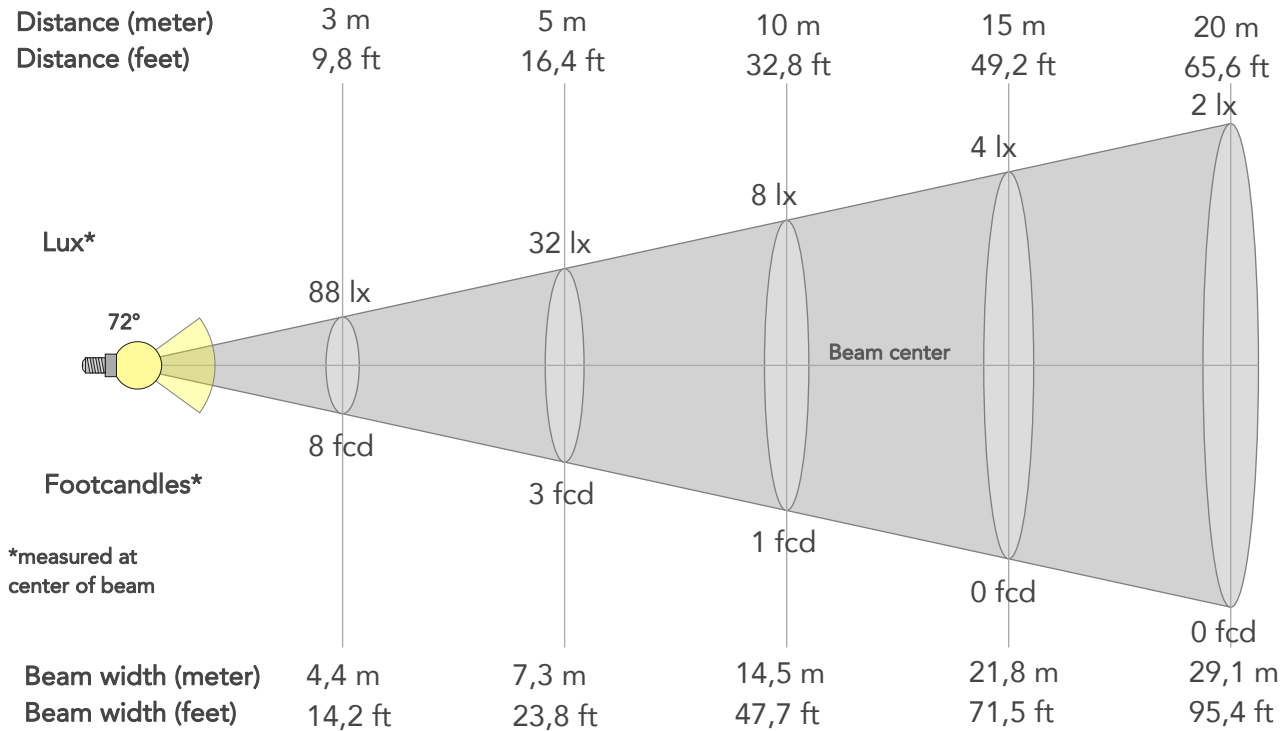

## BEAM INTENSITIES AND WIDTHS

Distance	1m	2m	3m	4m	5m	7,5m	10m	15m	20m	25m	30m	40m	50m
Distance	3,3ft	6,6ft	9,8ft	13,1ft	16,4ft	24,6ft	32,8ft	49,2ft	65,6ft	82ft	98,4ft	131,2ft	164ft
Lux	793lx	198lx	88lx	50lx	32lx	14lx	8lx	4lx	2lx	1lx	1lx	0lx	0lx
Footcand.	74fcd	18fcd	8fcd	5fcd	3fcd	1fcd	1fcd	0fcd	0fcd	0fcd	0fcd	0fcd	0fcd
Beam wid.	1,5m	2,9m	4,4m	5,8m	7,3m	10,9m	14,5m	21,8m	29,1m	36,3m	43,6m	58,1m	72,7m
Beam wid.	4,8ft	9,6ft	14,2ft	19ft	23,8ft	35,8ft	47,7ft	71,5ft	95,4ft	119,2ft	143ft	190,7ft	238,4ft

## LINEAR DISTRIBUTION DIAGRAM

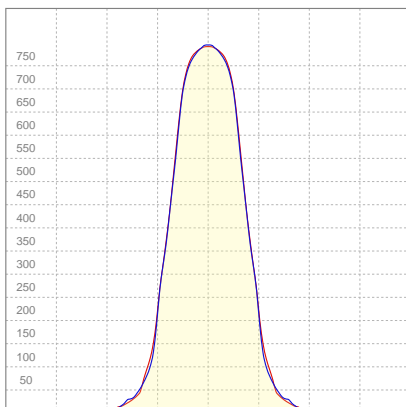

## ELECTRICAL SPECIFICATIONS

Input voltage	Input current	Input power	Effeciency
226V	0,404A	65,7W	18lm/W

Power FC
0,72

## ISO CANDELA DIAGRAM

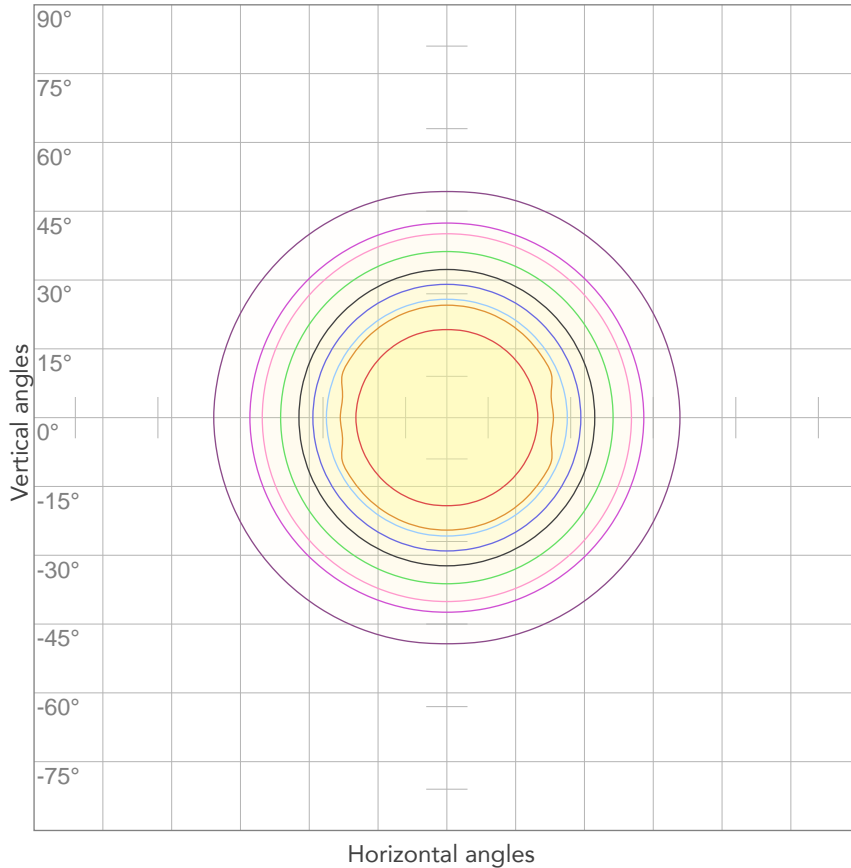

10%	79 cd
20%	159 cd
30%	238 cd
40%	317 cd
50%	396 cd
60%	476 cd
70%	555 cd
80%	634 cd

**Conditions:**

Number of c-planes: 4

Candela at center: 793 cd

## ISO LUX DIAGRAM

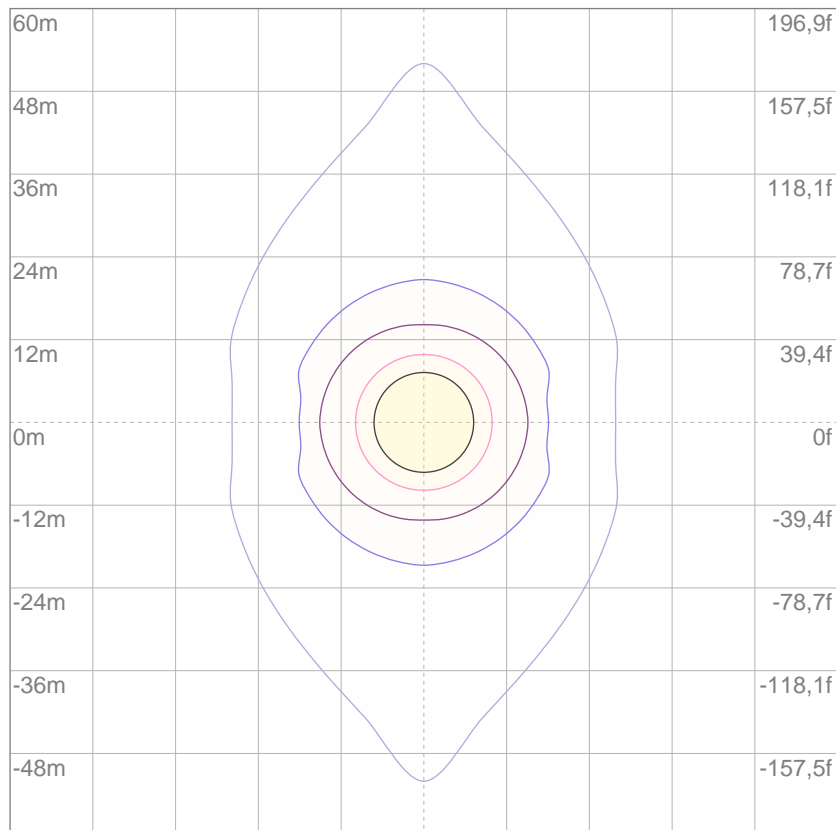

Mounting height: 10 meters (33 feet)

3%	0,238 lx
5%	0,396 lx
10%	0,793 lx
30%	2,38 lx
50%	3,96 lx

**Conditions:**

Number of c-planes: 4

Lux at center: 7,93 lx

*Lux distribution on a surface when lamp is mounted at 10 meters from the surface.*



Total lumen output:

14306 lm

Peak candela output:

4934 cd

**PRODUCT NAME:**

ECLPANEL TWCJR

**MEASUREMENT CONDITIONS:**

Beam angle:

Filter HD

Target:

White

Operator:

Paolo Carvone

Date and time:

14/05/2020 16:19:36

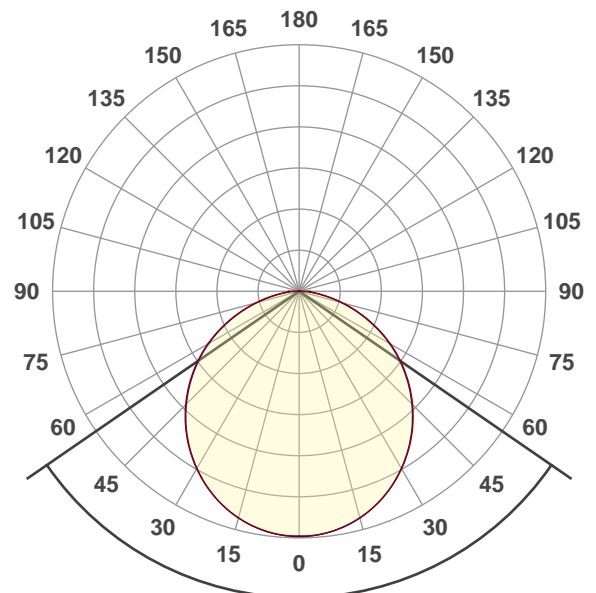

Beam angle 50%: 110,9°

Field angle 10%: 161,3°

Cut off angle 2.5%: 177°

Spectra

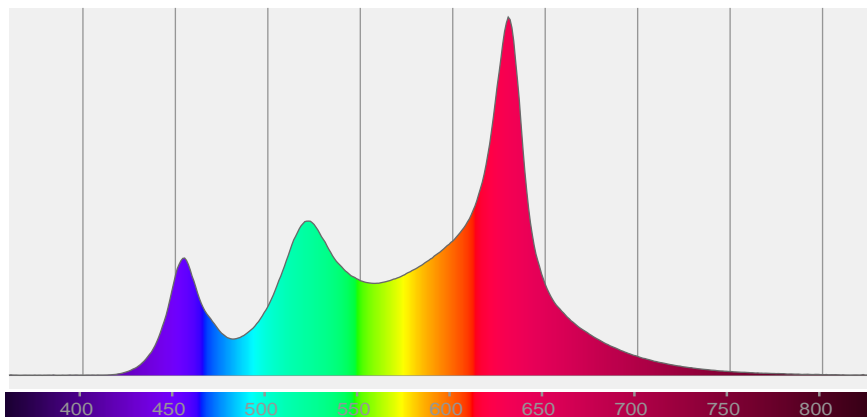

# BEAM DETAILS



Beam angle 50%	Field angle 10%	Cut off angle 2,5%	Intensity ratio in 120° cone	Intensity ratio in 90° cone
110,9°	161,3°	177°	76,4%	52,2%

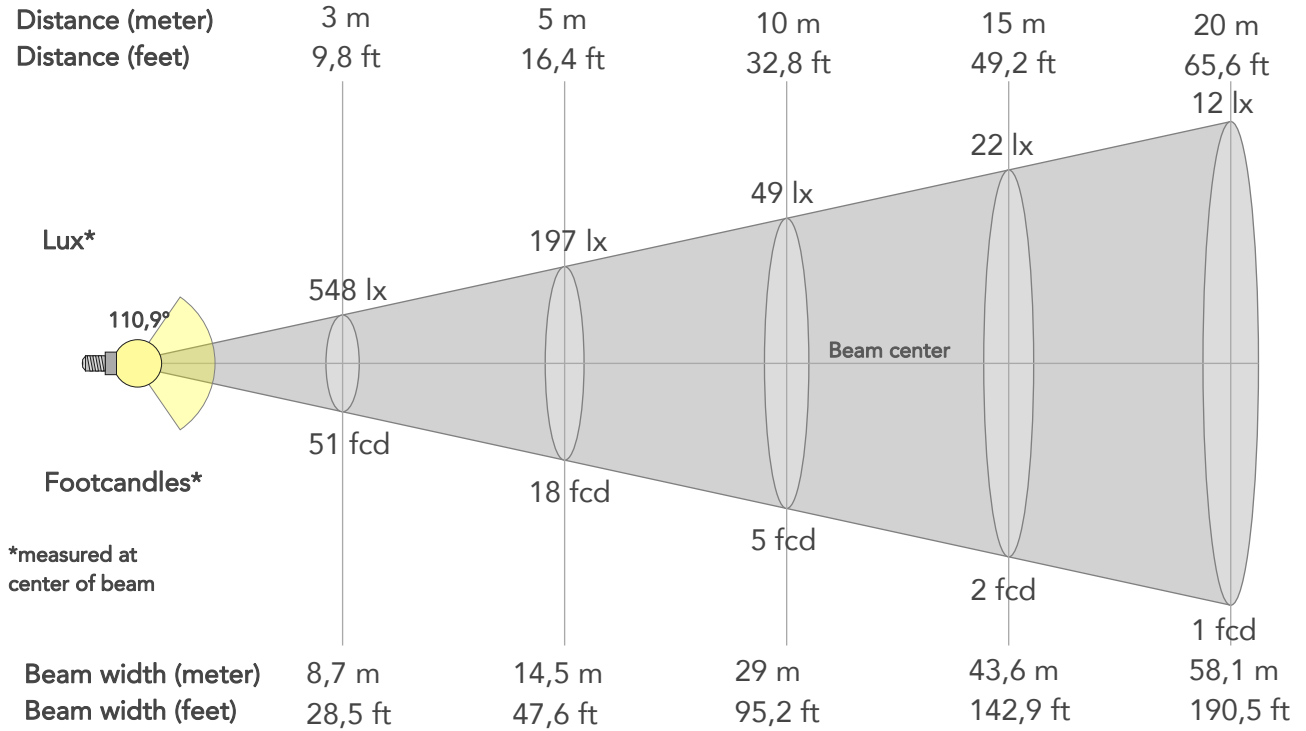

## BEAM INTENSITIES AND WIDTHS

Distance	1m	2m	3m	4m	5m	7,5m	10m	15m	20m	25m	30m	40m	50m
Distance	3,3ft	6,6ft	9,8ft	13,1ft	16,4ft	24,6ft	32,8ft	49,2ft	65,6ft	82ft	98,4ft	131,2ft	164ft
Lux	4929lx	1232lx	548lx	308lx	197lx	88lx	49lx	22lx	12lx	8lx	5lx	3lx	2lx
Footcand.	458fcd	114fcd	51fcd	29fcd	18fcd	8fcd	5fcd	2fcd	1fcd	1fcd	1fcd	0fcd	0fcd
Beam wid.	2,9m	5,8m	8,7m	11,6m	14,5m	21,8m	29m	43,6m	58,1m	72,6m	87,1m	116,2m	145,2m
Beam wid.	9,6ft	19,2ft	28,5ft	38ft	47,6ft	71,4ft	95,2ft	142,9ft	190,5ft	238,1ft	285,7ft	381ft	476,2ft

## LINEAR DISTRIBUTION DIAGRAM

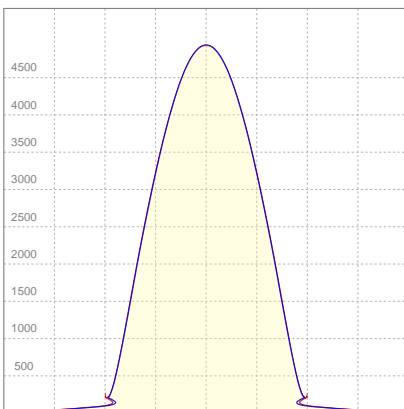

## ELECTRICAL SPECIFICATIONS

Input voltage	Input current	Input power	Effeciency
225V	1,03A	227,7W	63lm/W

## ISO CANDELA DIAGRAM

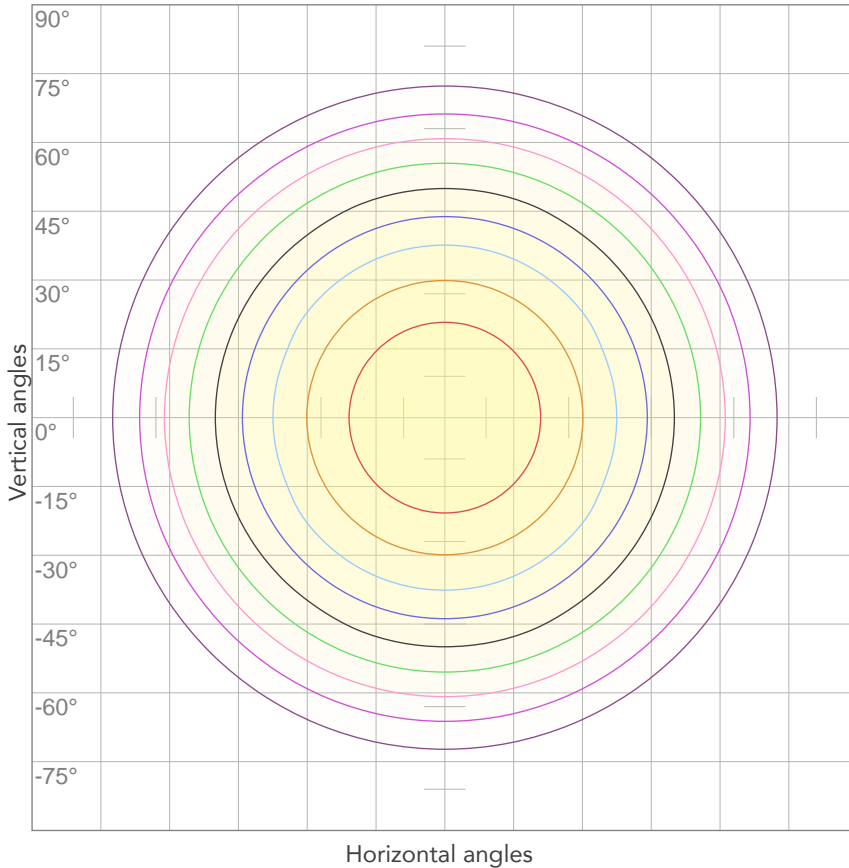

10%	493 cd
20%	986 cd
30%	1479 cd
40%	1972 cd
50%	2465 cd
60%	2958 cd
70%	3451 cd
80%	3944 cd

Conditions:

Number of c-planes: 4

Candela at center: 4929 cd

## ISO LUX DIAGRAM

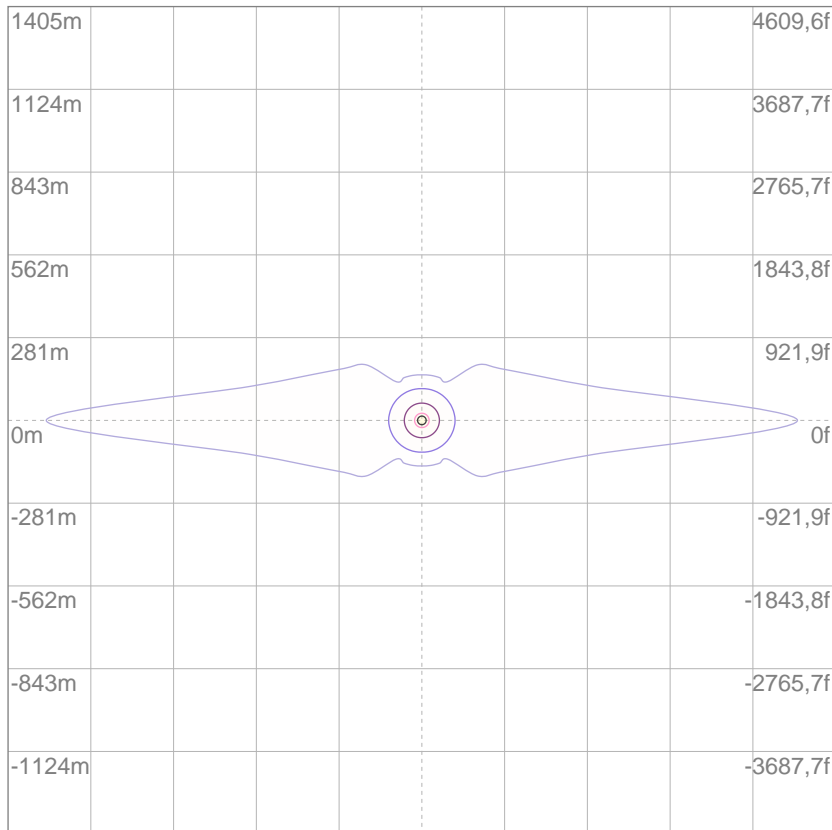

3%	1,48 lx
5%	2,46 lx
10%	4,93 lx
30%	14,8 lx
50%	24,6 lx

Conditions:

Number of c-planes: 4

Lux at center: 49,3 lx

*Lux distribution on a surface when lamp is mounted at 10 meters from the surface.*

Mounting height: 10 meters (33 feet)



Total lumen output:

16647 lm

Peak candela output:

6404 cd

**PRODUCT NAME:**

ECLPANEL TWCJR

**MEASUREMENT CONDITIONS:**

Beam angle:

Filter MD

Target:

White

Operator:

Paolo Carvone

Date and time:

14/05/2020 16:01:49

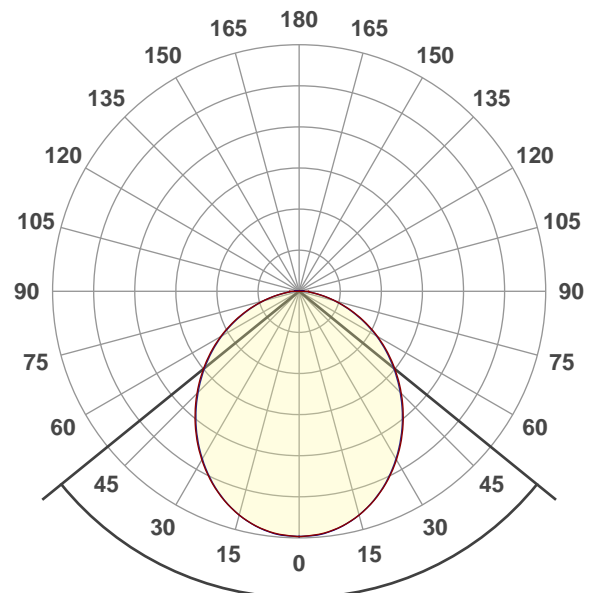

Beam angle 50%: 101,9°

Field angle 10%: 158,3°

Cut off angle 2.5%: 177,3°

Spectra

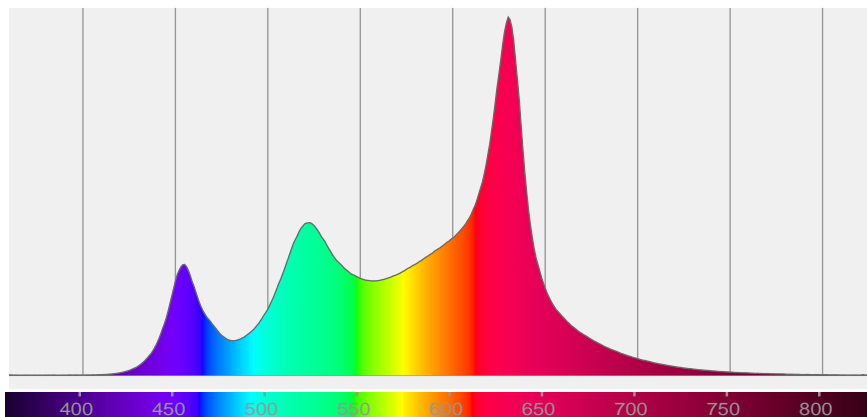



# BEAM DETAILS



Beam angle 50%	Field angle 10%	Cut off angle 2,5%	Intensity ratio in 120° cone	Intensity ratio in 90° cone
101,9°	158,3°	177,3°	78,9%	55,3%

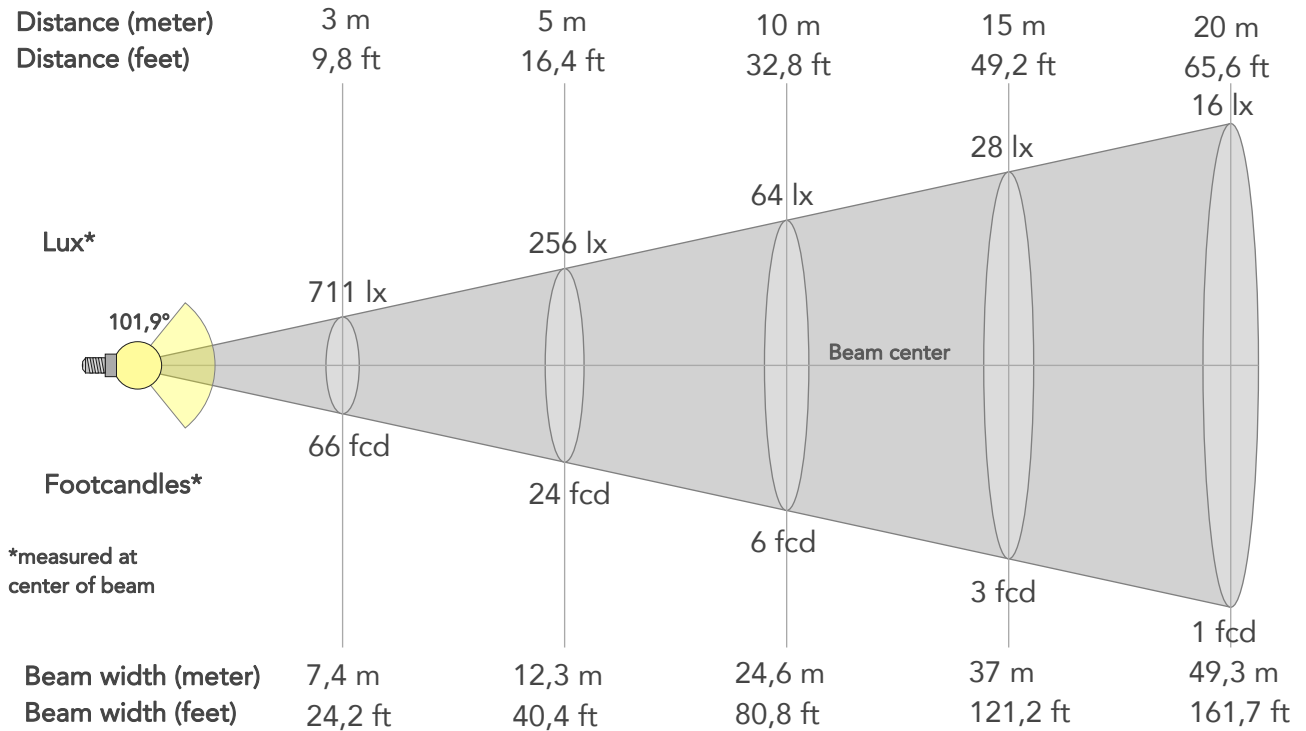

## BEAM INTENSITIES AND WIDTHS

Distance	1m	2m	3m	4m	5m	7,5m	10m	15m	20m	25m	30m	40m	50m
Distance	3,3ft	6,6ft	9,8ft	13,1ft	16,4ft	24,6ft	32,8ft	49,2ft	65,6ft	82ft	98,4ft	131,2ft	164ft
Lux	6403lx	1601lx	711lx	400lx	256lx	114lx	64lx	28lx	16lx	10lx	7lx	4lx	3lx
Footcand.	595fcd	149fcd	66fcd	37fcd	24fcd	11fcd	6fcd	3fcd	1fcd	1fcd	1fcd	0fcd	0fcd
Beam wid.	2,5m	4,9m	7,4m	9,9m	12,3m	18,5m	24,6m	37m	49,3m	61,6m	73,9m	98,6m	123,2m
Beam wid.	8,1ft	16,3ft	24,2ft	32,3ft	40,4ft	60,6ft	80,8ft	121,2ft	161,7ft	202,1ft	242,5ft	323,3ft	404,2ft

## LINEAR DISTRIBUTION DIAGRAM

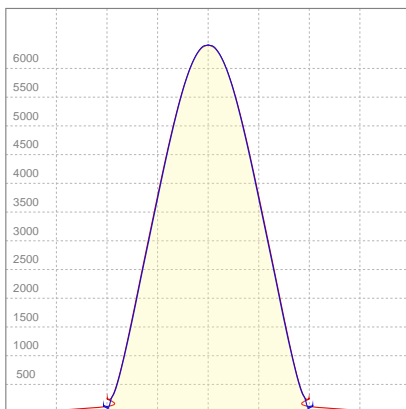

## ELECTRICAL SPECIFICATIONS

Input voltage	Input current	Input power	Effeciency
225V	1,03A	227,7W	73lm/W

## ISO CANDELA DIAGRAM

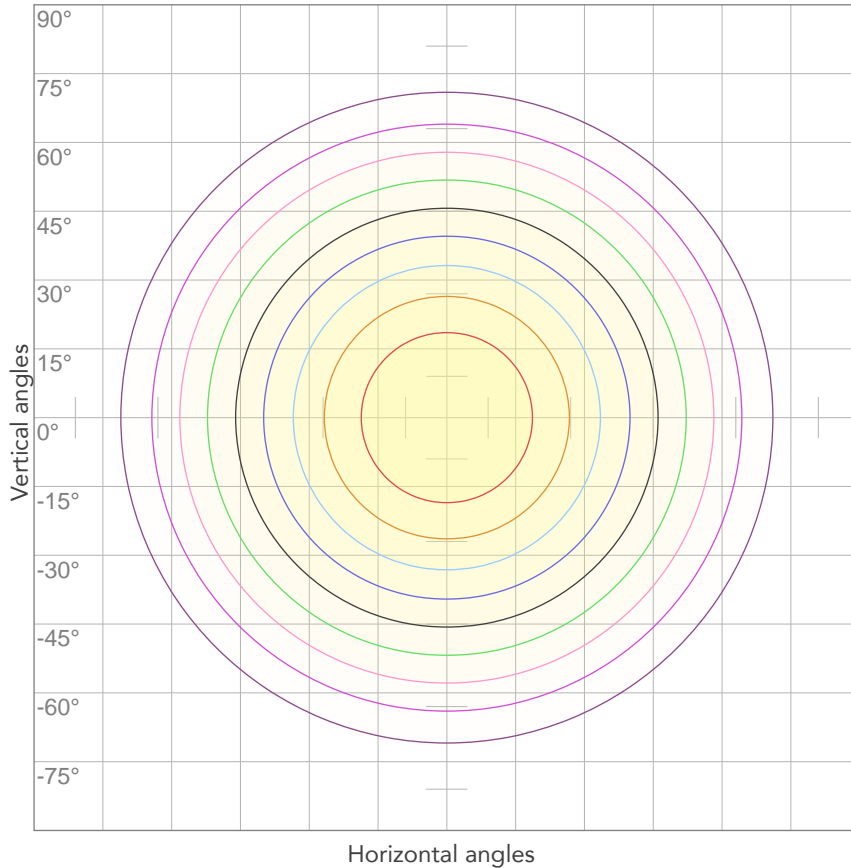

10%	640 cd
20%	1281 cd
30%	1921 cd
40%	2561 cd
50%	3202 cd
60%	3842 cd
70%	4482 cd
80%	5122 cd

Conditions:

Number of c-planes: 4

Candela at center: 6403 cd

## ISO LUX DIAGRAM

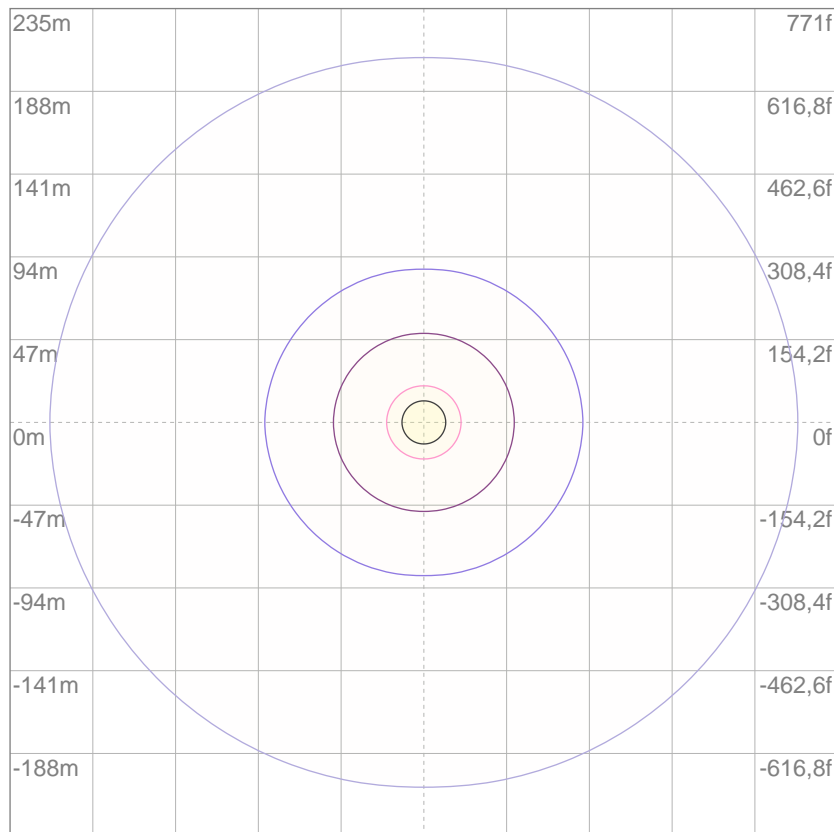

Mounting height: 10 meters (33 feet)

3%	1,92 lx
5%	3,20 lx
10%	6,40 lx
30%	19,2 lx
50%	32,0 lx

Conditions:

Number of c-planes: 4

Lux at center: 64,0 lx

*Lux distribution on a surface when lamp is mounted at 10 meters from the surface.*



Total lumen output:

16998 lm

Peak candela output:

6588 cd

**PRODUCT NAME:**

ECLPANEL TWCJR

**MEASUREMENT CONDITIONS:**

Beam angle:

Filter LD

Target:

White

Operator:

Paolo Carvone

Date and time:

14/05/2020 15:45:03

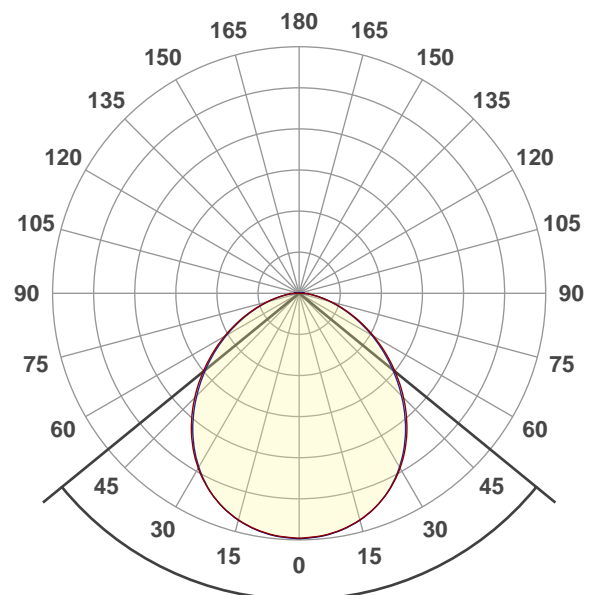

Beam angle 50%: 101,5°

Field angle 10%: 155,9°

Cut off angle 2.5%: 175,2°

Spectra

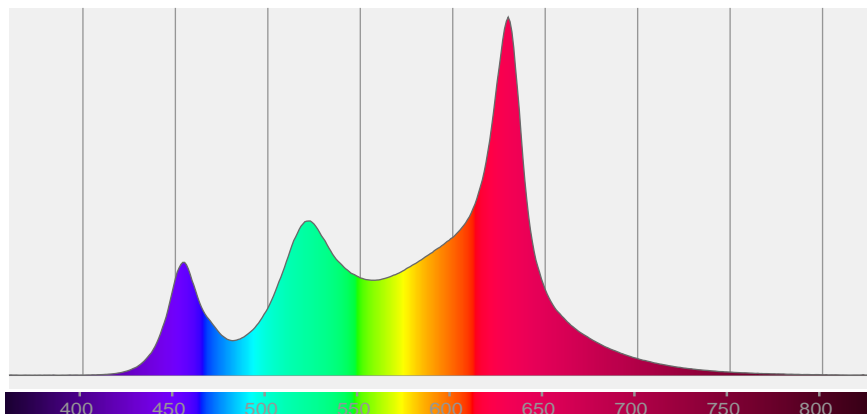

# BEAM DETAILS



Beam angle 50%	Field angle 10%	Cut off angle 2,5%	Intensity ratio in 120° cone	Intensity ratio in 90° cone
101,5°	155,9°	175,2°	80,7%	57,2%

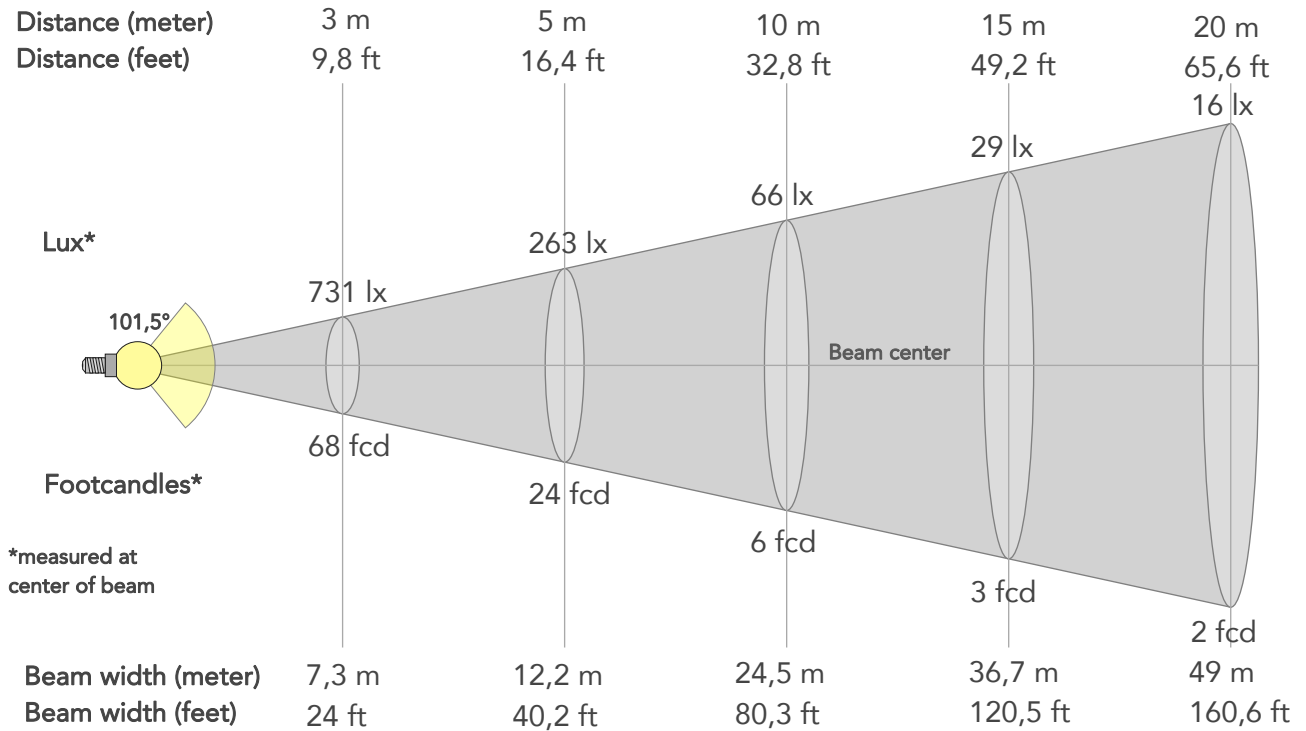

## BEAM INTENSITIES AND WIDTHS

Distance	1m	2m	3m	4m	5m	7,5m	10m	15m	20m	25m	30m	40m	50m
Distance	3,3ft	6,6ft	9,8ft	13,1ft	16,4ft	24,6ft	32,8ft	49,2ft	65,6ft	82ft	98,4ft	131,2ft	164ft
Lux	6582lx	1646lx	731lx	411lx	263lx	117lx	66lx	29lx	16lx	11lx	7lx	4lx	3lx
Footcand.	612fcd	153fcd	68fcd	38fcd	24fcd	11fcd	6fcd	3fcd	2fcd	1fcd	1fcd	0fcd	0fcd
Beam wid.	2,4m	4,9m	7,3m	9,8m	12,2m	18,4m	24,5m	36,7m	49m	61,2m	73,5m	98m	122,4m
Beam wid.	8,1ft	16,2ft	24ft	32,1ft	40,2ft	60,2ft	80,3ft	120,5ft	160,6ft	200,8ft	241ft	321,3ft	401,6ft

## LINEAR DISTRIBUTION DIAGRAM

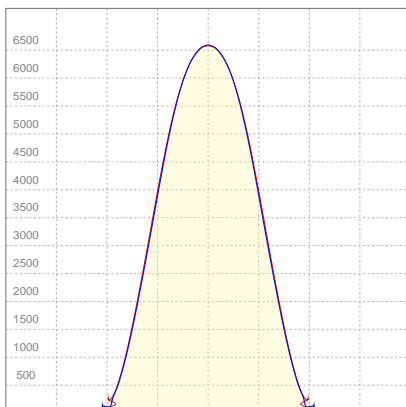

## ELECTRICAL SPECIFICATIONS

Input voltage	Input current	Input power	Effeciency
225V	1,03A	228,7W	74lm/W

## ISO CANDELA DIAGRAM

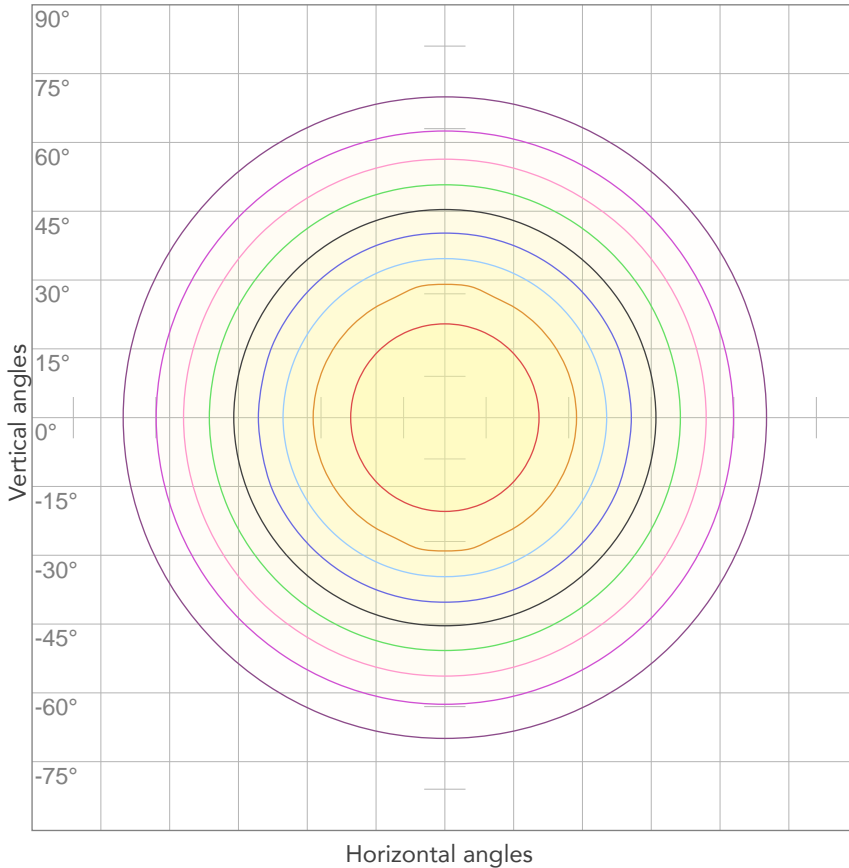

10%	658 cd
20%	1316 cd
30%	1975 cd
40%	2633 cd
50%	3291 cd
60%	3949 cd
70%	4608 cd
80%	5266 cd

Conditions:

Number of c-planes: 4

Candela at center: 6582 cd

## ISO LUX DIAGRAM

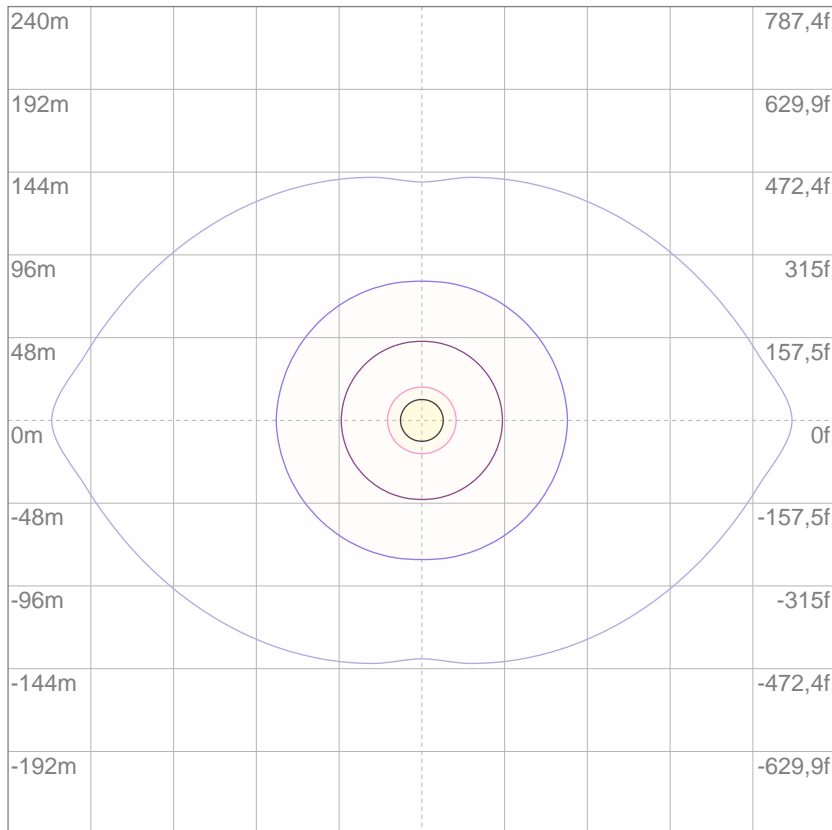

3%	1,97 lx
5%	3,29 lx
10%	6,58 lx
30%	19,7 lx
50%	32,9 lx

Conditions:

Number of c-planes: 4

Lux at center: 65,8 lx

*Lux distribution on a surface when lamp is mounted at 10 meters from the surface.*

Mounting height: 10 meters (33 feet)



Total lumen output:

13875 lm

Peak candela output:

9127 cd

**PRODUCT NAME:**

ECLPANEL TWCJR

**MEASUREMENT CONDITIONS:**

Beam angle:

Filter INT

Target:

White

Operator:

Paolo Carvone

Date and time:

13/11/2020 11:58:58

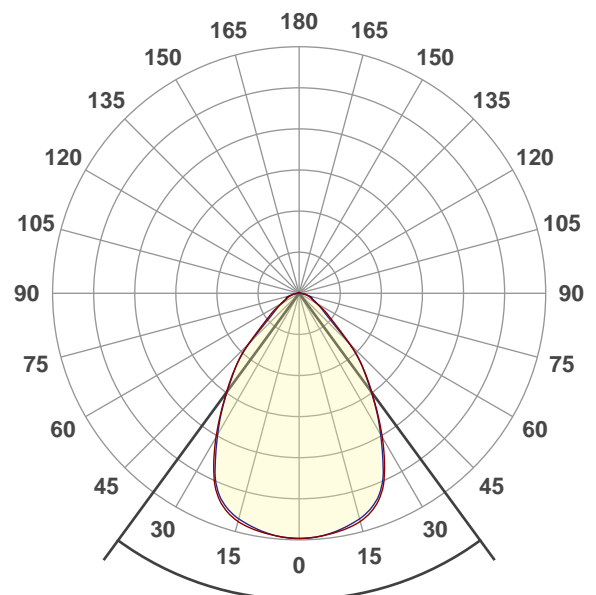

Beam angle 50%: 72,5°

Field angle 10%: 115,3°

Cut off angle 2.5%: 160,7°

Spectra

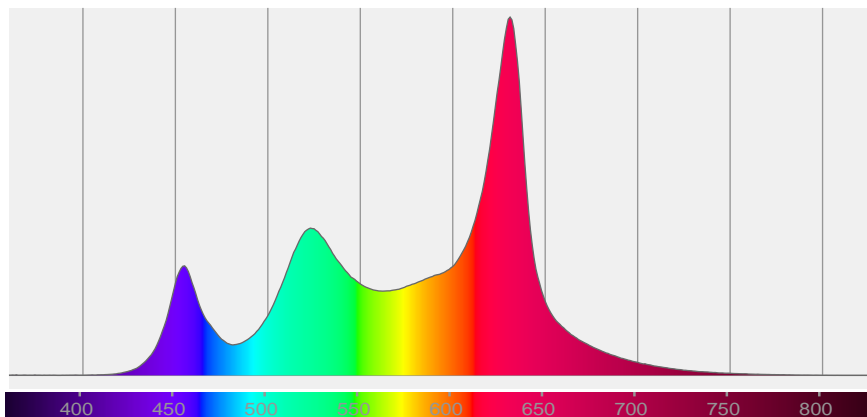

# BEAM DETAILS



Beam angle 50%	Field angle 10%	Cut off angle 2,5%	Intensity ratio in 120° cone	Intensity ratio in 90° cone
72,5°	115,3°	160,7°	92,0%	78,8%

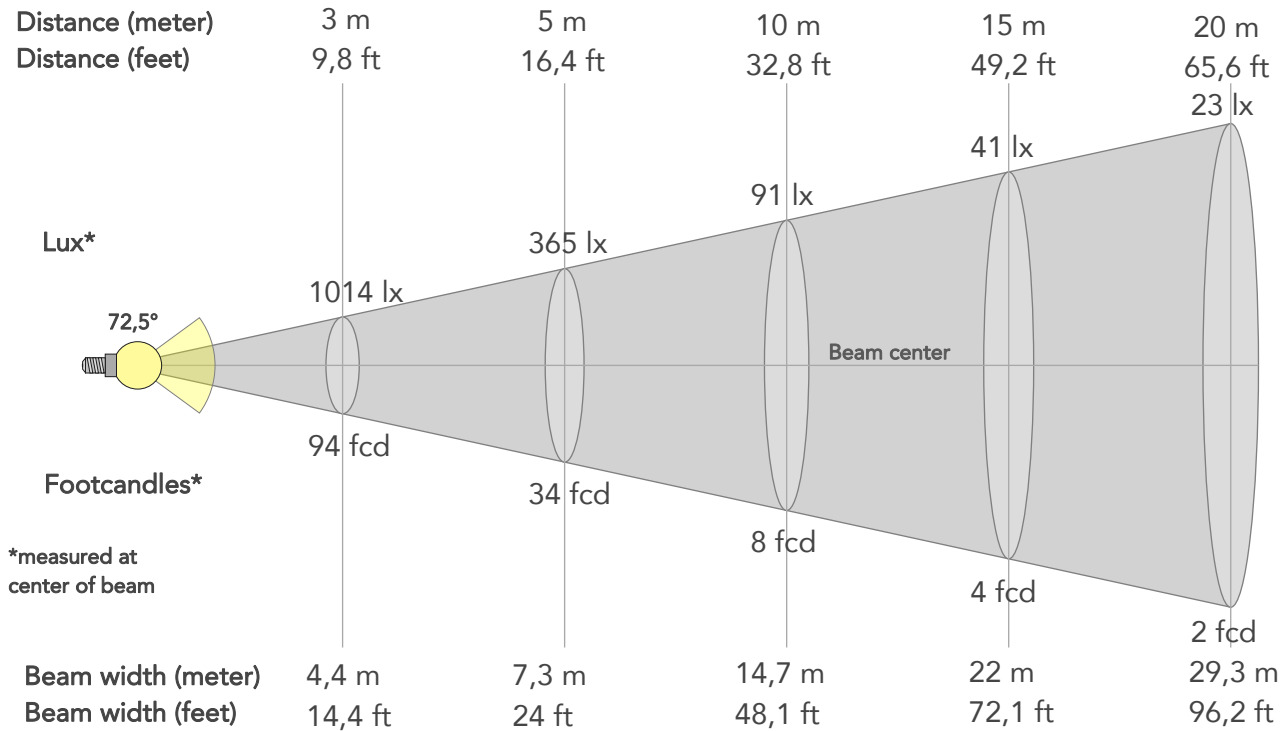

## BEAM INTENSITIES AND WIDTHS

Distance	1m	2m	3m	4m	5m	7,5m	10m	15m	20m	25m	30m	40m	50m
Distance	3,3ft	6,6ft	9,8ft	13,1ft	16,4ft	24,6ft	32,8ft	49,2ft	65,6ft	82ft	98,4ft	131,2ft	164ft
Lux	9126lx	2281lx	1014lx	570lx	365lx	162lx	91lx	41lx	23lx	15lx	10lx	6lx	4lx
Footcand.	848fcd	212fcd	94fcd	53fcd	34fcd	15fcd	8fcd	4fcd	2fcd	1fcd	1fcd	1fcd	0fcd
Beam wid.	1,5m	2,9m	4,4m	5,9m	7,3m	11m	14,7m	22m	29,3m	36,6m	44m	58,6m	73,3m
Beam wid.	4,8ft	9,7ft	14,4ft	19,2ft	24ft	36,1ft	48,1ft	72,1ft	96,2ft	120,2ft	144,2ft	192,3ft	240,4ft

## LINEAR DISTRIBUTION DIAGRAM

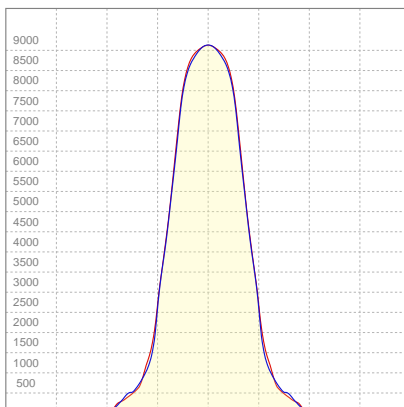

## ELECTRICAL SPECIFICATIONS

Input voltage	Input current	Input power	Effeciency
227V	1,05A	228,4W	61lm/W
Power FC			
0,96			

## ISO CANDELA DIAGRAM

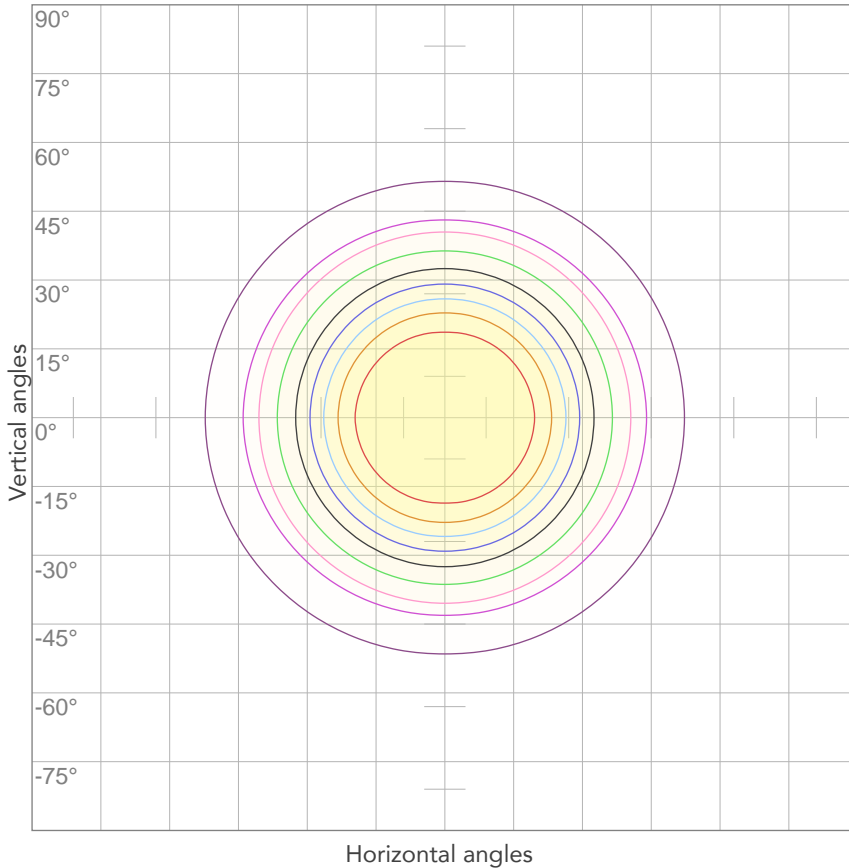

10%	913 cd
20%	1825 cd
30%	2738 cd
40%	3650 cd
50%	4563 cd
60%	5475 cd
70%	6388 cd
80%	7301 cd

Conditions:

Number of c-planes: 4

Candela at center: 9126 cd

## ISO LUX DIAGRAM

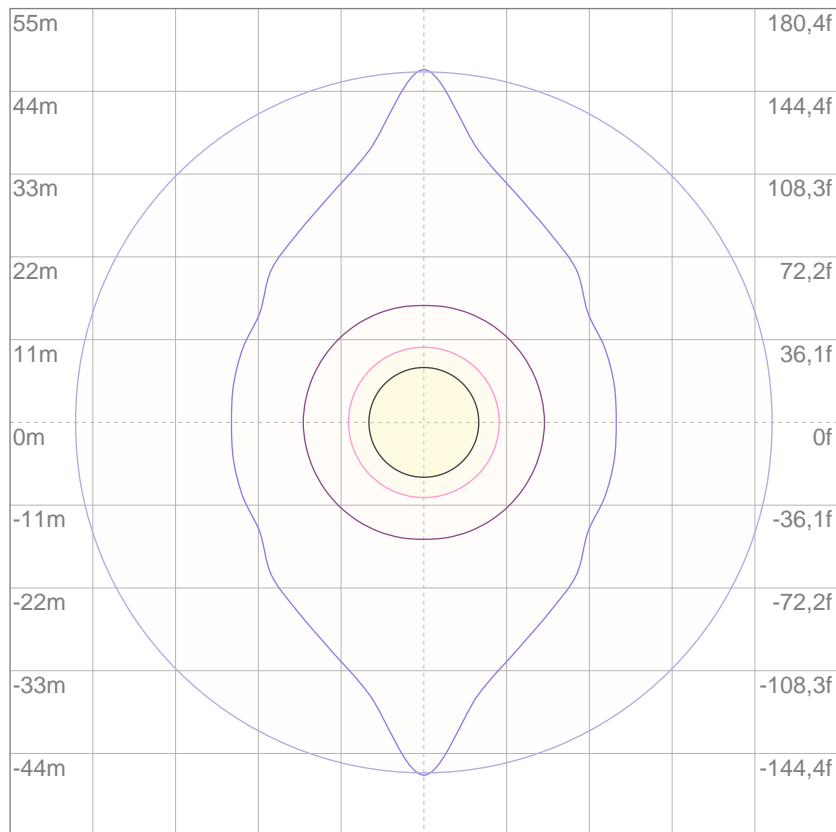

Mounting height: 10 meters (33 feet)

3%	2,74 lx
5%	4,56 lx
10%	9,13 lx
30%	27,4 lx
50%	45,6 lx

Conditions:

Number of c-planes: 4

Lux at center: 91,3 lx

*Lux distribution on a surface when lamp is mounted at 10 meters from the surface.*





Total lumen output:

14241 lm

Peak candela output:

4980 cd

Light quality:

CRI: 85,9

Color temperature:

2864 K

**PRODUCT NAME:**

ECLPANEL TWCJR

**MEASUREMENT CONDITIONS:**

Beam angle:

Filter HD

Target:

2800K

Operator:

Paolo Carvone

Date and time:

14/05/2020 16:21:16

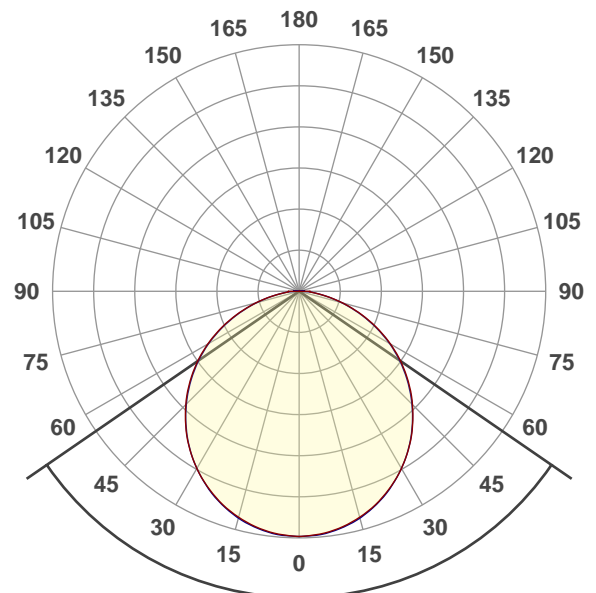

Beam angle 50%: 110,9°

Field angle 10%: 161,3°

Cut off angle 2.5%: 177,3°

Spectra

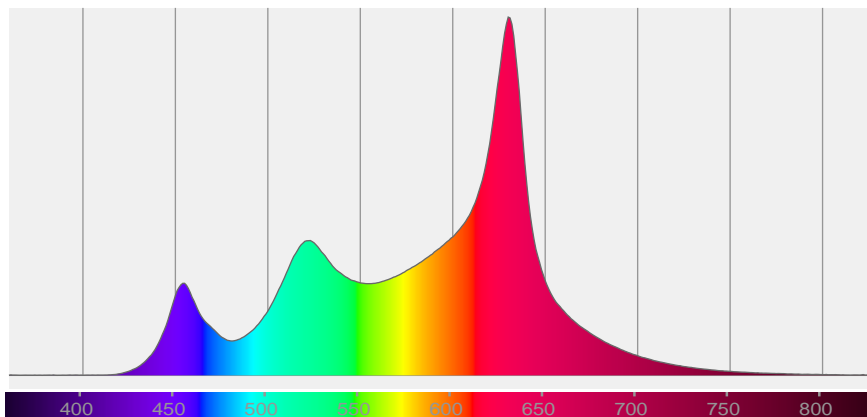

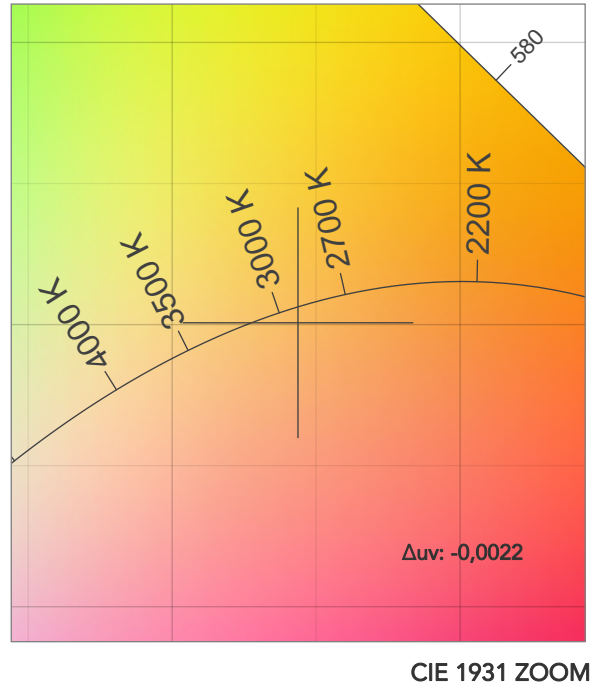
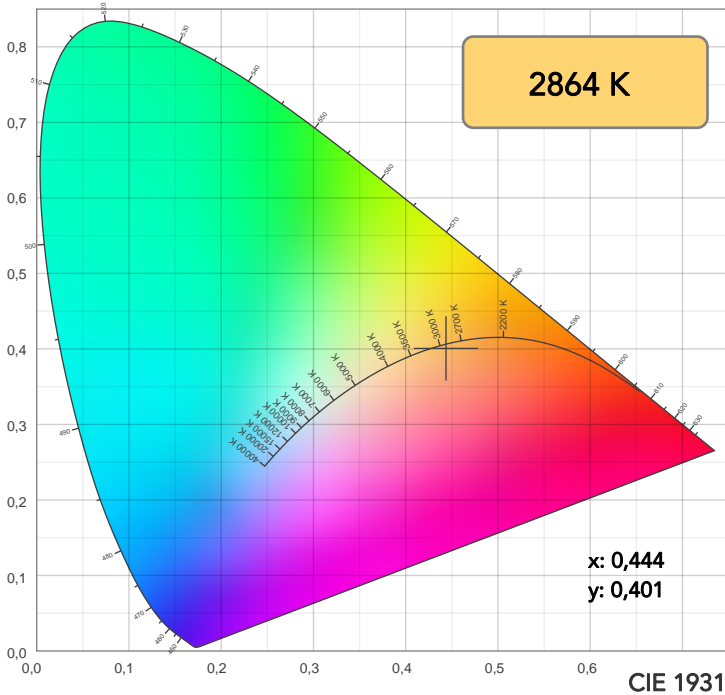

TM30: 87,5

CRI: 85,9 (R1-R8)

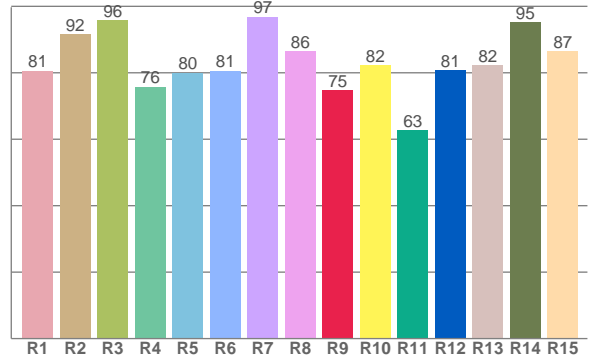
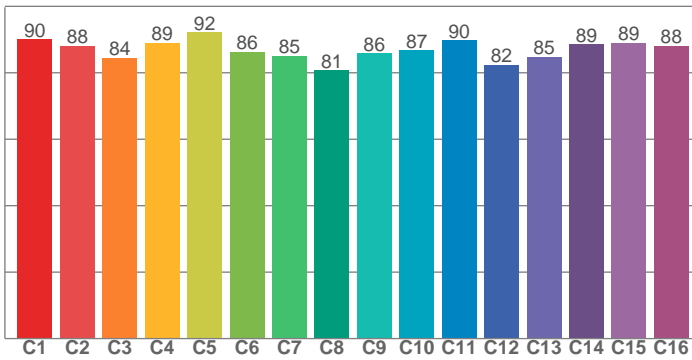

CRI R values, only R1-R8 are used to calculate final CRI value

R1	R2	R3	R4	R5	R6	R7	R8	R9	R10	R11	R12	R13	R14	R15
80,6	91,5	95,8	75,8	80,0	80,6	96,8	86,4	74,7	82,4	62,7	80,8	82,2	95,1	86,5

TM30 C values, 16 binned values out of total of 99 C values

C1	C2	C3	C4	C5	C6	C7	C8	C9	C10	C11	C12	C13	C14	C15	C16
90,1	88,0	84,4	88,9	92,2	86,3	85,0	80,7	85,8	86,7	89,7	82,4	84,8	88,6	89,0	88,2

CQS Q values

Q1	Q2	Q3	Q4	Q5	Q6	Q7	Q8	Q9	Q10	Q11	Q12	Q13	Q14	Q15
93,5	93,2	94,2	85,2	84,2	85,7	95,6	92,0	95,3	93,3	85,7	85,1	88,1	91,4	92,0

CQS: 89,3

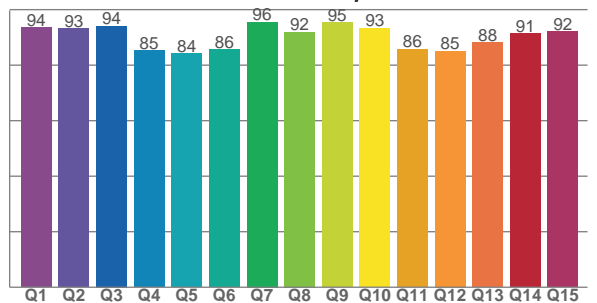

COLOR PARAMETERS

Color temperature	Color rendering index	Red component	Color fidelity	Color gamut	Color quality scale	Television lighting index	Color coordinate cie 1931	Color coordinate cie 1931	Color deviation from black body
CCT	CRI	CRI R9	TM30 Rf	TM30 Rg	CQS	TLCI	x	y	Δuv
2864 K	85,9	74,7	87,5	105,9	89,3	76	0,444	0,401	-0,0022

# TM30 DETAILS

**Rf 87,5**  
Fidelity index Rf

**Rg 105,9**  
Gammut index

Hue Bin	R <sub>f</sub>	Graphic shifts (%)	
		Chroma	Hue
1	90	3%	0%
2	88	4%	-4%
3	84	3%	-5%
4	89	-3%	-6%
5	92	-1%	2%
6	86	5%	7%
7	85	5%	6%
8	81	11%	-1%
9	86	7%	-2%
10	87	5%	-5%
11	90	4%	-5%
12	82	4%	-9%
13	85	1%	-11%
14	89	0%	-6%
15	89	0%	3%
16	88	3%	-6%

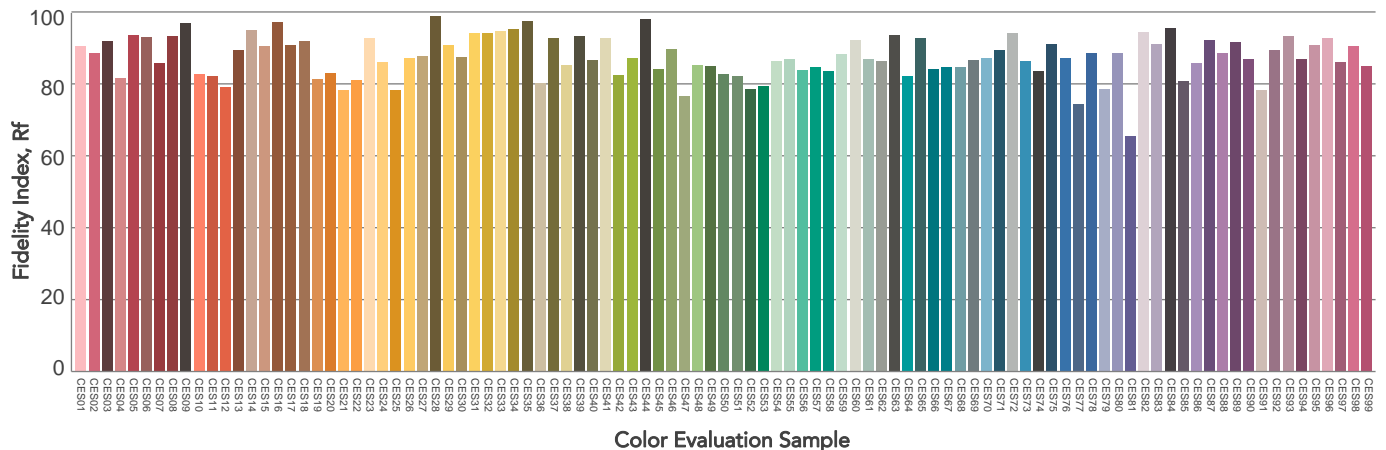
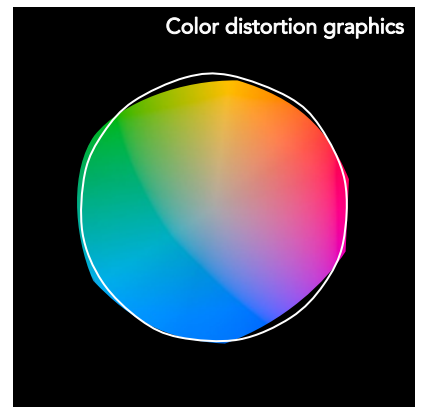
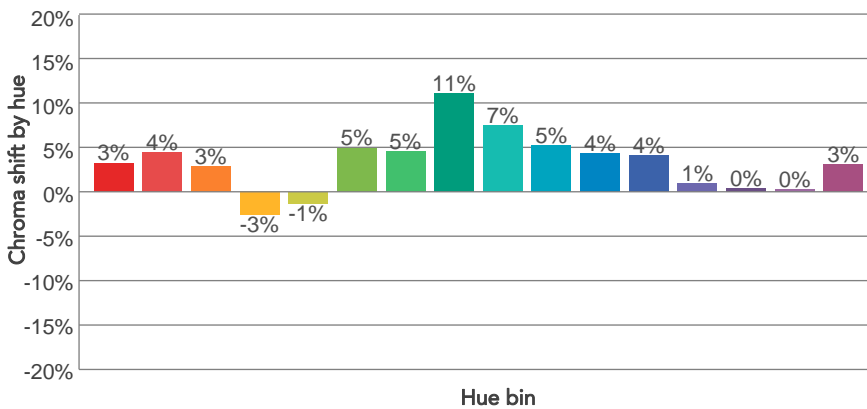
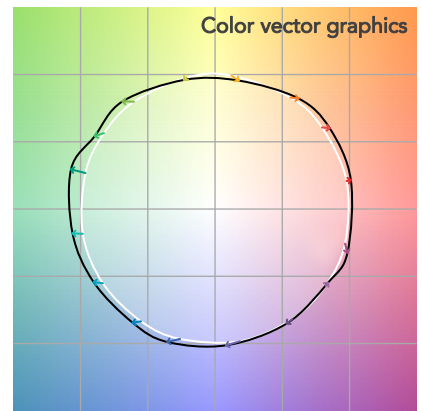
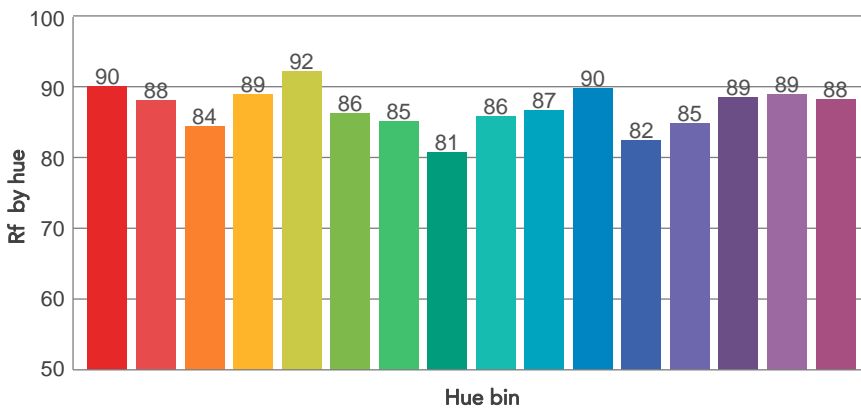
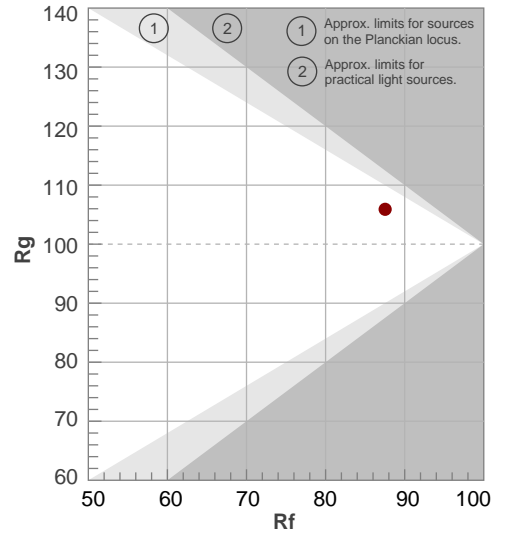

# BEAM DETAILS



Beam angle 50%	Field angle 10%	Cut off angle 2,5%	Intensity ratio in 120° cone	Intensity ratio in 90° cone
110,9°	161,3°	177,3°	77,4%	52,9%

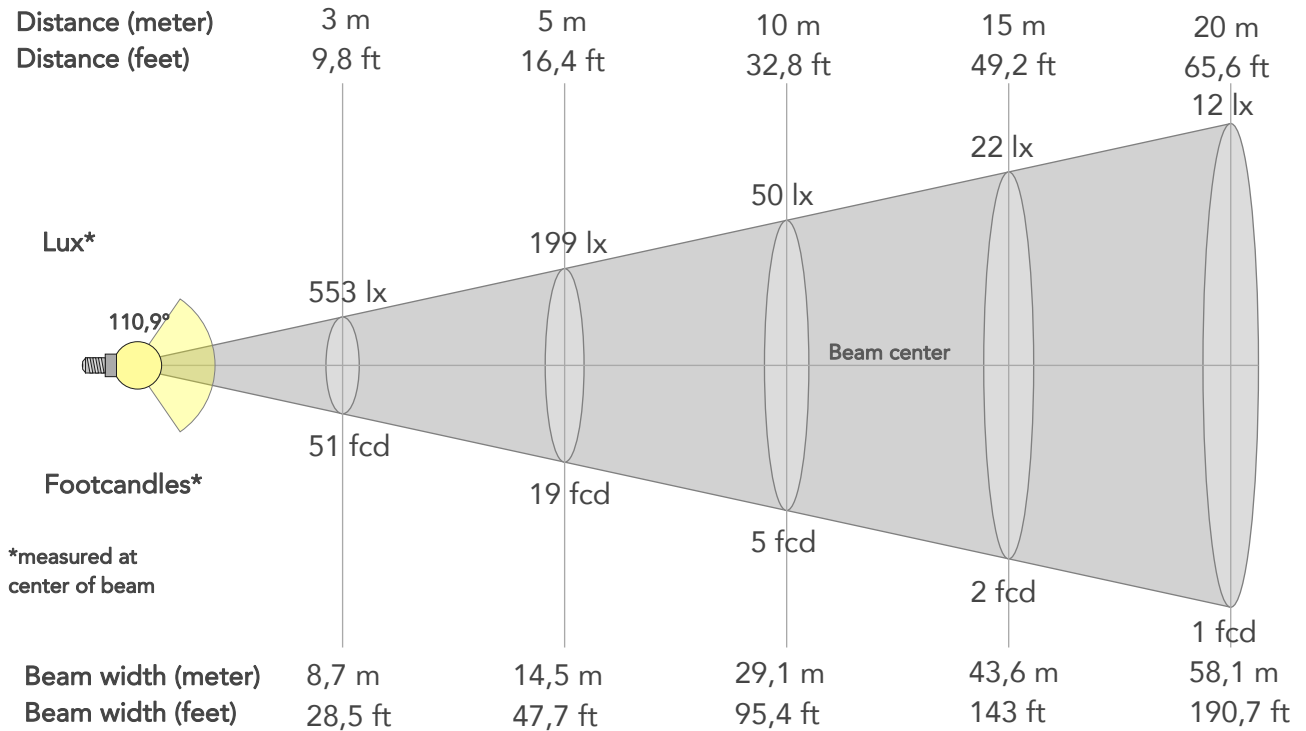

## BEAM INTENSITIES AND WIDTHS

Distance	1m	2m	3m	4m	5m	7,5m	10m	15m	20m	25m	30m	40m	50m
Distance	3,3ft	6,6ft	9,8ft	13,1ft	16,4ft	24,6ft	32,8ft	49,2ft	65,6ft	82ft	98,4ft	131,2ft	164ft
Lux	4978lx	1245lx	553lx	311lx	199lx	89lx	50lx	22lx	12lx	8lx	6lx	3lx	2lx
Footcand.	463fcd	116fcd	51fcd	29fcd	19fcd	8fcd	5fcd	2fcd	1fcd	1fcd	1fcd	0fcd	0fcd
Beam wid.	2,9m	5,8m	8,7m	11,6m	14,5m	21,8m	29,1m	43,6m	58,1m	72,7m	87,2m	116,3m	145,4m
Beam wid.	9,6ft	19,2ft	28,5ft	38,1ft	47,7ft	71,5ft	95,4ft	143ft	190,7ft	238,4ft	286,1ft	381,4ft	476,8ft

## LINEAR DISTRIBUTION DIAGRAM

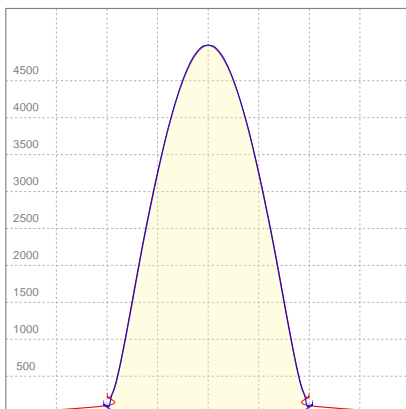

## ELECTRICAL SPECIFICATIONS

Input voltage	Input current	Input power	Efficiency
225V	1,03A	228W	62lm/W

## ISO CANDELA DIAGRAM

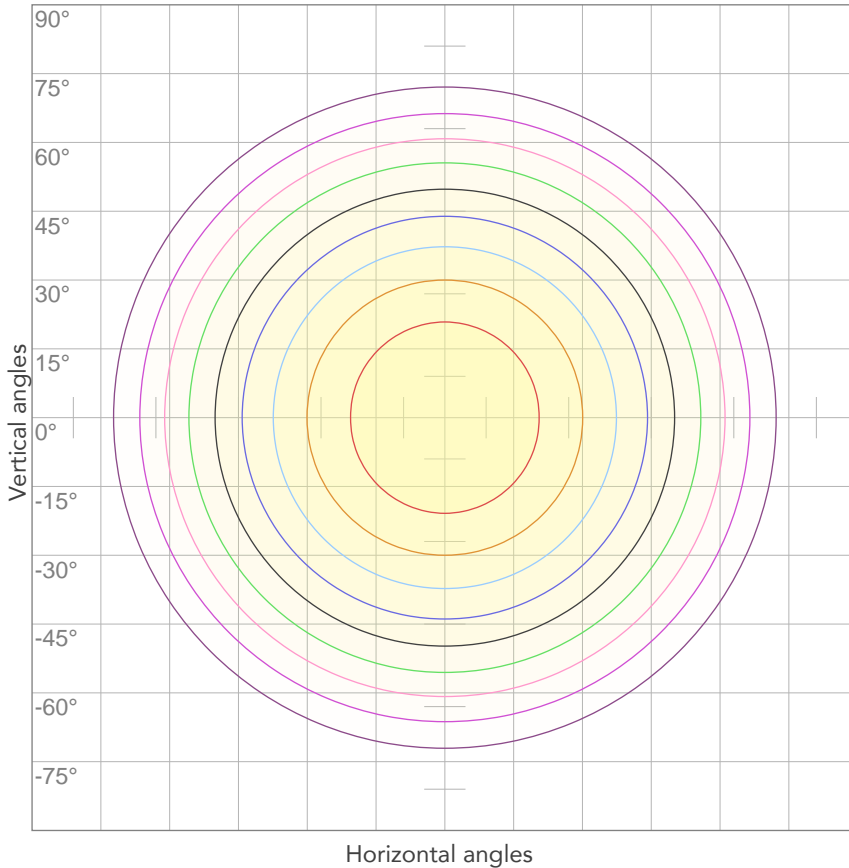

10%	498 cd
20%	996 cd
30%	1494 cd
40%	1991 cd
50%	2489 cd
60%	2987 cd
70%	3485 cd
80%	3983 cd

Conditions:

Number of c-planes: 4

Candela at center: 4978 cd

## ISO LUX DIAGRAM

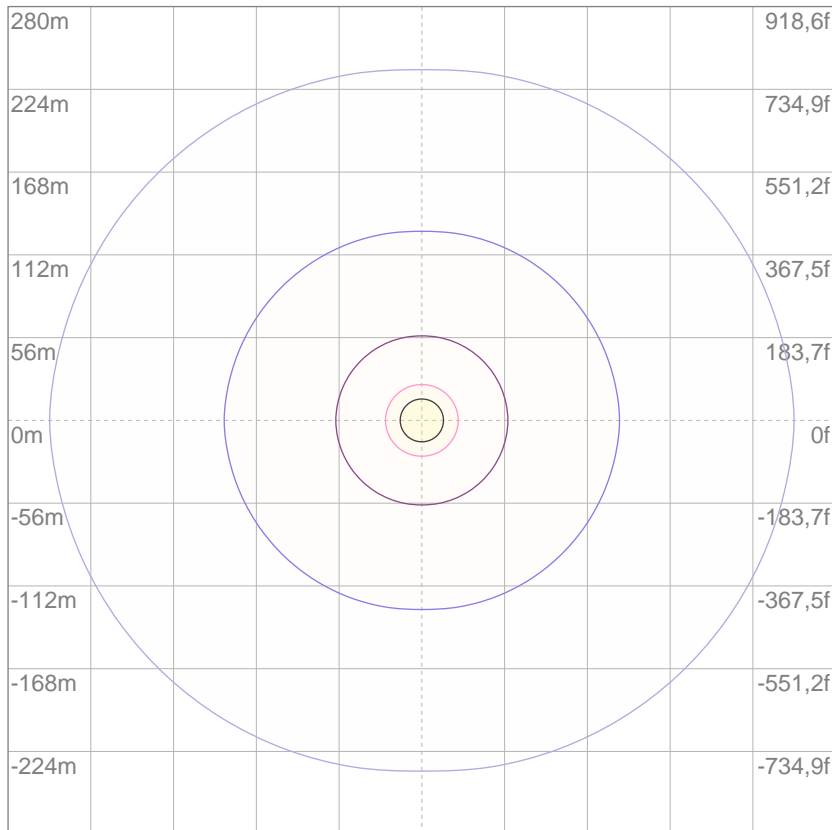

3%	1,49 lx
5%	2,49 lx
10%	4,98 lx
30%	14,9 lx
50%	24,9 lx

Conditions:

Number of c-planes: 4

Lux at center: 49,8 lx

*Lux distribution on a surface when lamp is mounted at 10 meters from the surface.*

Mounting height: 10 meters (33 feet)



Total lumen output:

16747 lm

Peak candela output:

6452 cd

Light quality:

CRI: 88,3

Color temperature:

2843 K

**PRODUCT NAME:**

ECLPANEL TWCJR

**MEASUREMENT CONDITIONS:**

Beam angle:

Filter MD

Target:

2800K

Operator:

Paolo Carvone

Date and time:

14/05/2020 16:04:03

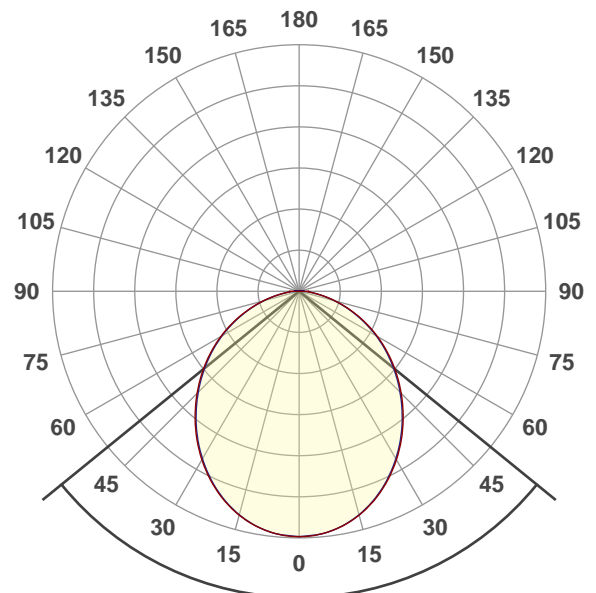

Beam angle 50%: 101,8°

Field angle 10%: 158,3°

Cut off angle 2.5%: 177,2°

Spectra

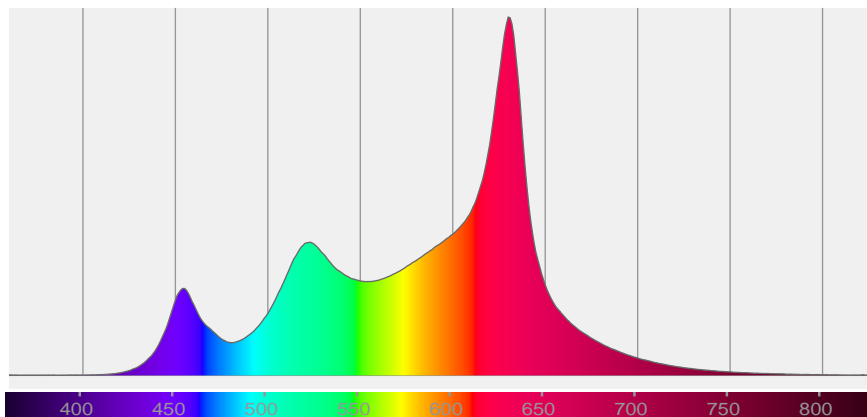

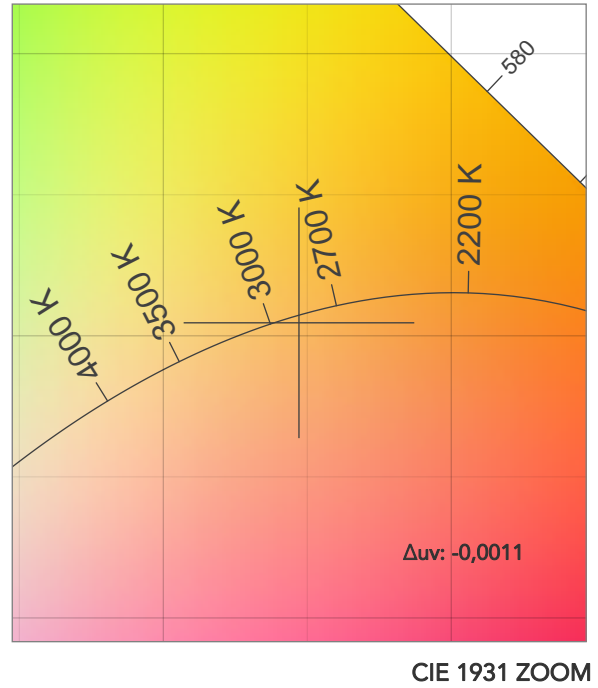
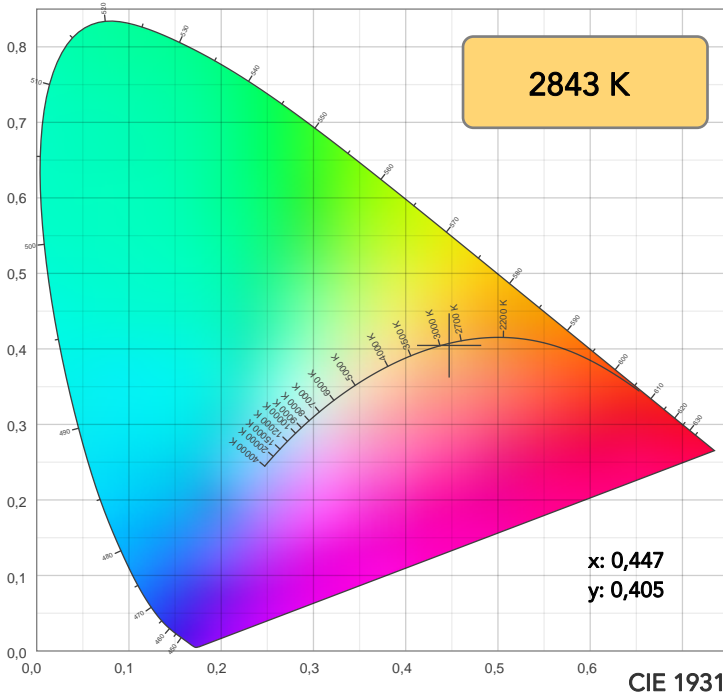

TM30: 88,7

CRI: 88,3 (R1-R8)

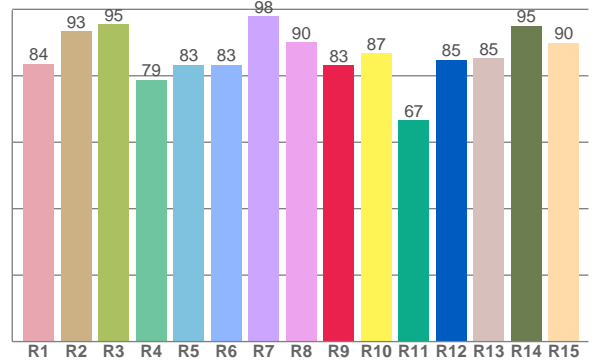
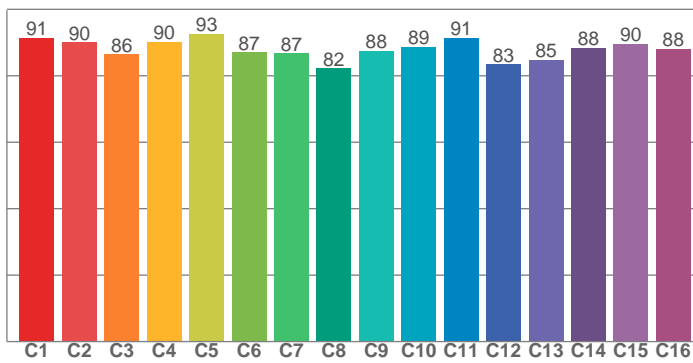

CRI R values, only R1-R8 are used to calculate final CRI value

R1	R2	R3	R4	R5	R6	R7	R8	R9	R10	R11	R12	R13	R14	R15
83,7	93,4	95,5	78,8	83,3	83,4	97,9	90,1	83,1	86,7	66,6	84,8	85,2	95,0	89,9

TM30 C values, 16 binned values out of total of 99 C values

C1	C2	C3	C4	C5	C6	C7	C8	C9	C10	C11	C12	C13	C14	C15	C16
91,5	90,1	86,5	90,2	92,5	87,1	86,7	82,3	87,5	88,7	91,3	83,4	84,7	88,4	89,6	88,1

CQS Q values

Q1	Q2	Q3	Q4	Q5	Q6	Q7	Q8	Q9	Q10	Q11	Q12	Q13	Q14	Q15
93,6	93,0	95,2	87,0	85,7	86,6	95,5	92,6	94,9	93,9	86,9	86,3	89,0	92,3	93,0

CQS: 90,2

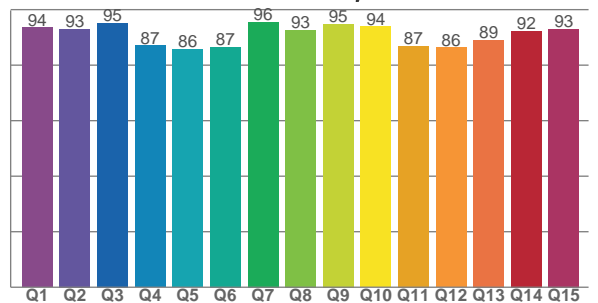

COLOR PARAMETERS

Color temperature	Color rendering index	Red component	Color fidelity	Color gamut	Color quality scale	Television lighting index	Color coordinate cie 1931	Color coordinate cie 1931	Color deviation from black body
CCT	CRI	CRI R9	TM30 Rf	TM30 Rg	CQS	TLCI	x	y	Δuv
2843 K	88,3	83,1	88,7	105,0	90,2	78	0,447	0,405	-0,0011

# TM30 DETAILS

**Rf 88,7**  
Fidelity index Rf

**Rg 105,0**  
Gammut index

Hue Bin	R <sub>f</sub>	Graphic shifts (%)	
		Chroma	Hue
1	91	2%	0%
2	90	4%	-3%
3	86	2%	-4%
4	90	-3%	-5%
5	93	-1%	2%
6	87	5%	7%
7	87	4%	5%
8	82	10%	0%
9	88	6%	-1%
10	89	4%	-4%
11	91	4%	-3%
12	83	4%	-8%
13	85	1%	-11%
14	88	1%	-6%
15	90	0%	2%
16	88	2%	-7%

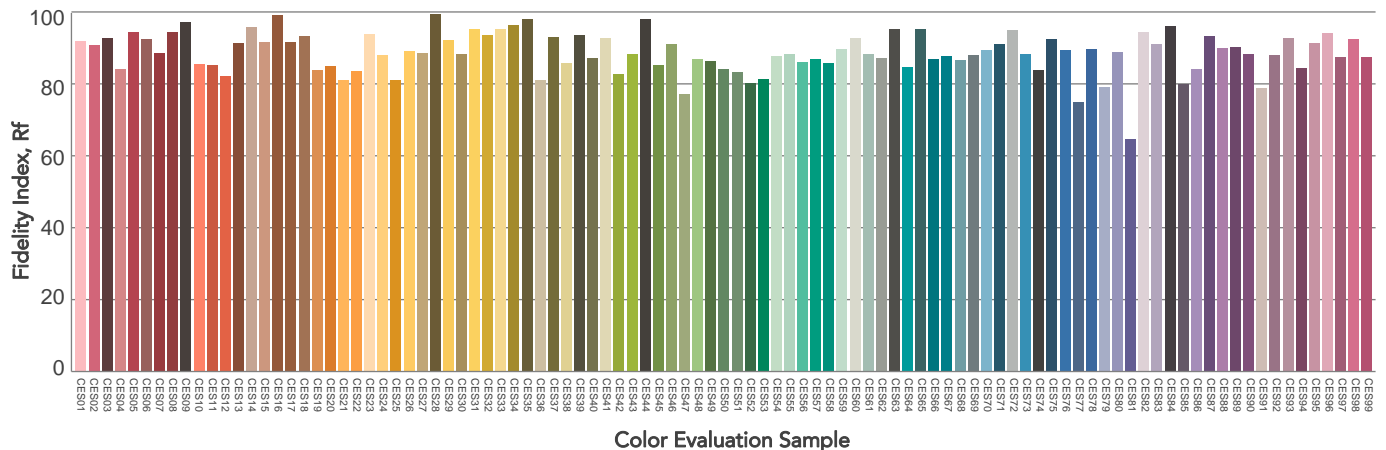
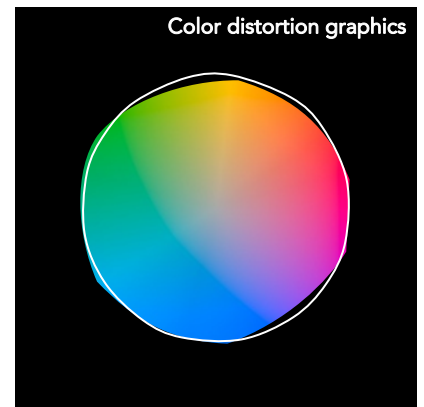
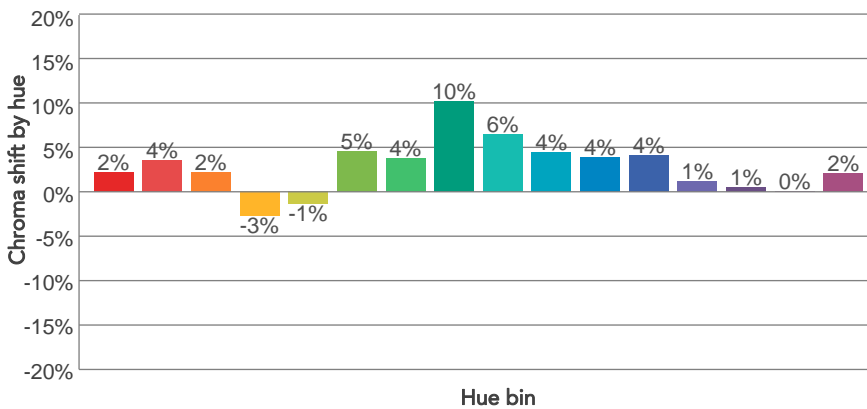
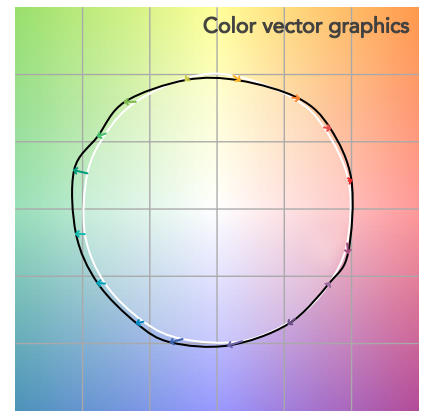
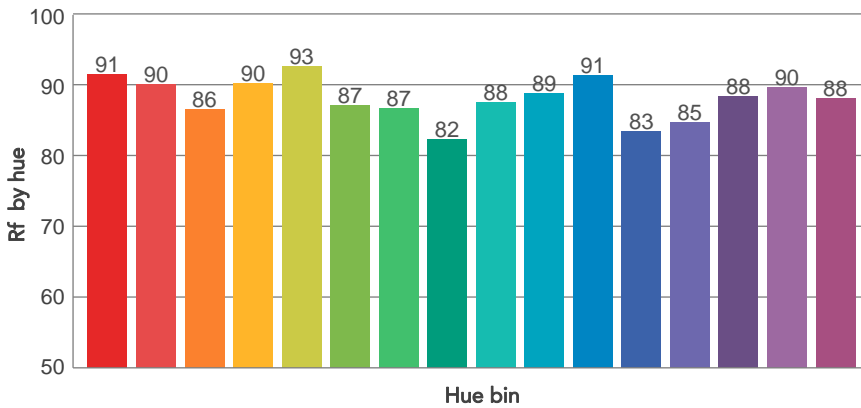
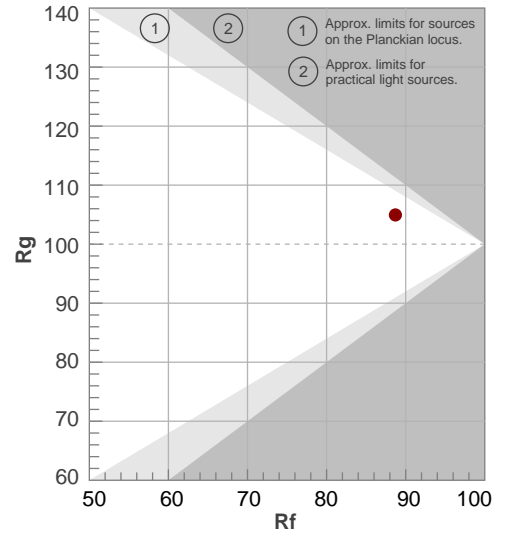



# BEAM DETAILS



Beam angle 50%	Field angle 10%	Cut off angle 2,5%	Intensity ratio in 120° cone	Intensity ratio in 90° cone
101,8°	158,3°	177,2°	79,0%	55,3%

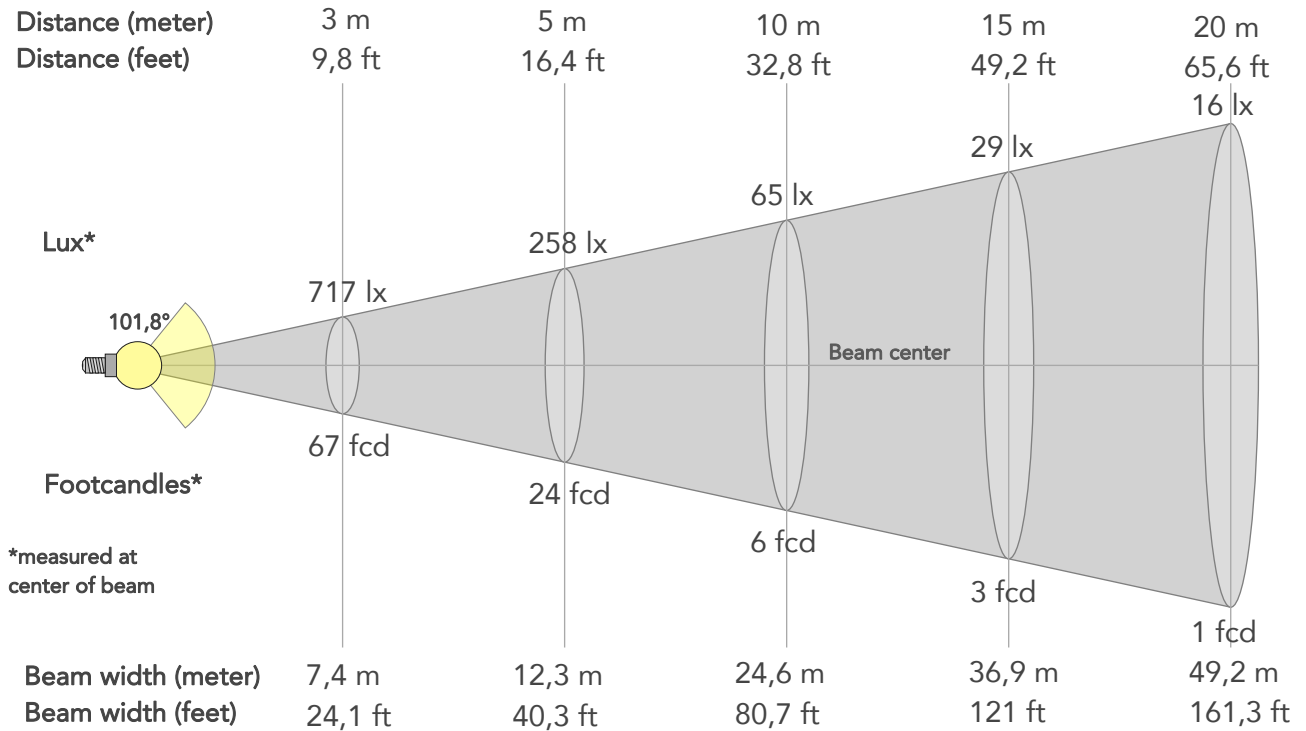

## BEAM INTENSITIES AND WIDTHS

Distance	1m	2m	3m	4m	5m	7,5m	10m	15m	20m	25m	30m	40m	50m
Distance	3,3ft	6,6ft	9,8ft	13,1ft	16,4ft	24,6ft	32,8ft	49,2ft	65,6ft	82ft	98,4ft	131,2ft	164ft
Lux	6451lx	1613lx	717lx	403lx	258lx	115lx	65lx	29lx	16lx	10lx	7lx	4lx	3lx
Footcand.	599fcd	150fcd	67fcd	37fcd	24fcd	11fcd	6fcd	3fcd	1fcd	1fcd	1fcd	0fcd	0fcd
Beam wid.	2,5m	4,9m	7,4m	9,8m	12,3m	18,4m	24,6m	36,9m	49,2m	61,5m	73,8m	98,4m	123m
Beam wid.	8,1ft	16,2ft	24,1ft	32,2ft	40,3ft	60,5ft	80,7ft	121ft	161,3ft	201,7ft	242ft	322,7ft	403,4ft

## LINEAR DISTRIBUTION DIAGRAM

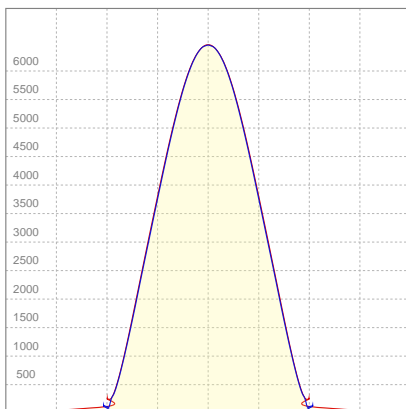

## ELECTRICAL SPECIFICATIONS

Input voltage	Input current	Input power	Effeciency
225V	1,03A	227,9W	73lm/W

## ISO CANDELA DIAGRAM

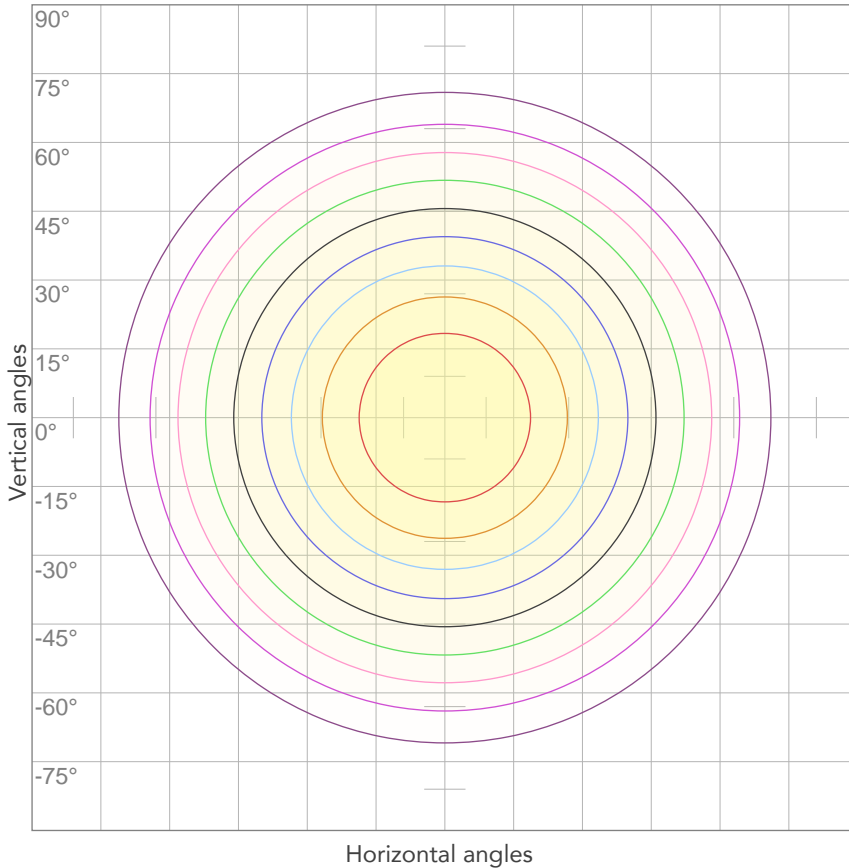

10%	645 cd
20%	1290 cd
30%	1935 cd
40%	2580 cd
50%	3226 cd
60%	3871 cd
70%	4516 cd
80%	5161 cd

Conditions:

Number of c-planes: 4

Candela at center: 6451 cd

## ISO LUX DIAGRAM

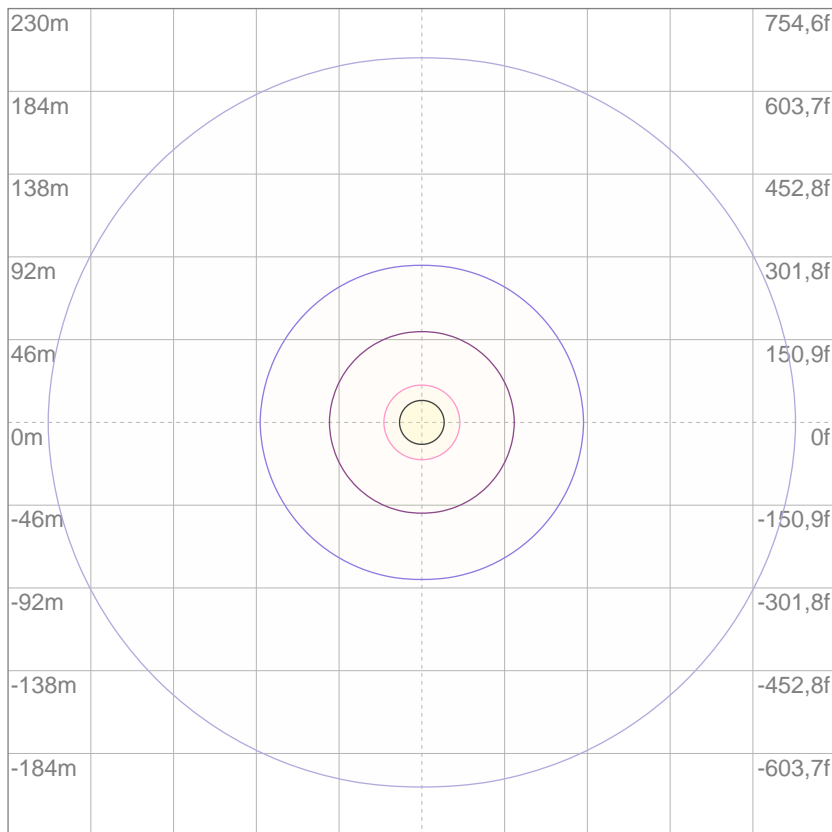

3%	1,94 lx
5%	3,23 lx
10%	6,45 lx
30%	19,4 lx
50%	32,3 lx

Conditions:

Number of c-planes: 4

Lux at center: 64,5 lx

*Lux distribution on a surface when lamp is mounted at 10 meters from the surface.*



Total lumen output:

17408 lm

Peak candela output:

6662 cd

Light quality:

CRI: 88,5

Color temperature:

2857 K

**PRODUCT NAME:**

ECLPANEL TWCJR

**MEASUREMENT CONDITIONS:**

Beam angle:

Filter LD

Target:

2800K

Operator:

Paolo Carvone

Date and time:

14/05/2020 15:47:30

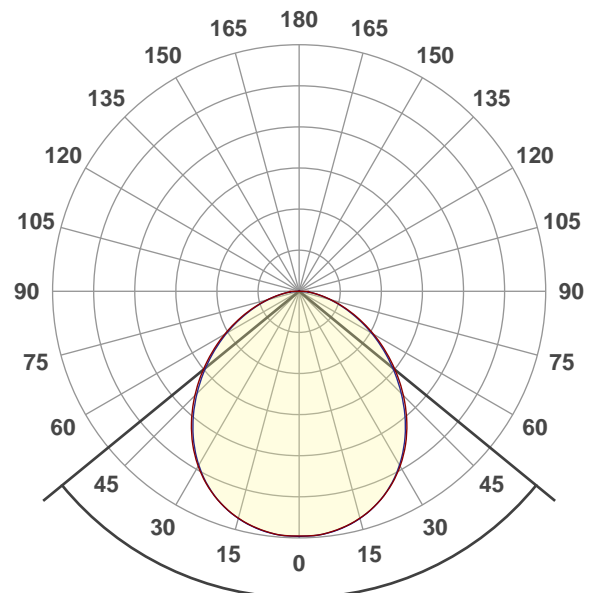

Beam angle 50%: 101,4°

Field angle 10%: 155,9°

Cut off angle 2.5%: 174,9°

Spectra

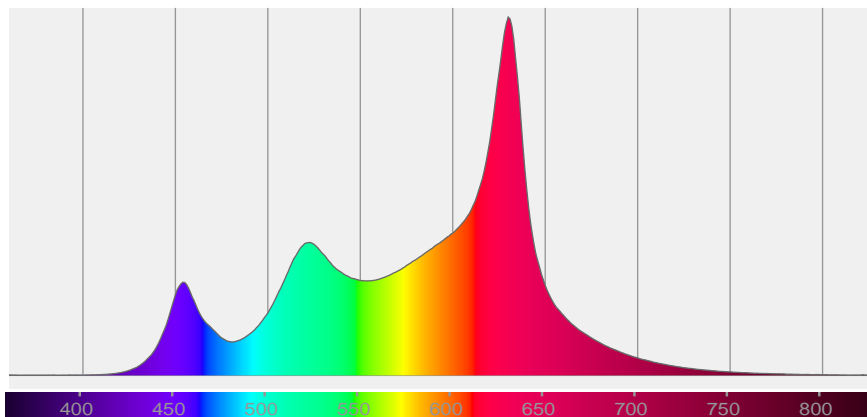

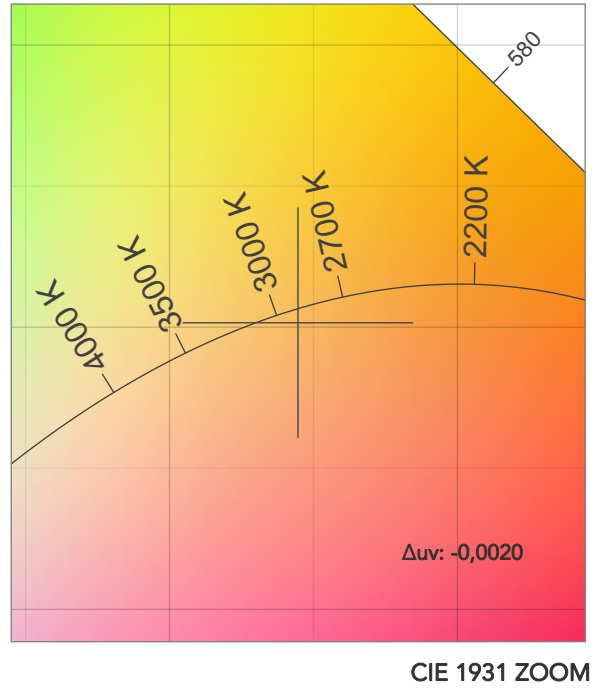
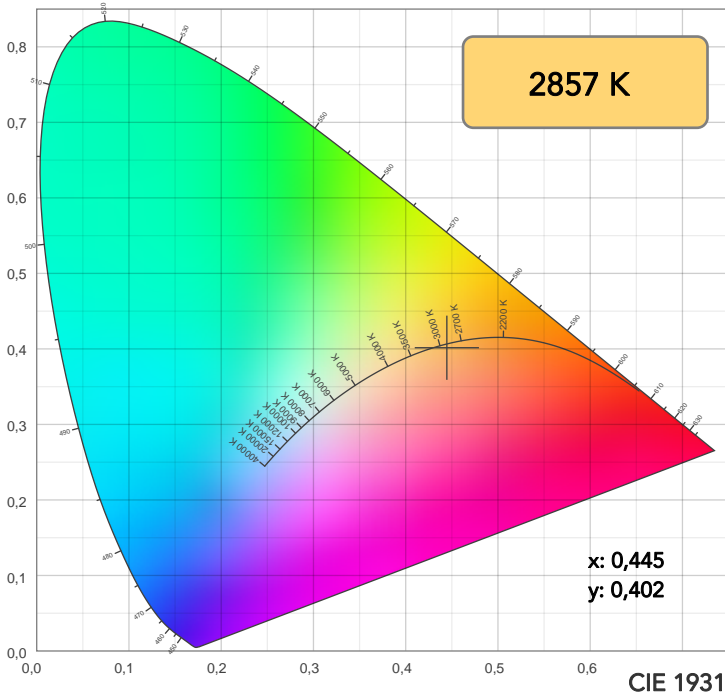

TM30: 88,9

CRI: 88,5 (R1-R8)

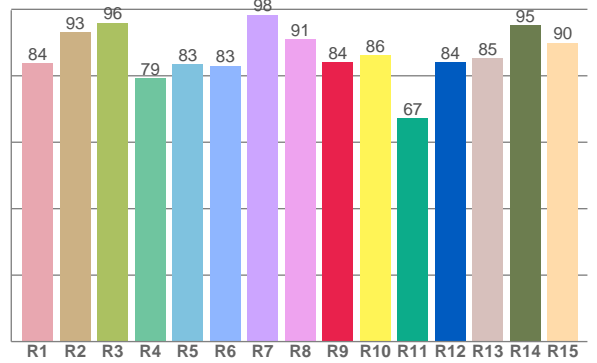
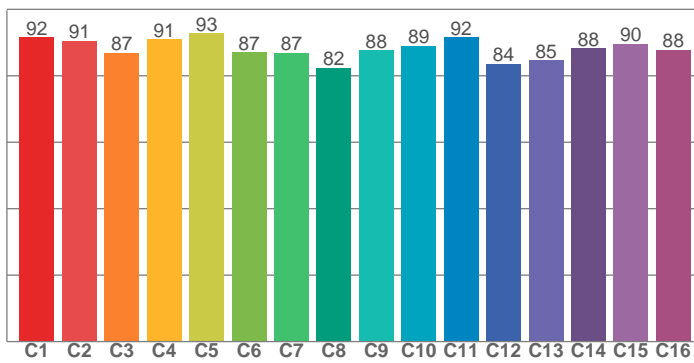

CRI R values, only R1-R8 are used to calculate final CRI value

R1	R2	R3	R4	R5	R6	R7	R8	R9	R10	R11	R12	R13	R14	R15
83,8	93,2	96,0	79,3	83,4	83,1	98,4	90,9	84,1	86,3	67,2	84,0	85,2	95,3	89,9

TM30 C values, 16 binned values out of total of 99 C values

C1	C2	C3	C4	C5	C6	C7	C8	C9	C10	C11	C12	C13	C14	C15	C16
91,6	90,5	87,0	91,0	92,7	87,0	87,0	82,4	87,7	89,0	91,5	83,6	84,7	88,2	89,7	87,7

CQS Q values

Q1	Q2	Q3	Q4	Q5	Q6	Q7	Q8	Q9	Q10	Q11	Q12	Q13	Q14	Q15
94,0	93,1	95,9	87,9	86,1	86,4	94,9	93,7	96,0	94,7	87,9	87,5	90,0	92,0	93,2

CQS: 90,7

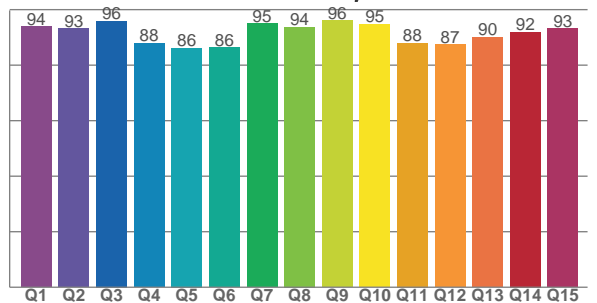

COLOR PARAMETERS

Color temperature	Color rendering index	Red component	Color fidelity	Color gamut	Color quality scale	Television lighting index	Color coordinate cie 1931	Color coordinate cie 1931	Color deviation from black body
CCT	CRI	CRI R9	TM30 Rf	TM30 Rg	CQS	TLCI	x	y	Δuv
2857 K	88,5	84,1	88,9	105,4	90,7	79	0,445	0,402	-0,0020

# TM30 DETAILS

**Rf 88,9**  
Fidelity index Rf

**Rg 105,4**  
Gammut index

Hue Bin	R <sub>f</sub>	Graphic shifts (%)	
		Chroma	Hue
1	92	2%	0%
2	91	3%	-3%
3	87	2%	-4%
4	91	-2%	-5%
5	93	-1%	2%
6	87	5%	6%
7	87	4%	4%
8	82	10%	-1%
9	88	6%	-2%
10	89	4%	-3%
11	92	4%	-3%
12	84	4%	-8%
13	85	1%	-11%
14	88	1%	-7%
15	90	0%	2%
16	88	2%	-7%

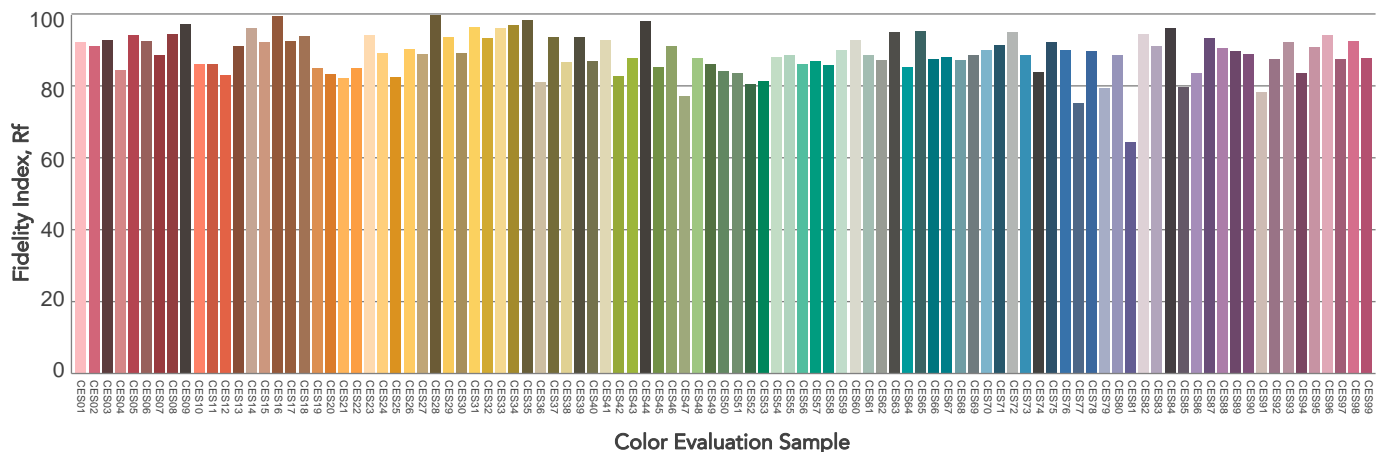
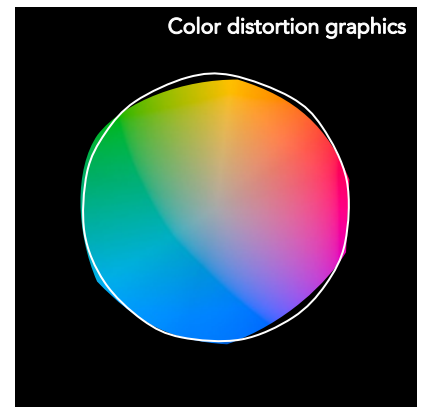
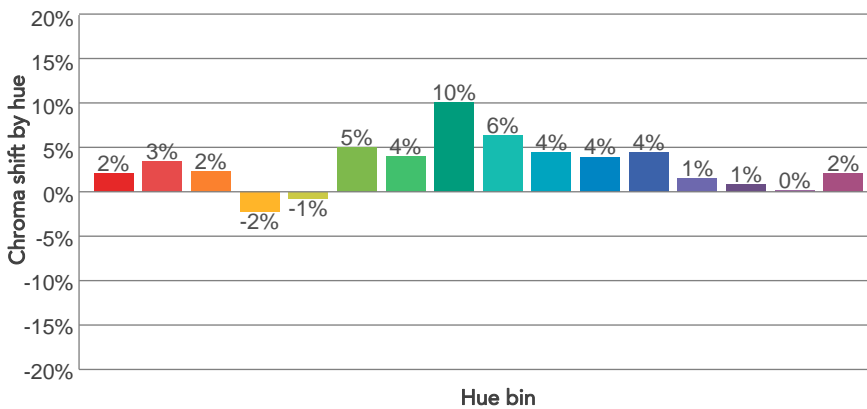
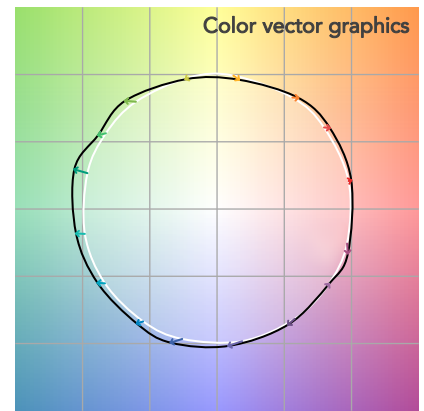
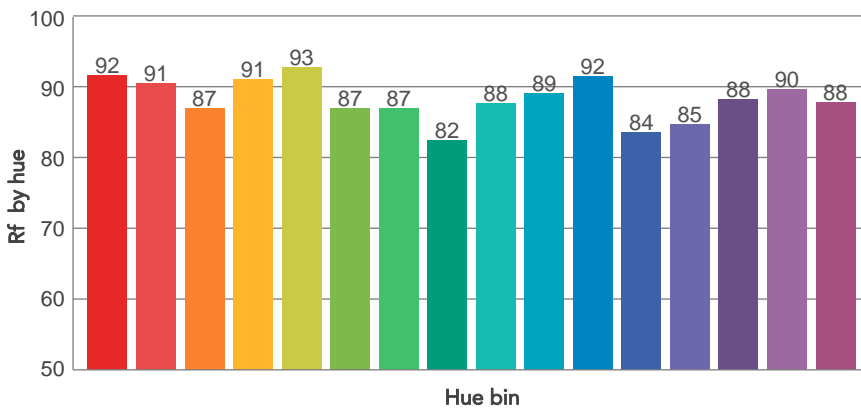
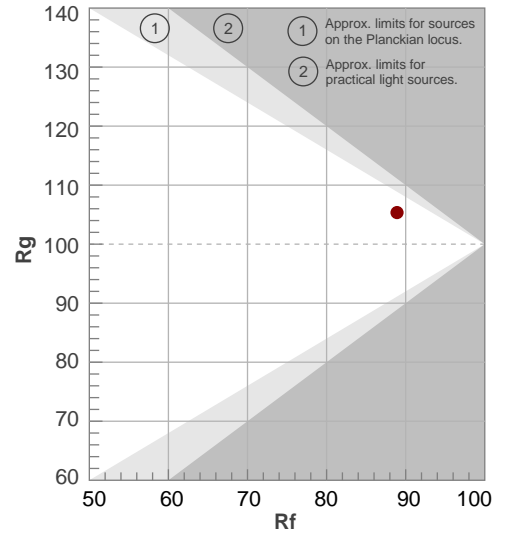

# BEAM DETAILS



Beam angle 50%	Field angle 10%	Cut off angle 2,5%	Intensity ratio in 120° cone	Intensity ratio in 90° cone
101,4°	155,9°	174,9°	79,7%	56,4%

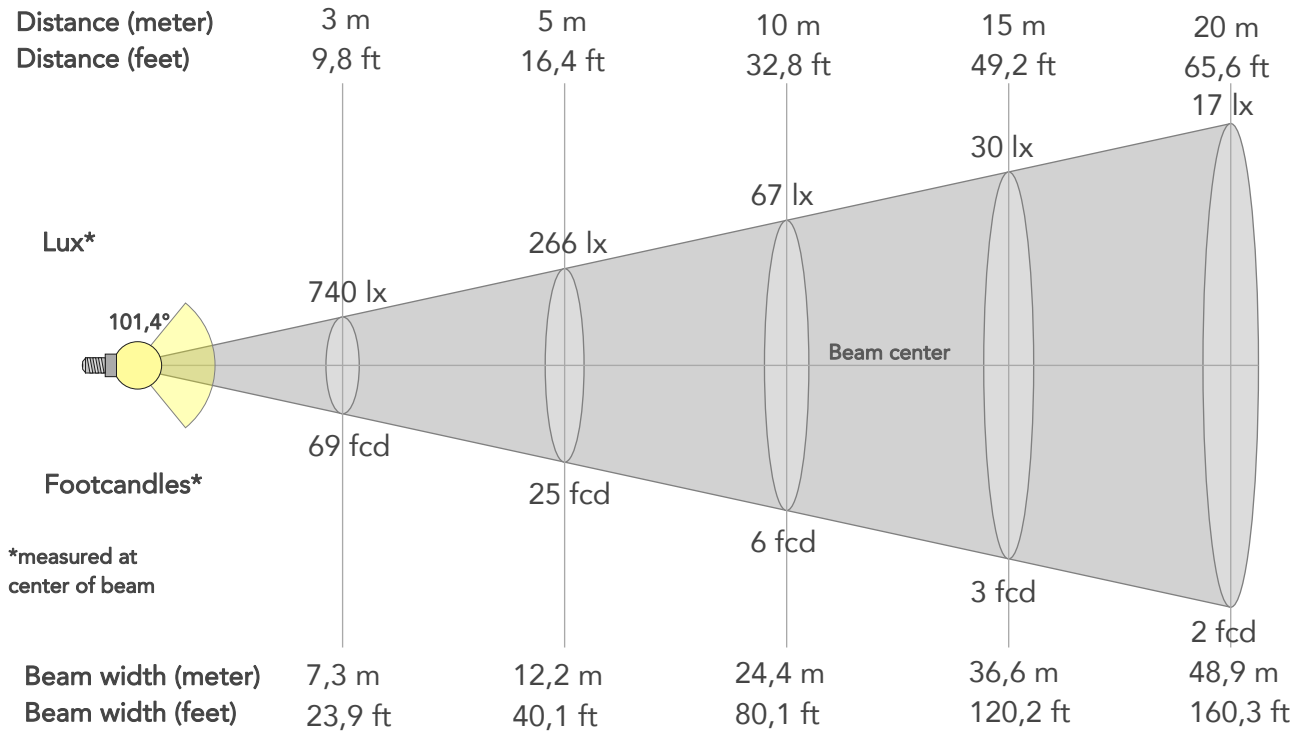

## BEAM INTENSITIES AND WIDTHS

Distance	1m	2m	3m	4m	5m	7,5m	10m	15m	20m	25m	30m	40m	50m
Distance	3,3ft	6,6ft	9,8ft	13,1ft	16,4ft	24,6ft	32,8ft	49,2ft	65,6ft	82ft	98,4ft	131,2ft	164ft
Lux	6657lx	1664lx	740lx	416lx	266lx	118lx	67lx	30lx	17lx	11lx	7lx	4lx	3lx
Footcand.	618fcd	155fcd	69fcd	39fcd	25fcd	11fcd	6fcd	3fcd	2fcd	1fcd	1fcd	0fcd	0fcd
Beam wid.	2,4m	4,9m	7,3m	9,8m	12,2m	18,3m	24,4m	36,6m	48,9m	61,1m	73,3m	97,7m	122,1m
Beam wid.	8,1ft	16,1ft	23,9ft	32ft	40,1ft	60,1ft	80,1ft	120,2ft	160,3ft	200,3ft	240,4ft	320,5ft	400,6ft

## LINEAR DISTRIBUTION DIAGRAM

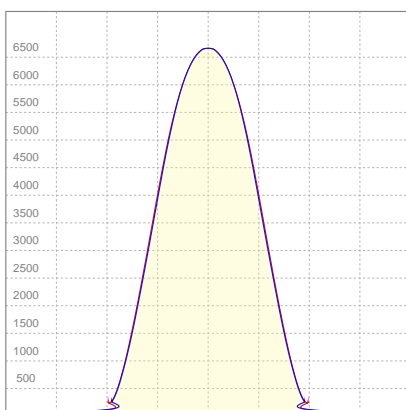

## ELECTRICAL SPECIFICATIONS

Input voltage	Input current	Input power	Effeciency
224V	1,04A	228,1W	76lm/W

## ISO CANDELA DIAGRAM

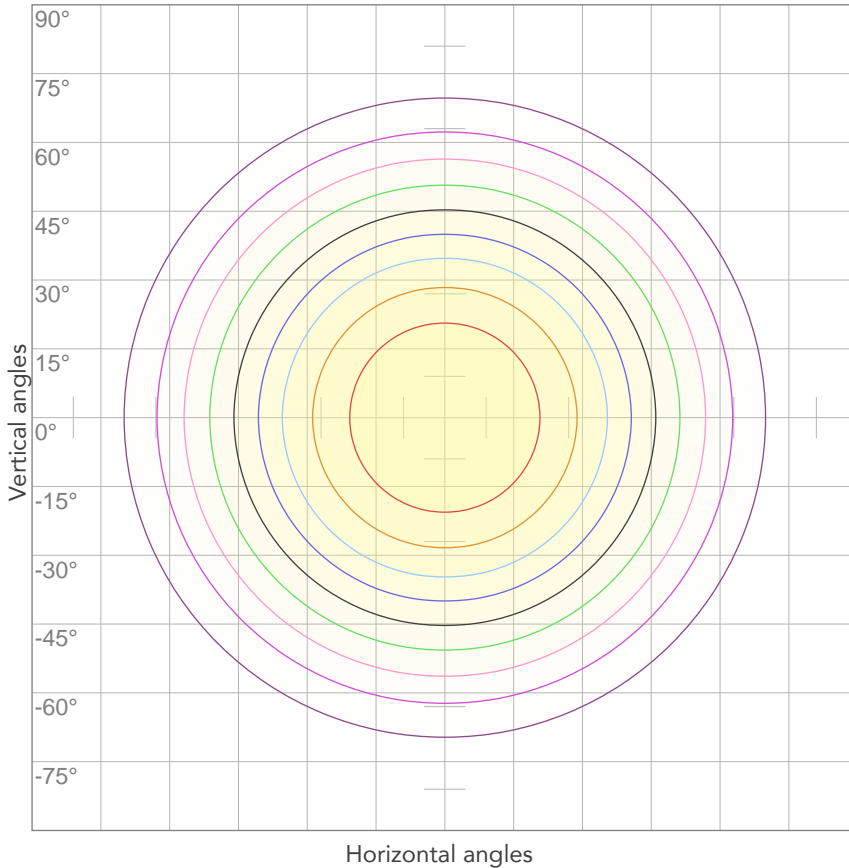

10%	666 cd
20%	1331 cd
30%	1997 cd
40%	2663 cd
50%	3328 cd
60%	3994 cd
70%	4660 cd
80%	5325 cd

Conditions:

Number of c-planes: 4

Candela at center: 6657 cd

## ISO LUX DIAGRAM

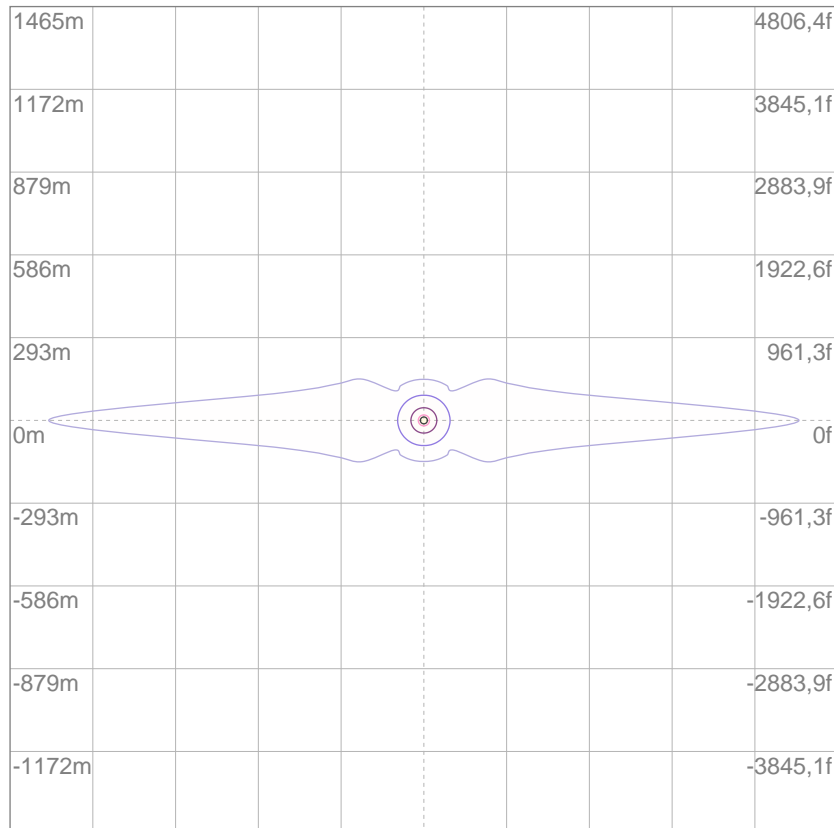

Mounting height: 10 meters (33 feet)

3%	2,00 lx
5%	3,33 lx
10%	6,66 lx
30%	20,0 lx
50%	33,3 lx

Conditions:

Number of c-planes: 4

Lux at center: 66,6 lx

*Lux distribution on a surface when lamp is mounted at 10 meters from the surface.*



Total lumen output:

14497 lm

Peak candela output:

9551 cd

Light quality:

CRI: 86,9

Color temperature:

2722 K

**PRODUCT NAME:**

ECLPANEL TWCJR

**MEASURAMENT CONDITIONS:**

Beam angle:

Filter INT

Target:

2800K

Operator:

Paolo Carvone

Date and time:

13/11/2020 12:09:42

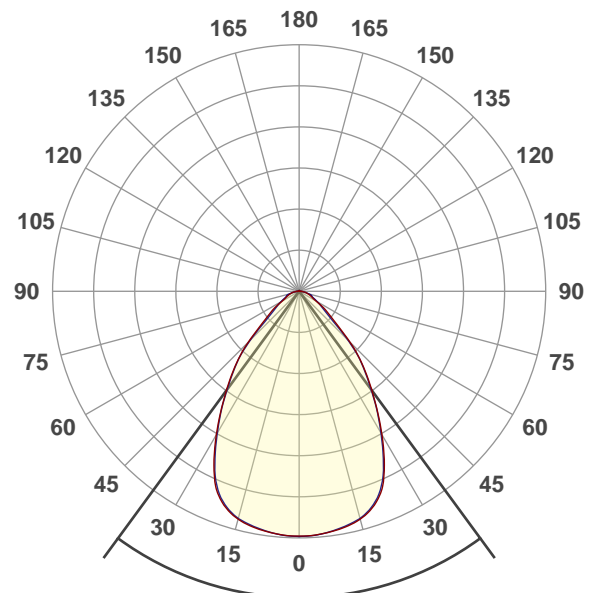

Beam angle 50%: 72,5°

Field angle 10%: 115,2°

Cut off angle 2.5%: 160,4°

Spectra

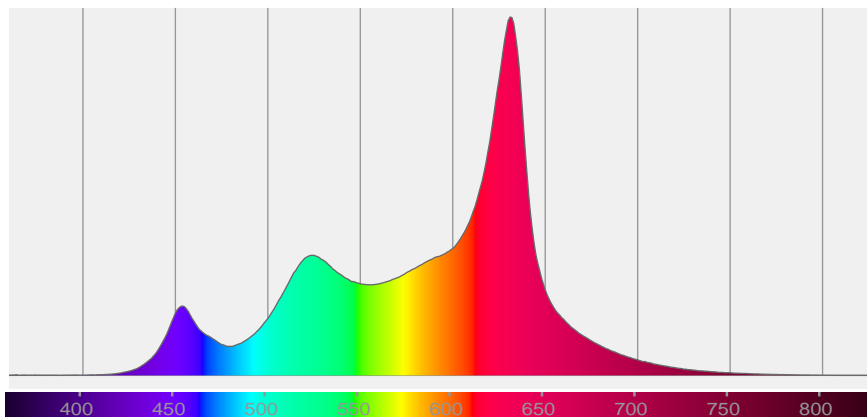



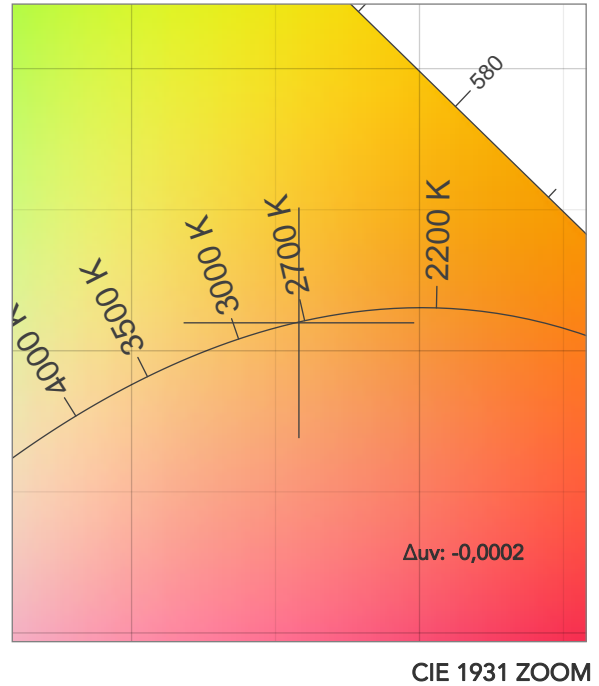
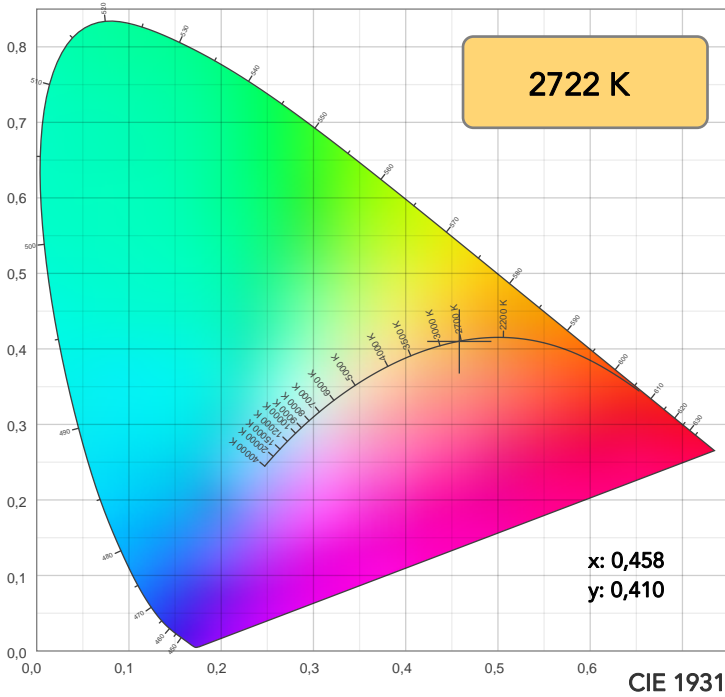

TM30: 88,3

CRI: 86,9 (R1-R8)

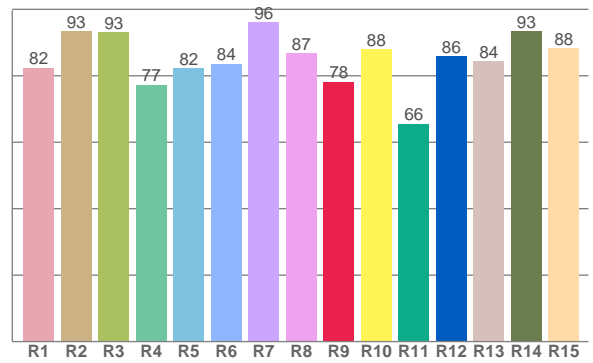
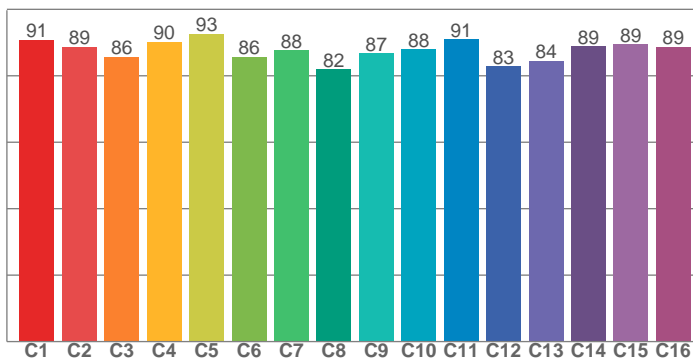

CRI R values, only R1-R8 are used to calculate final CRI value

R1	R2	R3	R4	R5	R6	R7	R8	R9	R10	R11	R12	R13	R14	R15
82,5	93,5	93,1	77,3	82,3	83,7	96,1	86,9	78,2	88,0	65,6	85,9	84,4	93,4	88,2

TM30 C values, 16 binned values out of total of 99 C values

C1	C2	C3	C4	C5	C6	C7	C8	C9	C10	C11	C12	C13	C14	C15	C16
90,9	88,7	85,7	90,2	92,6	85,6	87,7	82,0	86,7	88,0	91,0	82,8	84,4	88,9	89,5	88,8

CQS Q values

Q1	Q2	Q3	Q4	Q5	Q6	Q7	Q8	Q9	Q10	Q11	Q12	Q13	Q14	Q15
93,4	92,3	94,2	85,7	84,4	85,7	95,3	90,9	93,0	92,2	85,6	84,3	86,6	92,1	92,5

CQS: 89,0

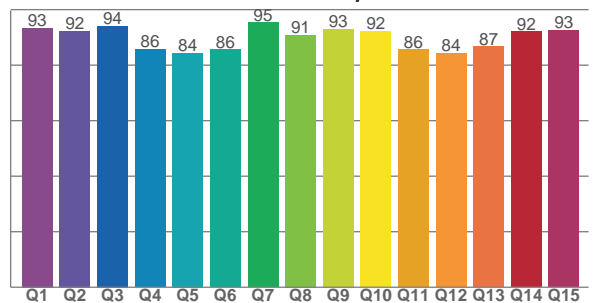

COLOR PARAMETERS

Color temperature	Color rendering index	Red component	Color fidelity	Color gamut	Color quality scale	Television lighting index	Color coordinate cie 1931	Color coordinate cie 1931	Color deviation from black body
CCT	CRI	CRI R9	TM30 Rf	TM30 Rg	CQS	TLCI	x	y	Δuv
2722 K	86,9	78,2	88,3	105,1	89,0	78	0,458	0,410	-0,0002

# TM30 DETAILS

**Rf 88,3**  
Fidelity index Rf

**Rg 105,1**  
Gammut index

Hue Bin	R <sub>f</sub>	Graphic shifts (%)	
		Chroma	Hue
1	91	3%	0%
2	89	4%	-4%
3	86	2%	-5%
4	90	-3%	-5%
5	93	-1%	3%
6	86	5%	8%
7	88	5%	5%
8	82	10%	0%
9	87	6%	-2%
10	88	5%	-5%
11	91	4%	-4%
12	83	4%	-9%
13	84	1%	-11%
14	89	0%	-5%
15	89	0%	2%
16	89	2%	-6%

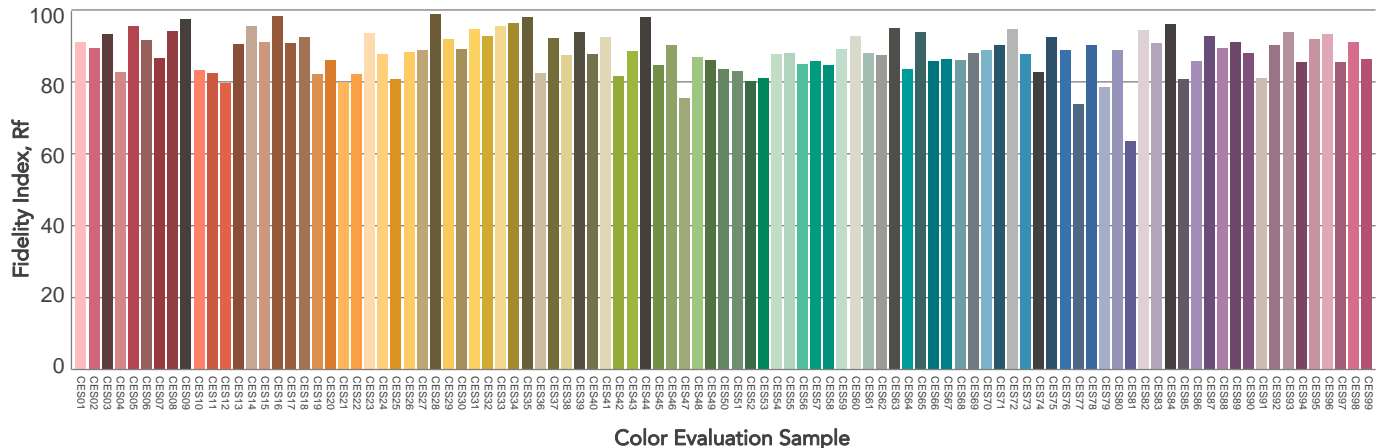
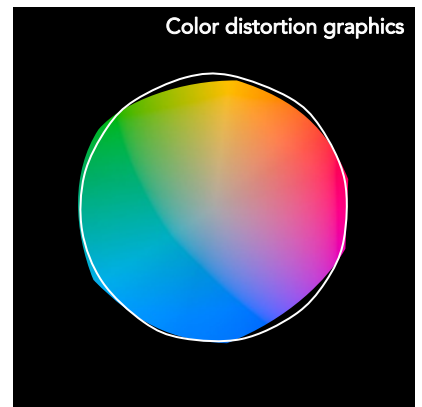
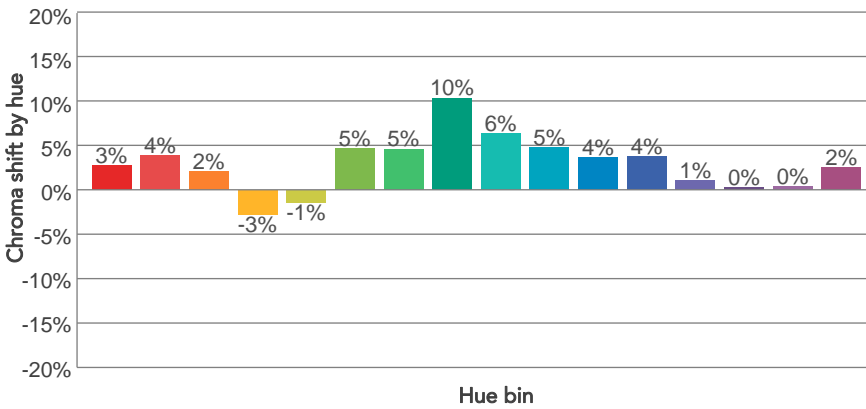
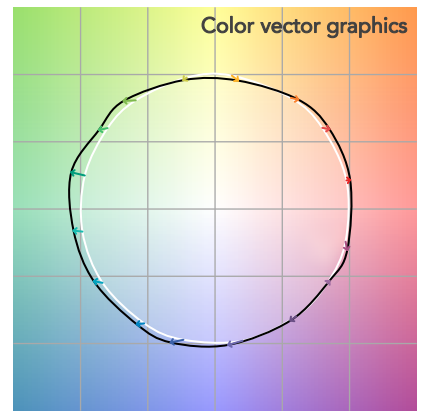
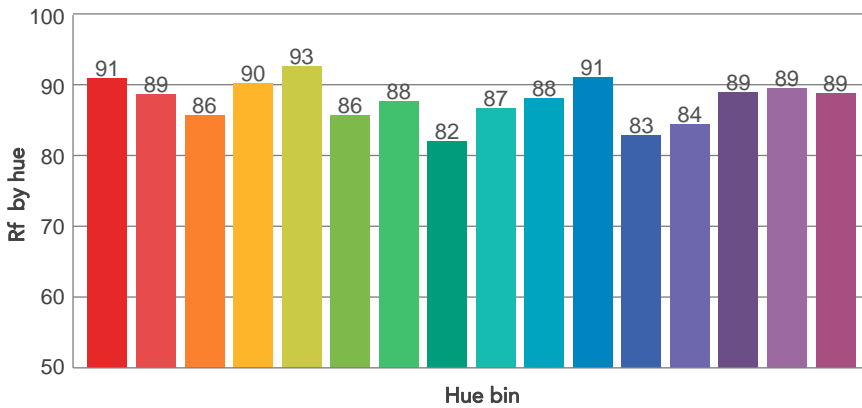
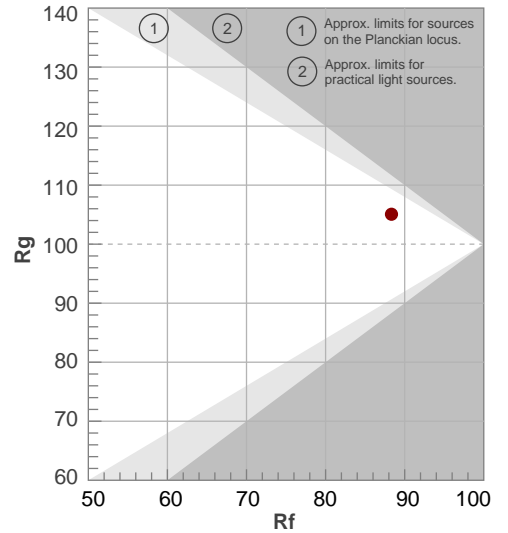

# BEAM DETAILS



Beam angle 50%	Field angle 10%	Cut off angle 2,5%	Intensity ratio in 120° cone	Intensity ratio in 90° cone
72,5°	115,2°	160,4°	92,1%	78,9%

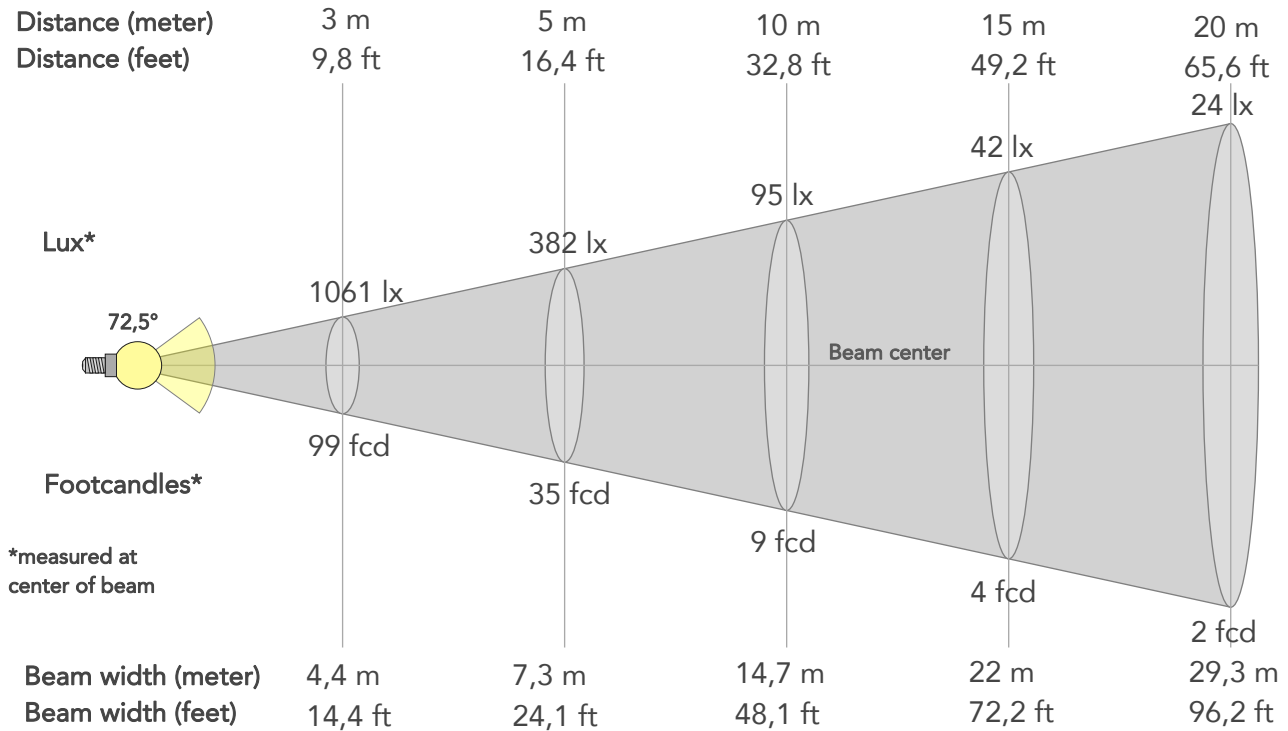

## BEAM INTENSITIES AND WIDTHS

Distance	1m	2m	3m	4m	5m	7,5m	10m	15m	20m	25m	30m	40m	50m
Distance	3,3ft	6,6ft	9,8ft	13,1ft	16,4ft	24,6ft	32,8ft	49,2ft	65,6ft	82ft	98,4ft	131,2ft	164ft
Lux	9545lx	2386lx	1061lx	597lx	382lx	170lx	95lx	42lx	24lx	15lx	11lx	6lx	4lx
Footcand.	887fcd	222fcd	99fcd	55fcd	35fcd	16fcd	9fcd	4fcd	2fcd	1fcd	1fcd	1fcd	0fcd
Beam wid.	1,5m	2,9m	4,4m	5,9m	7,3m	11m	14,7m	22m	29,3m	36,7m	44m	58,7m	73,3m
Beam wid.	4,8ft	9,7ft	14,4ft	19,2ft	24,1ft	36,1ft	48,1ft	72,2ft	96,2ft	120,3ft	144,3ft	192,4ft	240,5ft

## LINEAR DISTRIBUTION DIAGRAM

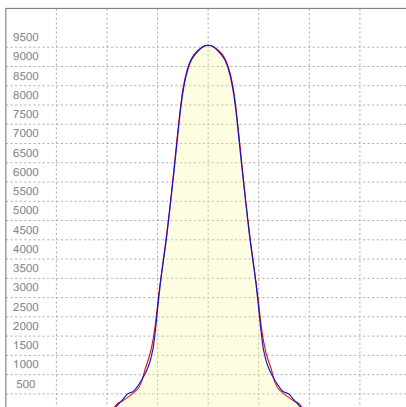

## ELECTRICAL SPECIFICATIONS

Input voltage	Input current	Input power	Effeciency
226V	1,06A	228,9W	63lm/W

## ISO CANDELA DIAGRAM

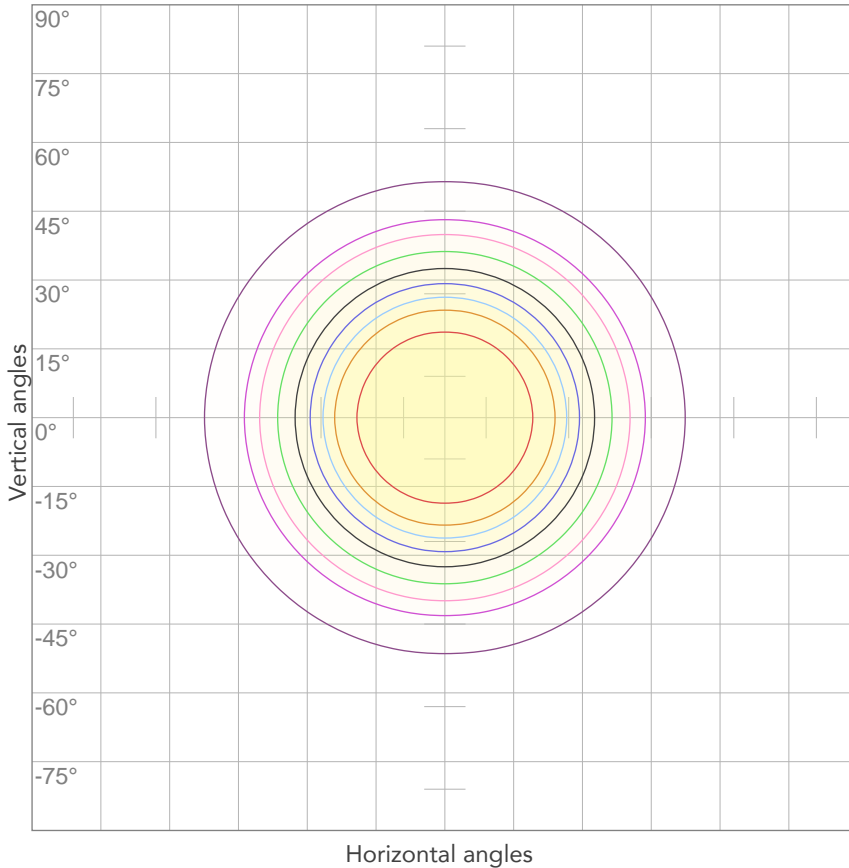

10%	954 cd
20%	1909 cd
30%	2863 cd
40%	3818 cd
50%	4772 cd
60%	5727 cd
70%	6681 cd
80%	7636 cd

Conditions:

Number of c-planes: 4

Candela at center: 9545 cd

## ISO LUX DIAGRAM

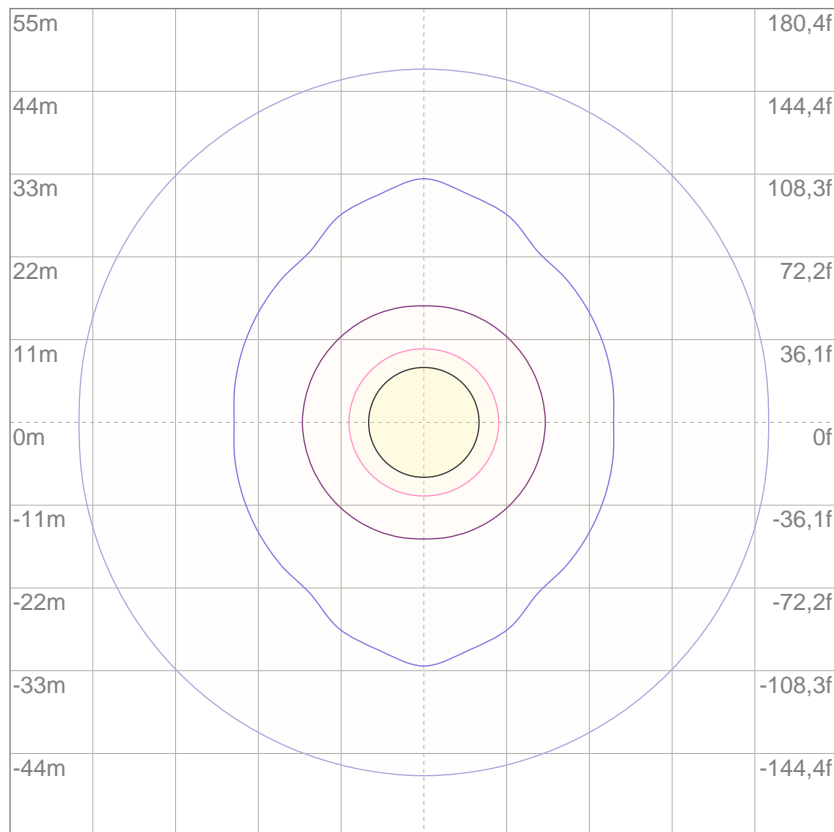

Mounting height: 10 meters (33 feet)

3%	2,86 lx
5%	4,77 lx
10%	9,54 lx
30%	28,6 lx
50%	47,7 lx

Conditions:

Number of c-planes: 4

Lux at center: 95,4 lx

*Lux distribution on a surface when lamp is mounted at 10 meters from the surface.*



Total lumen output:

14605 lm

Peak candela output:

5035 cd

Light quality:

CRI: 87,5

Color temperature:

3298 K

**PRODUCT NAME:**

ECLPANEL TWCJR

**MEASURAMENT CONDITIONS:**

Beam angle:

Filter HD

Target:

3200K

Operator:

Paolo Carvone

Date and time:

14/05/2020 16:23:03

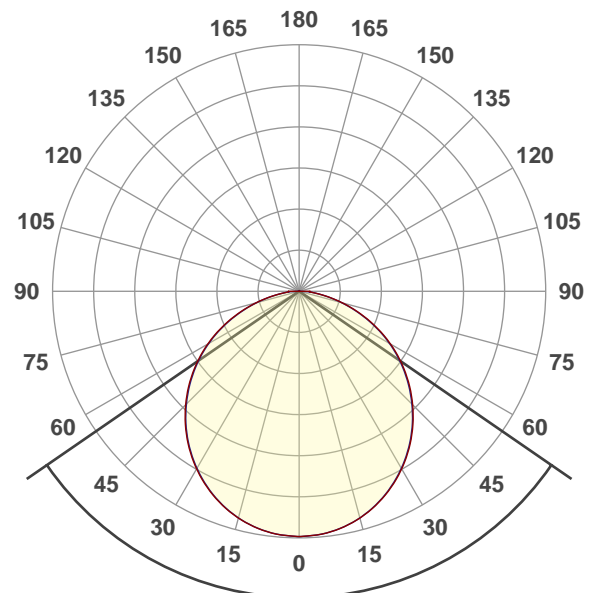

Beam angle 50%: 110,9°

Field angle 10%: 161,2°

Cut off angle 2.5%: 177°

Spectra

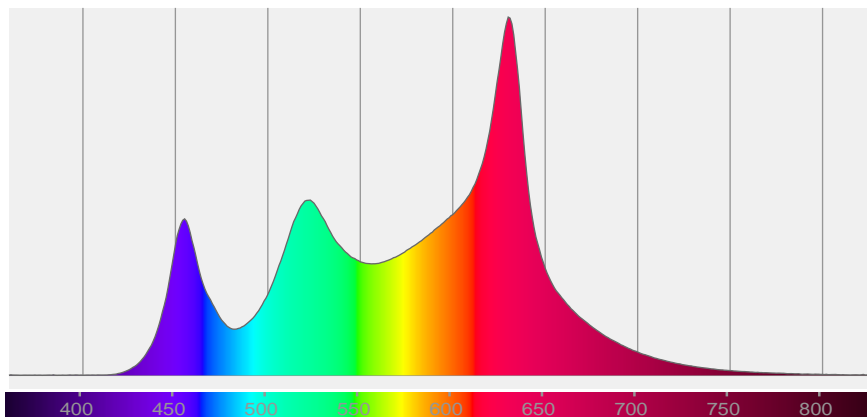

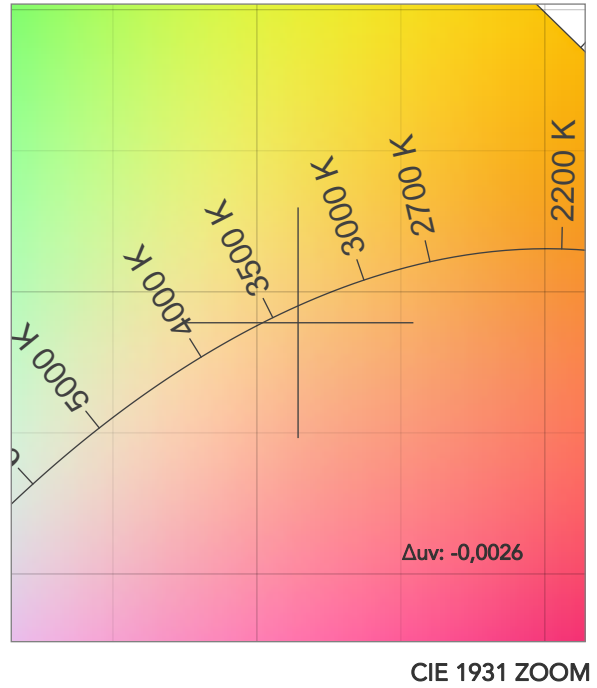
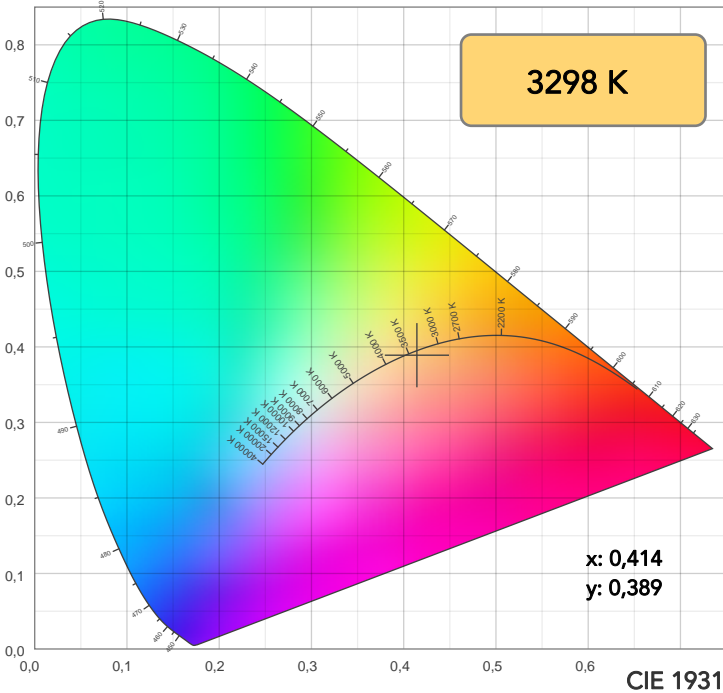

TM30: 88,7

CRI: 87,5 (R1-R8)

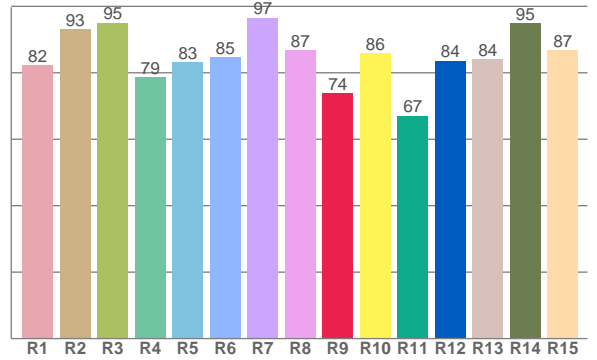
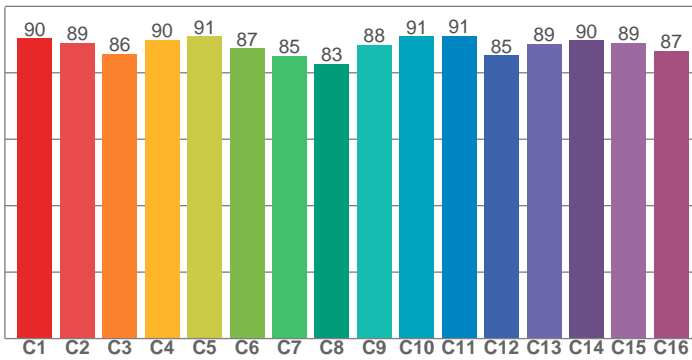

CRI R values, only R1-R8 are used to calculate final CRI value

R1	R2	R3	R4	R5	R6	R7	R8	R9	R10	R11	R12	R13	R14	R15
82,3	93,1	95,0	78,7	83,1	84,6	96,5	86,7	73,8	85,8	67,1	83,7	84,1	94,9	86,8

TM30 C values, 16 binned values out of total of 99 C values

C1	C2	C3	C4	C5	C6	C7	C8	C9	C10	C11	C12	C13	C14	C15	C16
90,3	88,9	85,8	89,8	90,9	87,3	85,1	82,6	88,4	91,0	91,1	85,2	88,7	89,7	88,9	86,6

CQS Q values

Q1	Q2	Q3	Q4	Q5	Q6	Q7	Q8	Q9	Q10	Q11	Q12	Q13	Q14	Q15
93,7	95,5	97,2	90,6	88,4	88,9	96,5	93,4	95,9	95,6	87,8	87,0	89,7	92,8	92,8

CQS: 91,6

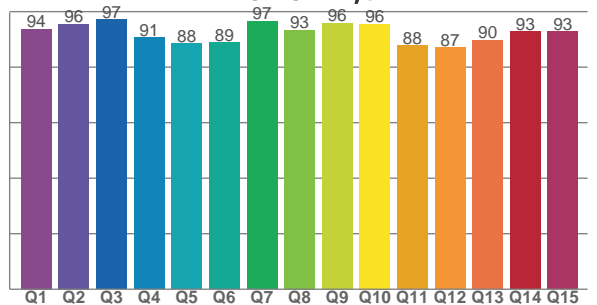

COLOR PARAMETERS

Color temperature	Color rendering index	Red component	Color fidelity	Color gamut	Color quality scale	Television lighting index	Color coordinate cie 1931	Color coordinate cie 1931	Color deviation from black body
CCT	CRI	CRI R9	TM30 Rf	TM30 Rg	CQS	TLCI	x	y	Δuv
3298 K	87,5	73,8	88,7	106,0	91,6	81	0,414	0,389	-0,0026

# TM30 DETAILS

**Rf 88,7**  
Fidelity index Rf

**Rg 106,0**  
Gammut index

Hue Bin	R <sub>f</sub>	Graphic shifts (%)	
		Chroma	Hue
1	90	3%	1%
2	89	4%	-3%
3	86	3%	-5%
4	90	-2%	-5%
5	91	-4%	1%
6	87	4%	6%
7	85	5%	6%
8	83	9%	-1%
9	88	7%	0%
10	91	4%	-2%
11	91	4%	0%
12	85	6%	-7%
13	89	1%	-8%
14	90	2%	-4%
15	89	2%	0%
16	87	5%	-5%

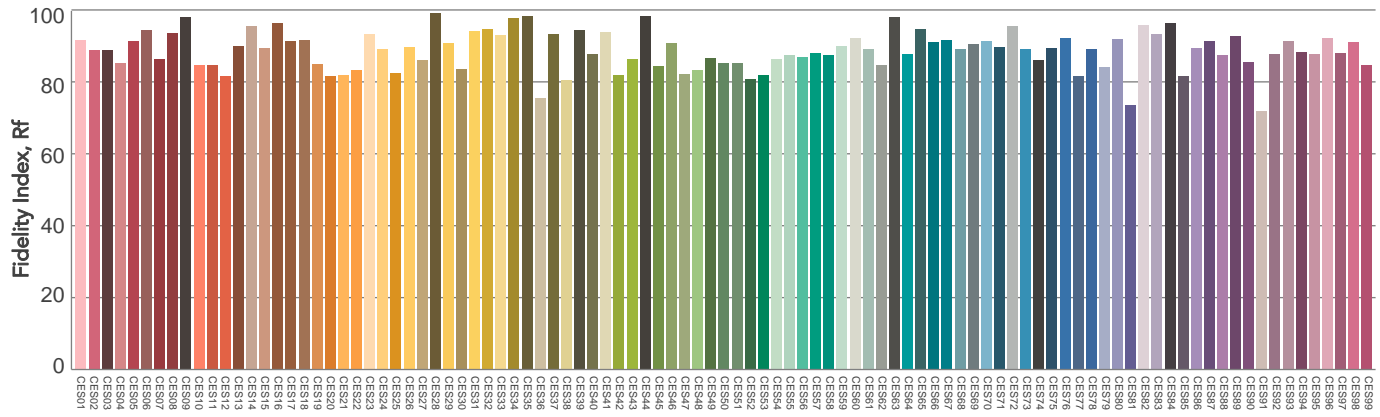
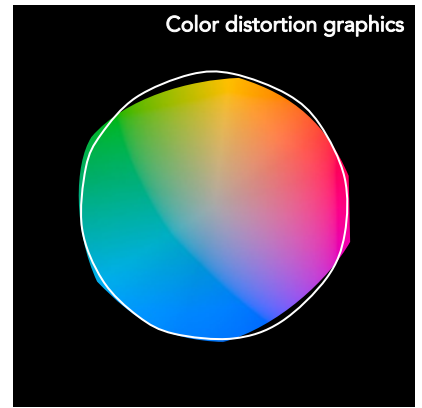
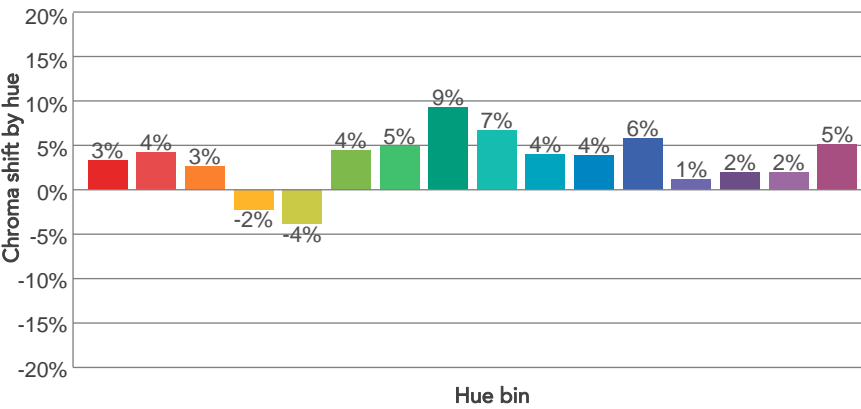
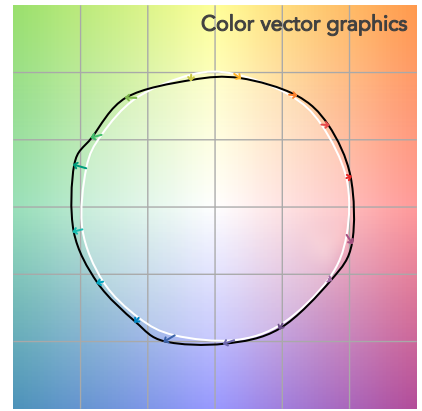
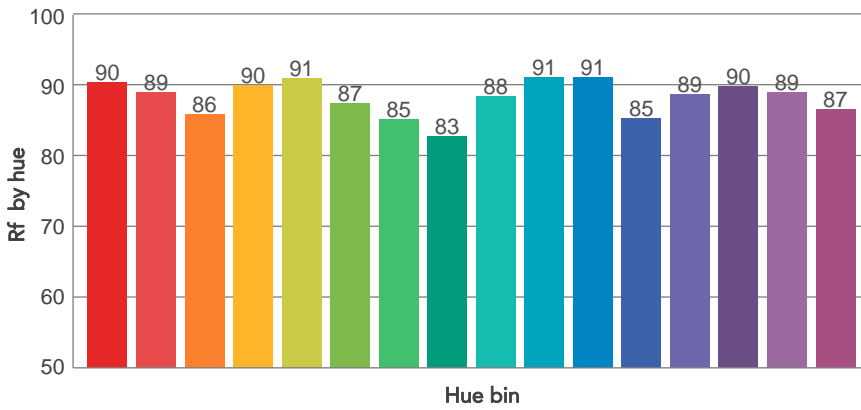
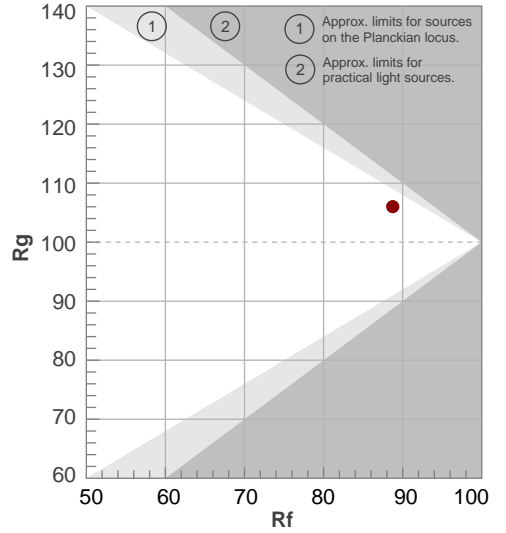

# BEAM DETAILS



Beam angle 50%	Field angle 10%	Cut off angle 2,5%	Intensity ratio in 120° cone	Intensity ratio in 90° cone
110,9°	161,2°	177°	76,4%	52,2%

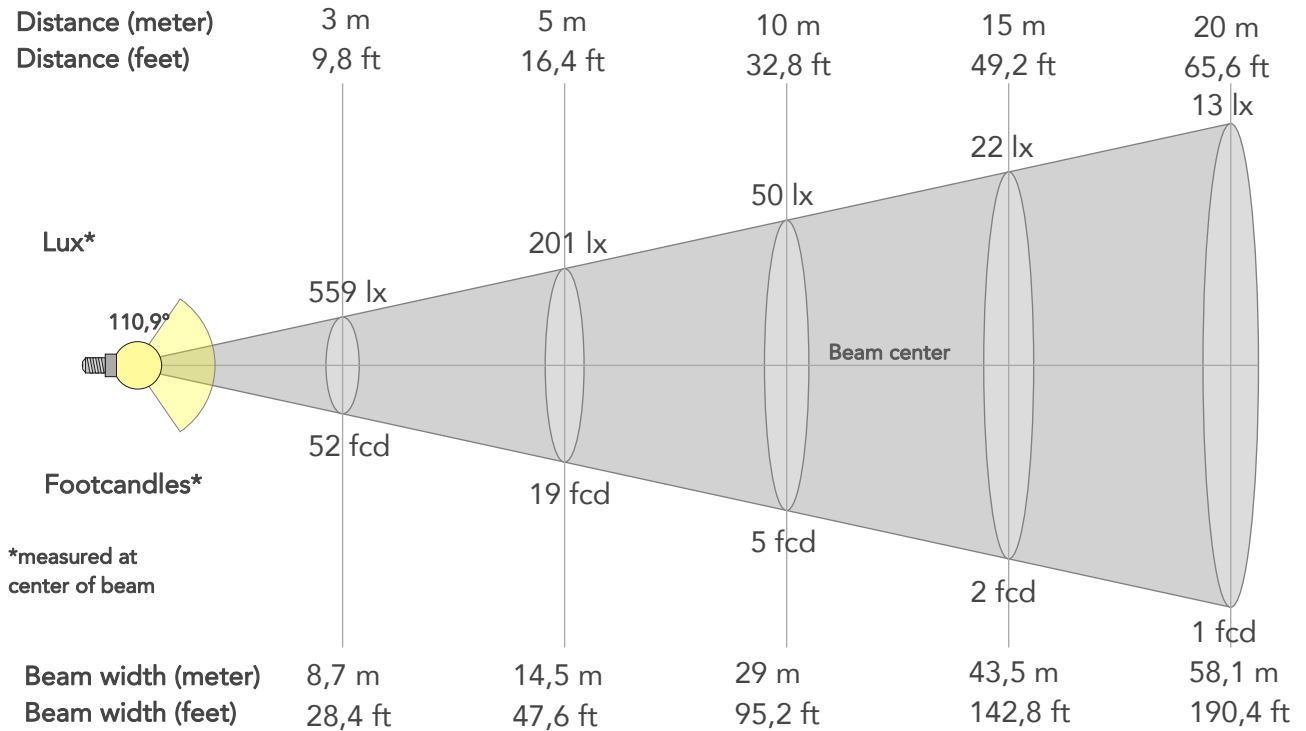

## BEAM INTENSITIES AND WIDTHS

Distance	1m	2m	3m	4m	5m	7,5m	10m	15m	20m	25m	30m	40m	50m
Distance	3,3ft	6,6ft	9,8ft	13,1ft	16,4ft	24,6ft	32,8ft	49,2ft	65,6ft	82ft	98,4ft	131,2ft	164ft
Lux	5035lx	1259lx	559lx	315lx	201lx	90lx	50lx	22lx	13lx	8lx	6lx	3lx	2lx
Footcand.	468fcd	117fcd	52fcd	29fcd	19fcd	8fcd	5fcd	2fcd	1fcd	1fcd	1fcd	0fcd	0fcd
Beam wid.	2,9m	5,8m	8,7m	11,6m	14,5m	21,8m	29m	43,5m	58,1m	72,6m	87,1m	116,1m	145,2m
Beam wid.	9,6ft	19,2ft	28,4ft	38ft	47,6ft	71,4ft	95,2ft	142,8ft	190,4ft	238ft	285,7ft	380,9ft	476,1ft

## LINEAR DISTRIBUTION DIAGRAM

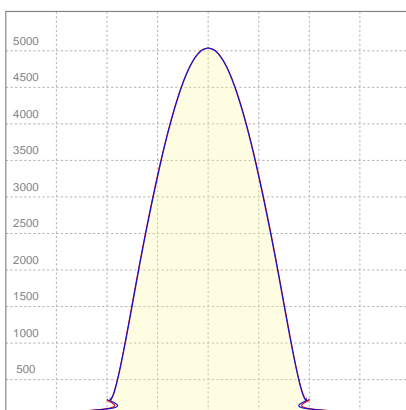

## ELECTRICAL SPECIFICATIONS

Input voltage	Input current	Input power	Effeciency
225V	1,03A	228,2W	64lm/W



## ISO CANDELA DIAGRAM

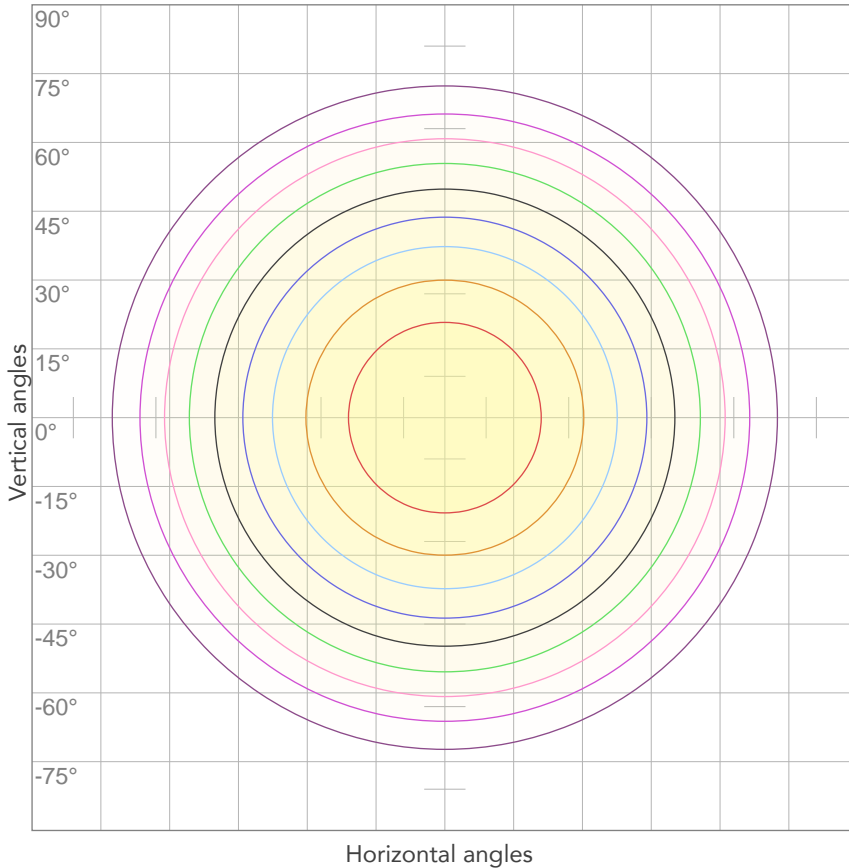

10%	503 cd
20%	1007 cd
30%	1510 cd
40%	2014 cd
50%	2517 cd
60%	3021 cd
70%	3524 cd
80%	4028 cd

Conditions:

Number of c-planes: 4

Candela at center: 5035 cd

## ISO LUX DIAGRAM

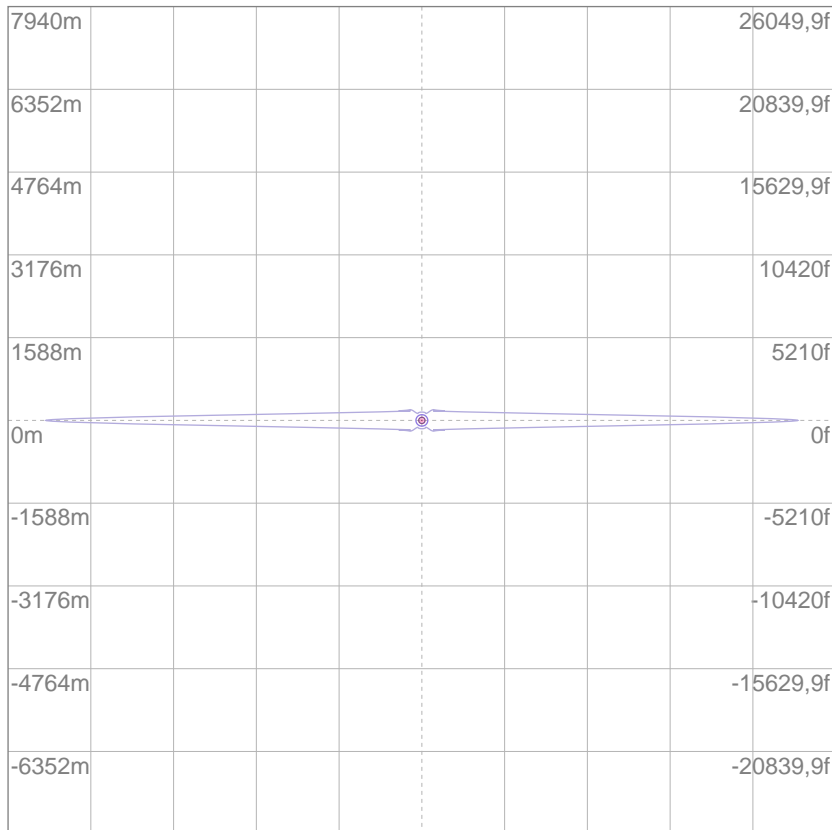

Mounting height: 10 meters (33 feet)

3%	1,51 lx
5%	2,52 lx
10%	5,03 lx
30%	15,1 lx
50%	25,2 lx

Conditions:

Number of c-planes: 4

Lux at center: 50,3 lx

*Lux distribution on a surface when lamp is mounted at 10 meters from the surface.*



Total lumen output:

17217 lm

Peak candela output:

6548 cd

Light quality:

CRI: 89,9

Color temperature:

3261 K

**PRODUCT NAME:**

ECLPANEL TWCJR

**MEASUREMENT CONDITIONS:**

Beam angle:

Filter MD

Target:

3200K

Operator:

Paolo Carvone

Date and time:

14/05/2020 16:05:53

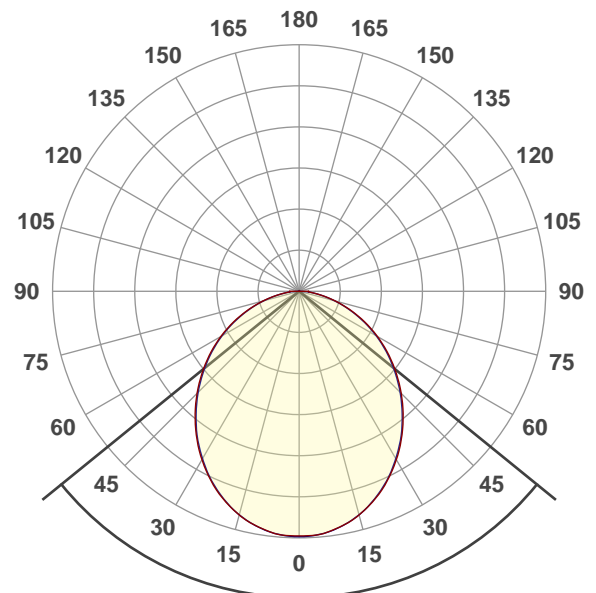

Spectra

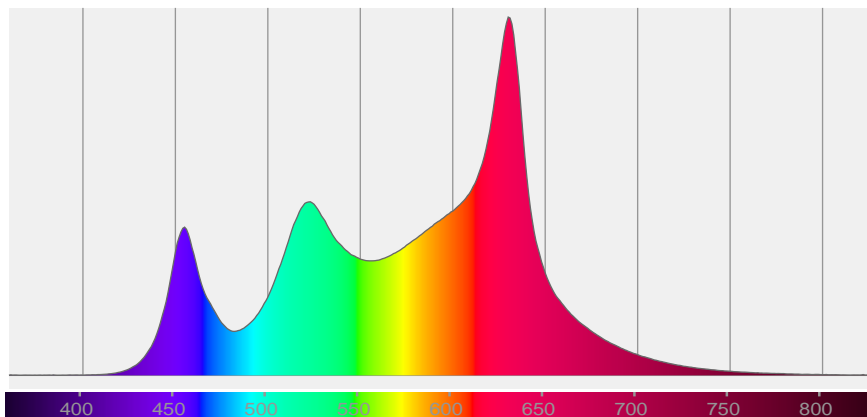

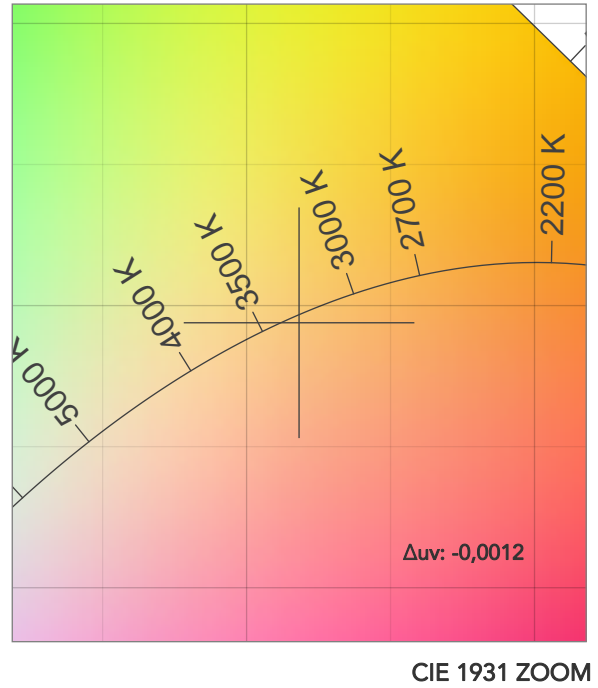
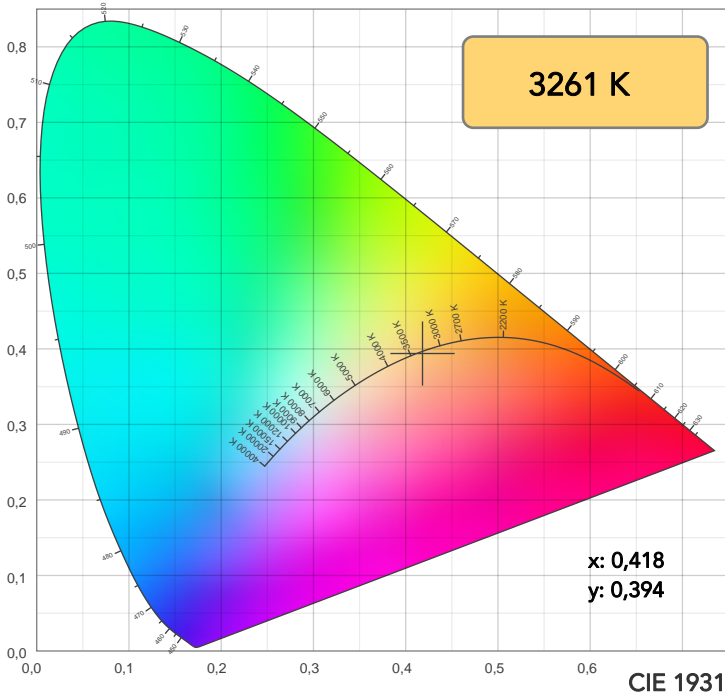

TM30: 89,8

CRI: 89,9 (R1-R8)

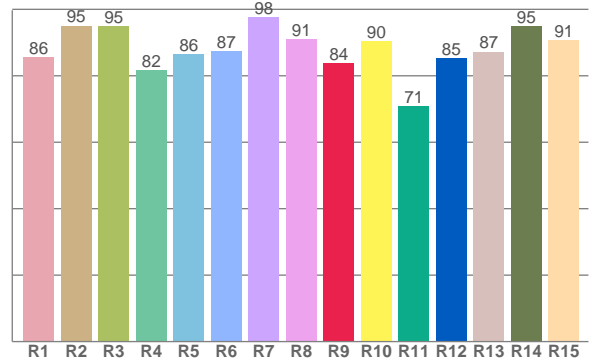
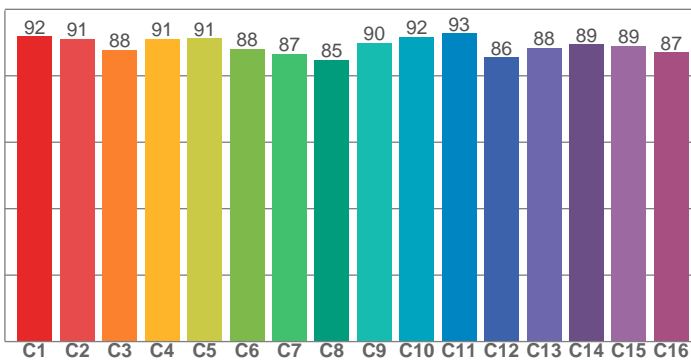

CRI R values, only R1-R8 are used to calculate final CRI value

R1	R2	R3	R4	R5	R6	R7	R8	R9	R10	R11	R12	R13	R14	R15
85,6	95,1	94,8	81,7	86,4	87,4	97,7	90,9	83,8	90,3	70,9	85,3	87,2	94,9	90,7

TM30 C values, 16 binned values out of total of 99 C values

C1	C2	C3	C4	C5	C6	C7	C8	C9	C10	C11	C12	C13	C14	C15	C16
91,9	91,1	87,9	91,1	91,2	88,1	86,6	84,8	90,0	91,7	92,8	85,5	88,4	89,4	89,0	87,0

CQS Q values

Q1	Q2	Q3	Q4	Q5	Q6	Q7	Q8	Q9	Q10	Q11	Q12	Q13	Q14	Q15
93,9	95,2	96,6	92,3	89,8	89,5	96,1	94,3	96,0	96,4	89,0	88,4	90,7	93,6	93,8

CQS: 92,4

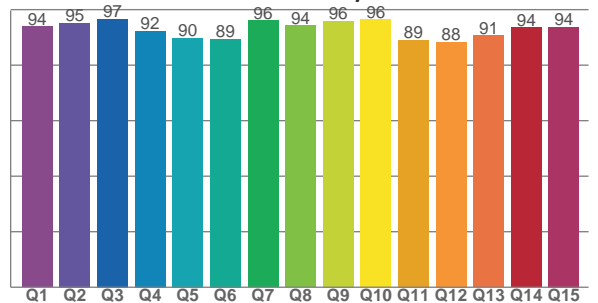

COLOR PARAMETERS

Color temperature	Color rendering index	Red component	Color fidelity	Color gamut	Color quality scale	Television lighting index	Color coordinate cie 1931	Color coordinate cie 1931	Color deviation from black body
CCT	CRI	CRI R9	TM30 Rf	TM30 Rg	CQS	TLCI	x	y	Δuv
3261 K	89,9	83,8	89,8	105,0	92,4	83	0,418	0,394	-0,0012

# TM30 DETAILS

**Rf 89,8**  
Fidelity index Rf

**Rg 105,0**  
Gammut index

Hue Bin	R <sub>f</sub>	Graphic shifts (%)	
		Chroma	Hue
1	92	2%	0%
2	91	3%	-3%
3	88	2%	-4%
4	91	-2%	-4%
5	91	-4%	1%
6	88	4%	6%
7	87	3%	5%
8	85	9%	0%
9	90	6%	1%
10	92	3%	-1%
11	93	3%	0%
12	86	6%	-6%
13	88	1%	-8%
14	89	2%	-5%
15	89	2%	-1%
16	87	4%	-6%

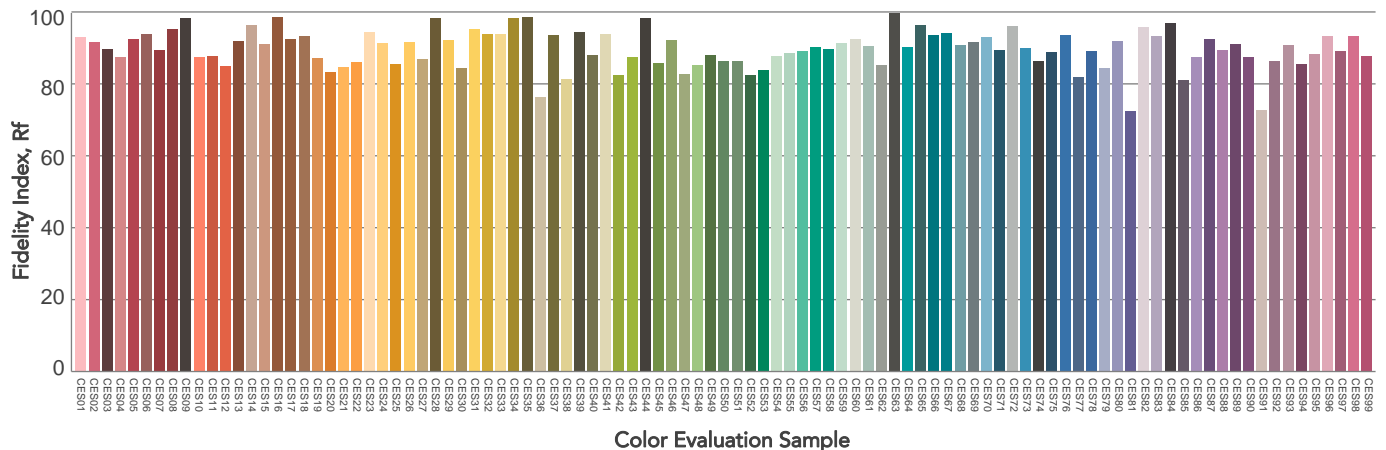
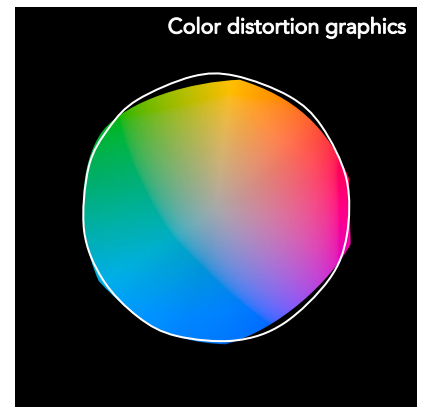
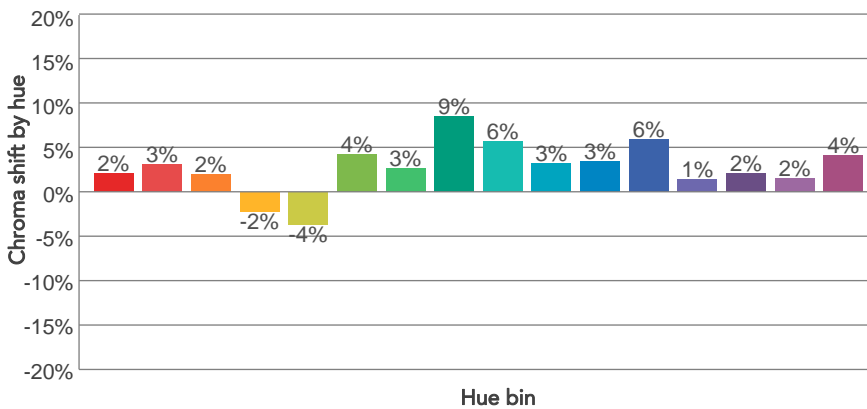
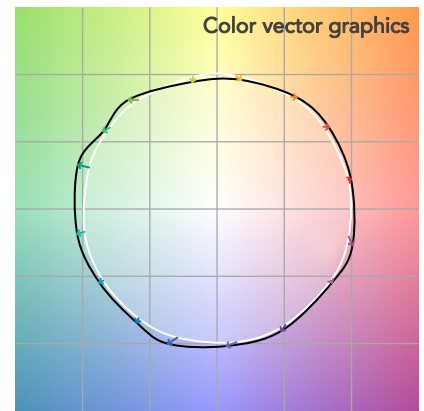
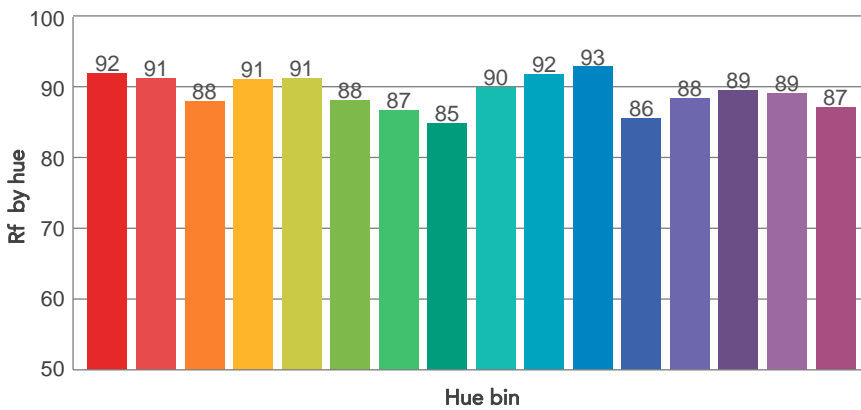
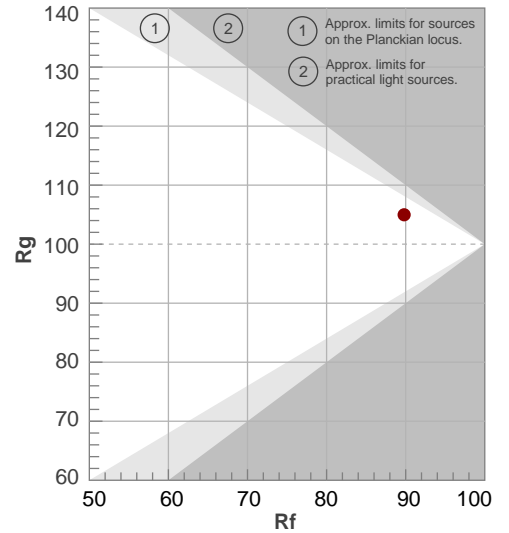

# BEAM DETAILS



Beam angle 50%	Field angle 10%	Cut off angle 2,5%	Intensity ratio in 120° cone	Intensity ratio in 90° cone
101,8°	158,2°	176,8°	77,9%	54,6%

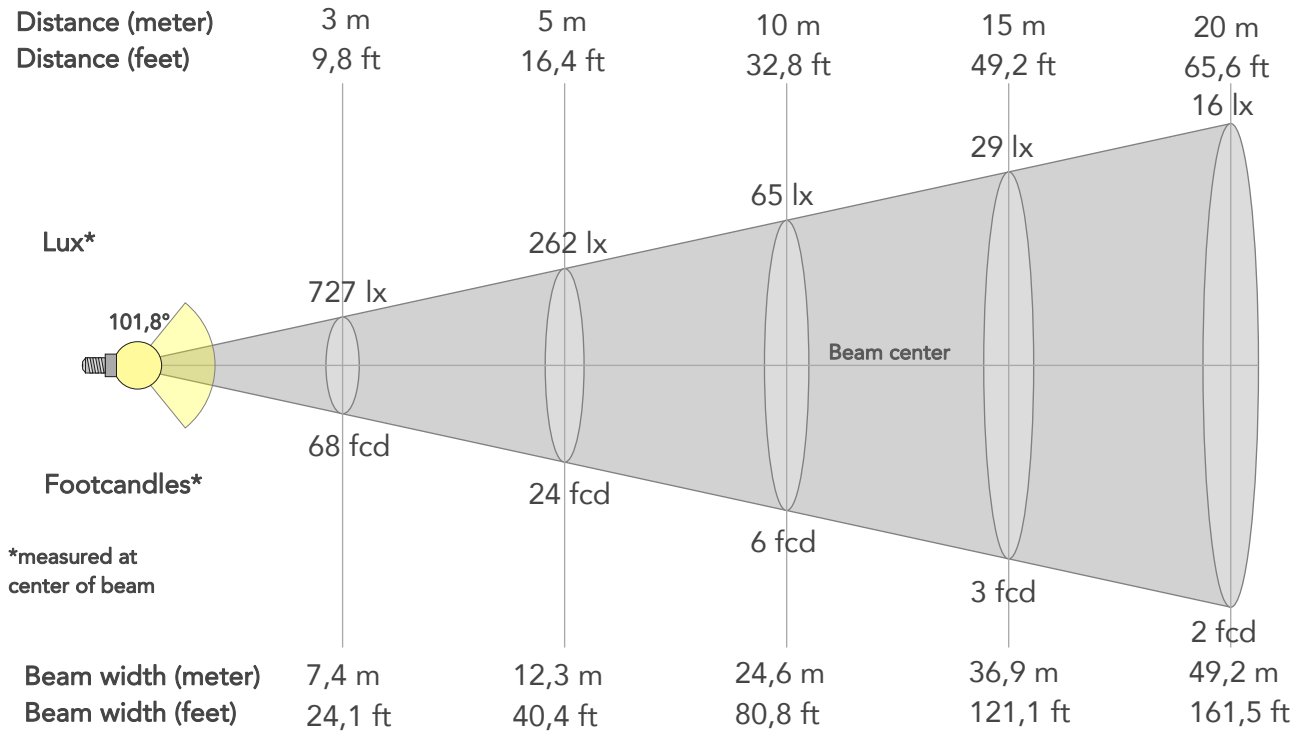

## BEAM INTENSITIES AND WIDTHS

Distance	1m	2m	3m	4m	5m	7,5m	10m	15m	20m	25m	30m	40m	50m
Distance	3,3ft	6,6ft	9,8ft	13,1ft	16,4ft	24,6ft	32,8ft	49,2ft	65,6ft	82ft	98,4ft	131,2ft	164ft
Lux	6539lx	1635lx	727lx	409lx	262lx	116lx	65lx	29lx	16lx	10lx	7lx	4lx	3lx
Footcand.	608fcd	152fcd	68fcd	38fcd	24fcd	11fcd	6fcd	3fcd	2fcd	1fcd	1fcd	0fcd	0fcd
Beam wid.	2,5m	4,9m	7,4m	9,8m	12,3m	18,5m	24,6m	36,9m	49,2m	61,6m	73,9m	98,5m	123,1m
Beam wid.	8,1ft	16,3ft	24,1ft	32,3ft	40,4ft	60,6ft	80,8ft	121,1ft	161,5ft	201,9ft	242,3ft	323,1ft	403,8ft

## LINEAR DISTRIBUTION DIAGRAM

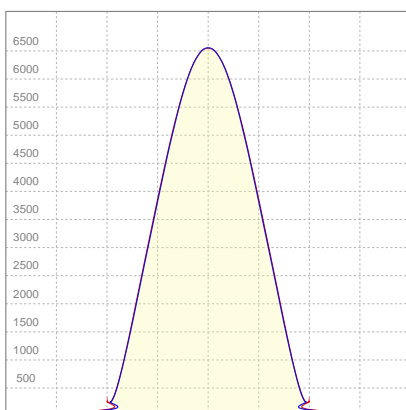

## ELECTRICAL SPECIFICATIONS

Input voltage	Input current	Input power	Effeciency
224V	1,04A	228,3W	75lm/W

## ISO CANDELA DIAGRAM

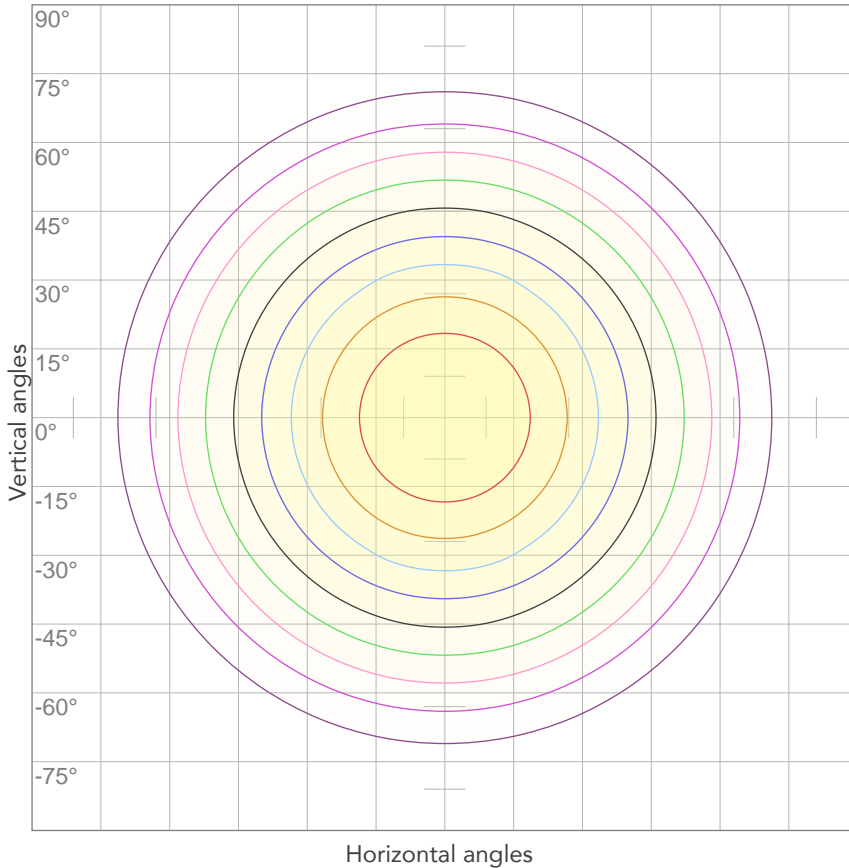

10%	654 cd
20%	1308 cd
30%	1962 cd
40%	2616 cd
50%	3270 cd
60%	3924 cd
70%	4577 cd
80%	5231 cd

**Conditions:**

Number of c-planes: 4

Candela at center: 6539 cd

## ISO LUX DIAGRAM

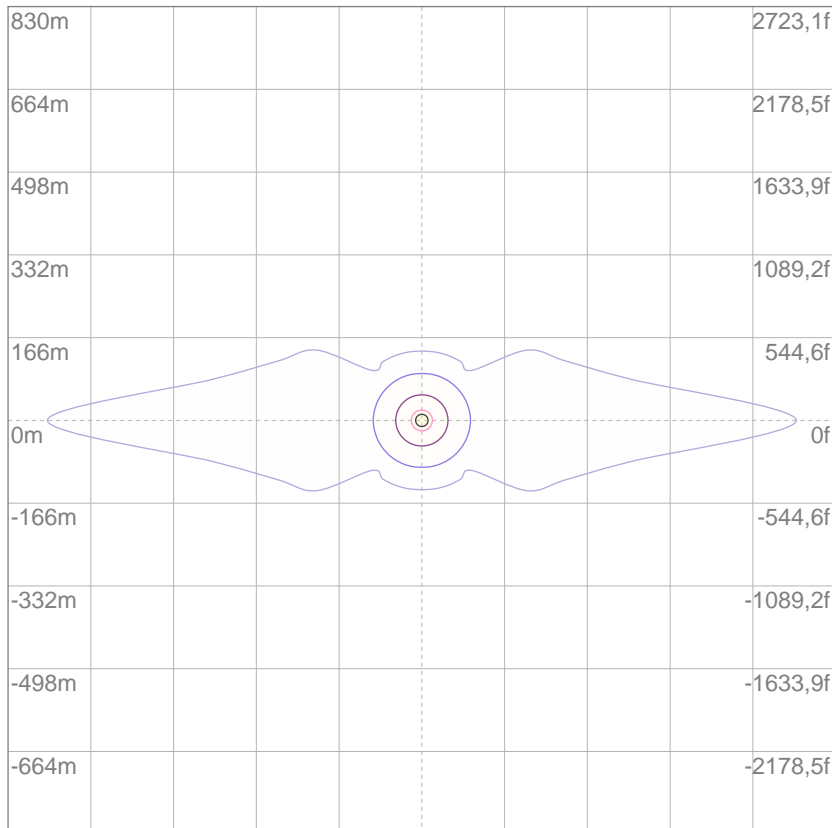

3%	1,96 lx
5%	3,27 lx
10%	6,54 lx
30%	19,6 lx
50%	32,7 lx

**Conditions:**

Number of c-planes: 4

Lux at center: 65,4 lx

*Lux distribution on a surface when lamp is mounted at 10 meters from the surface.*

Mounting height: 10 meters (33 feet)



Total lumen output:

17254 lm

Peak candela output:

6690 cd

Light quality:

CRI: 90,0

Color temperature:

3277 K

**PRODUCT NAME:**

ECLPANEL TWCJR

**MEASUREMENT CONDITIONS:**

Beam angle:

Filter LD

Target:

3200K

Operator:

Paolo Carvone

Date and time:

14/05/2020 15:49:56

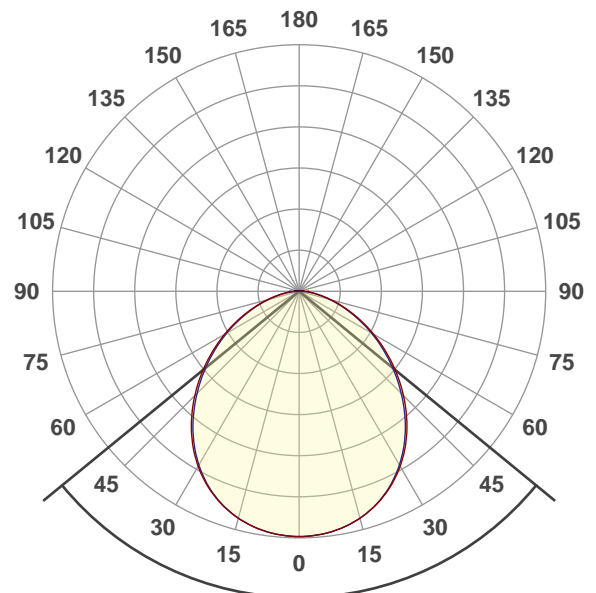

Beam angle 50%: 101,4°

Field angle 10%: 155,9°

Cut off angle 2.5%: 175,8°

Spectra

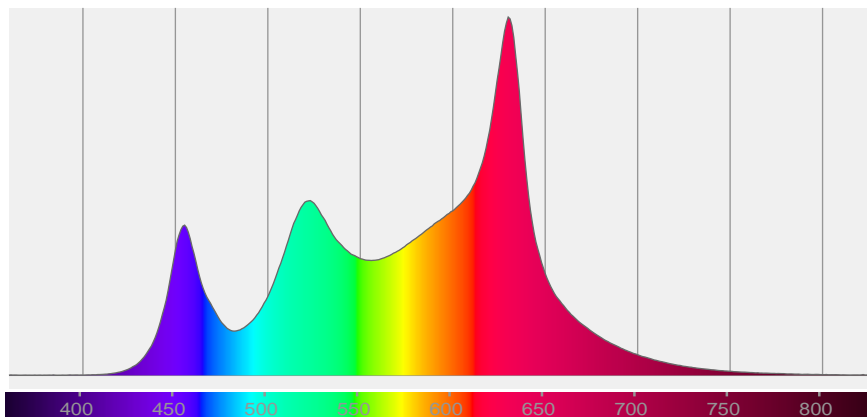

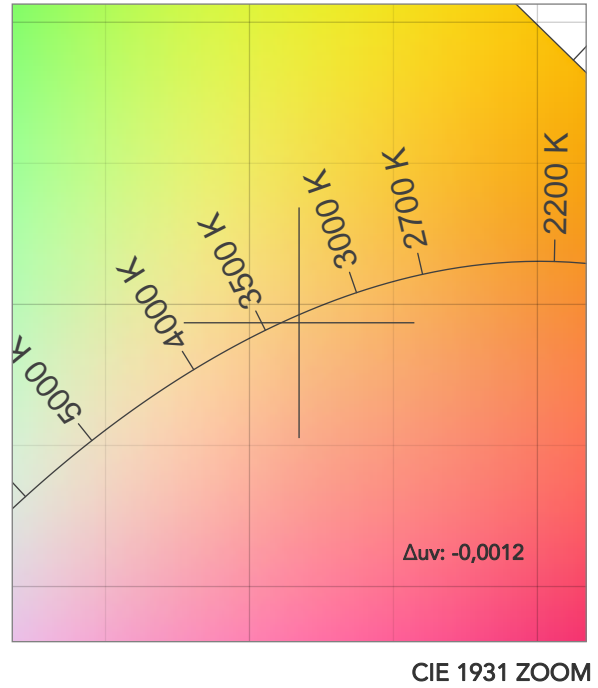
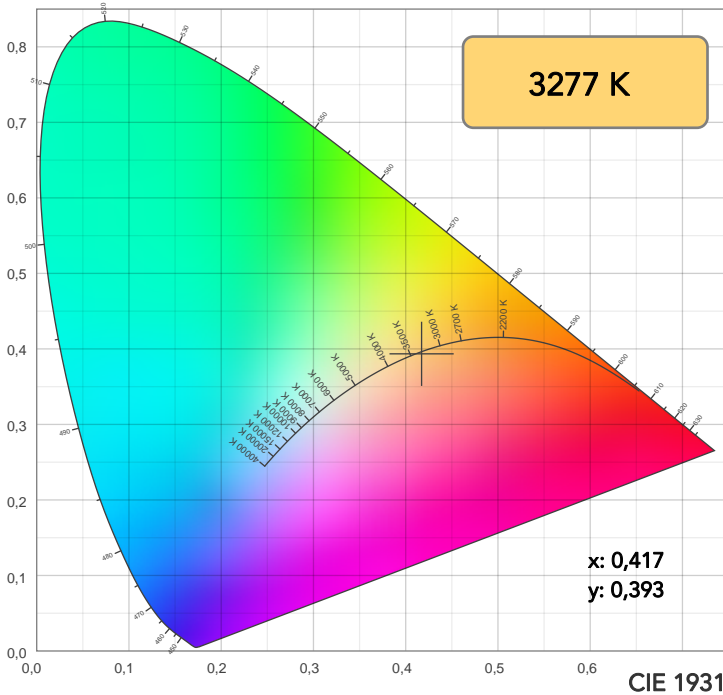

TM30: 89,8

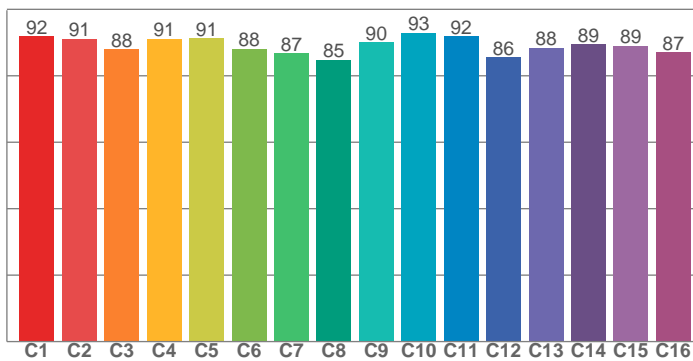

CRI: 90,0 (R1-R8)

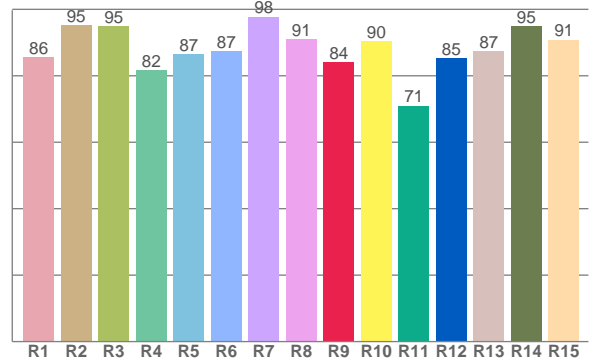

CRI R values, only R1-R8 are used to calculate final CRI value

R1	R2	R3	R4	R5	R6	R7	R8	R9	R10	R11	R12	R13	R14	R15
85,7	95,1	94,8	81,7	86,5	87,5	97,8	91,1	84,1	90,4	71,0	85,3	87,3	94,9	90,8

TM30 C values, 16 binned values out of total of 99 C values

C1	C2	C3	C4	C5	C6	C7	C8	C9	C10	C11	C12	C13	C14	C15	C16
91,9	91,2	87,9	91,2	91,3	88,1	86,7	84,8	90,0	92,9	91,8	85,6	88,4	89,4	89,0	87,0

CQS Q values

Q1	Q2	Q3	Q4	Q5	Q6	Q7	Q8	Q9	Q10	Q11	Q12	Q13	Q14	Q15
93,9	95,2	96,6	92,4	89,8	89,5	96,2	94,3	96,0	96,5	89,1	88,4	90,8	93,6	93,9

CQS: 92,5

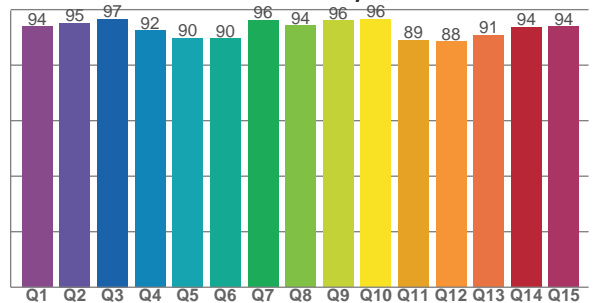

COLOR PARAMETERS

Color temperature	Color rendering index	Red component	Color fidelity	Color gamut	Color quality scale	Television lighting index	Color coordinate cie 1931	Color coordinate cie 1931	Color deviation from black body
CCT	CRI	CRI R9	TM30 Rf	TM30 Rg	CQS	TLCI	x	y	Δuv
3277 K	90,0	84,1	89,8	104,9	92,5	83	0,417	0,393	-0,0012



# TM30 DETAILS

**Rf 89,8**  
Fidelity index Rf

**Rg 104,9**  
Gammut index

Hue Bin	R <sub>f</sub>	Graphic shifts (%)	
		Chroma	Hue
1	92	2%	0%
2	91	3%	-3%
3	88	2%	-4%
4	91	-2%	-4%
5	91	-4%	1%
6	88	4%	6%
7	87	3%	5%
8	85	9%	0%
9	90	6%	1%
10	93	3%	-1%
11	92	4%	1%
12	86	6%	-6%
13	88	1%	-8%
14	89	2%	-5%
15	89	2%	-1%
16	87	4%	-6%

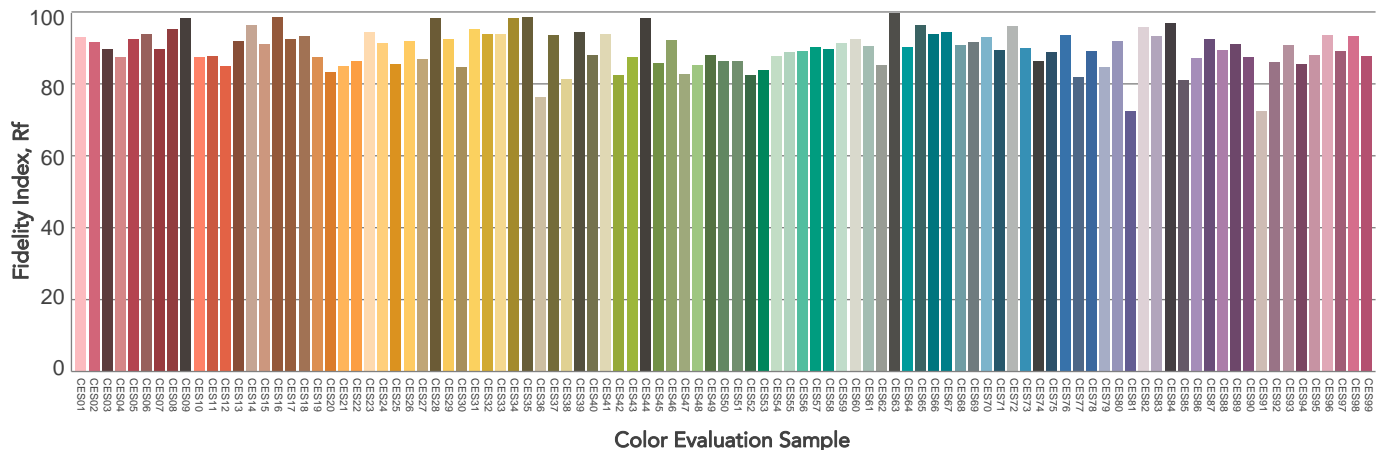
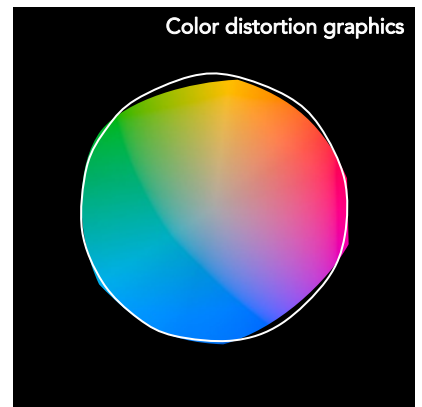
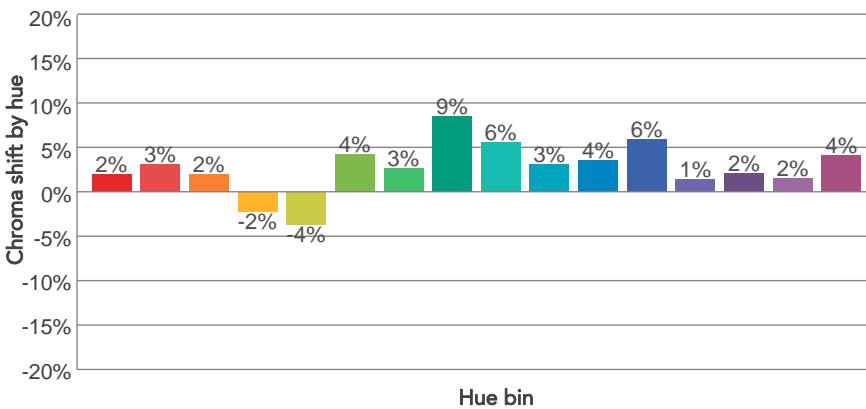
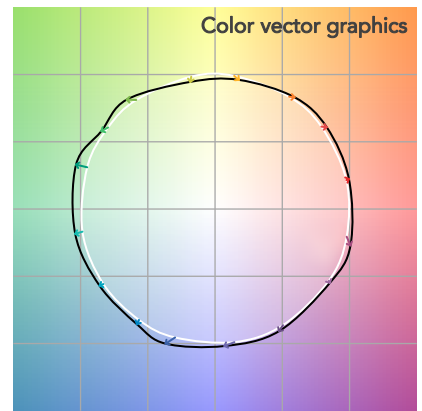
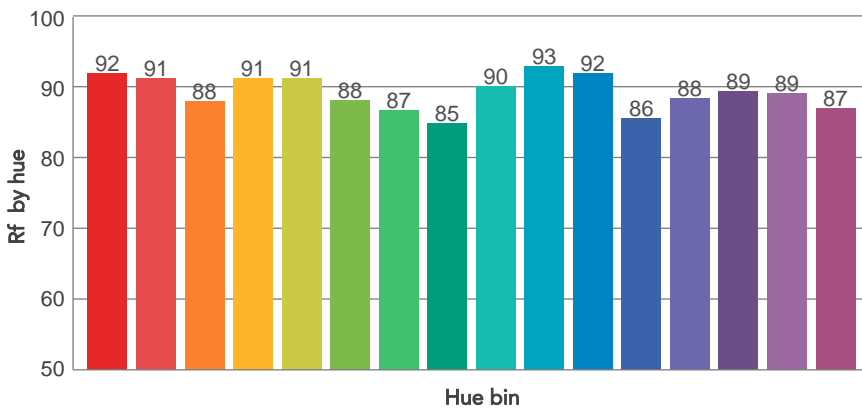
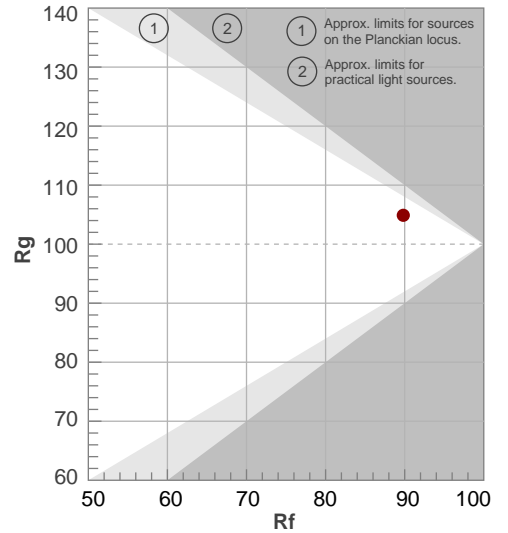

# BEAM DETAILS



Beam angle 50%	Field angle 10%	Cut off angle 2,5%	Intensity ratio in 120° cone	Intensity ratio in 90° cone
101,4°	155,9°	175,8°	80,7%	57,3%

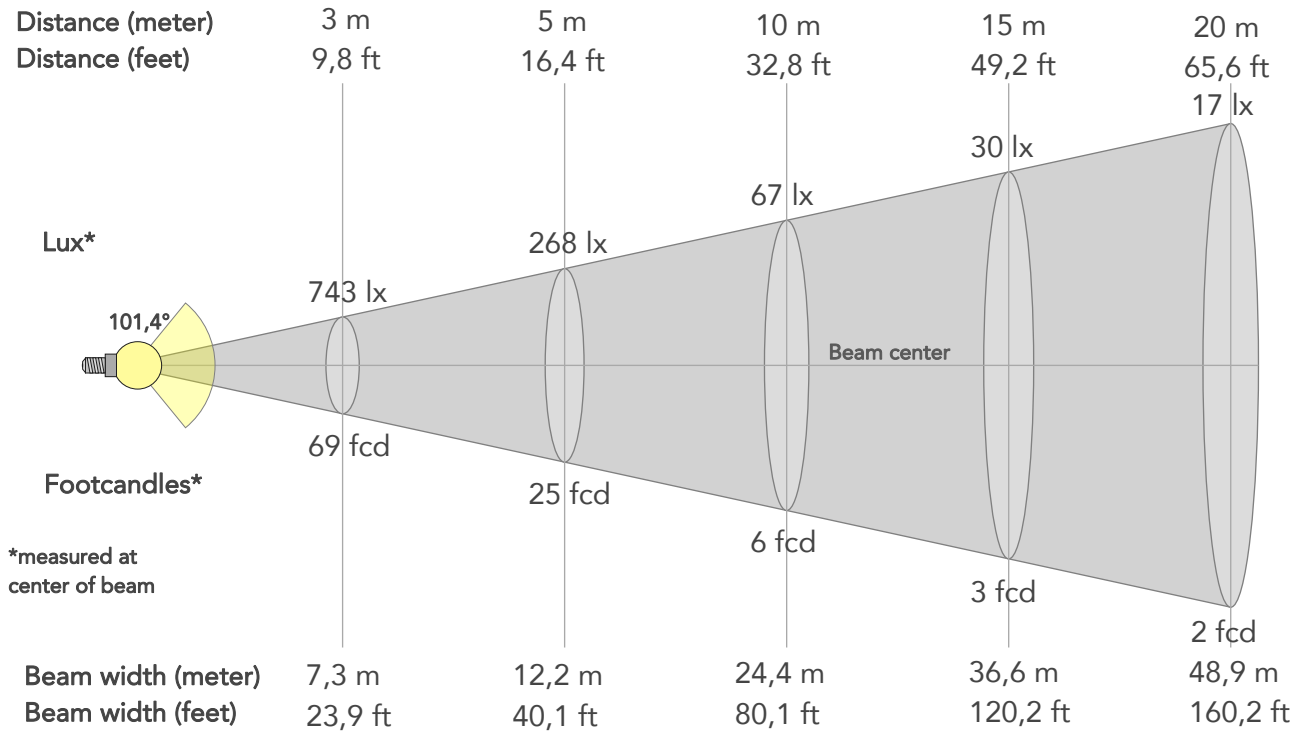

## BEAM INTENSITIES AND WIDTHS

Distance	1m	2m	3m	4m	5m	7,5m	10m	15m	20m	25m	30m	40m	50m
Distance	3,3ft	6,6ft	9,8ft	13,1ft	16,4ft	24,6ft	32,8ft	49,2ft	65,6ft	82ft	98,4ft	131,2ft	164ft
Lux	6690lx	1673lx	743lx	418lx	268lx	119lx	67lx	30lx	17lx	11lx	7lx	4lx	3lx
Footcand.	622fcd	155fcd	69fcd	39fcd	25fcd	11fcd	6fcd	3fcd	2fcd	1fcd	1fcd	0fcd	0fcd
Beam wid.	2,4m	4,9m	7,3m	9,8m	12,2m	18,3m	24,4m	36,6m	48,9m	61,1m	73,3m	97,7m	122,1m
Beam wid.	8,1ft	16,1ft	23,9ft	32ft	40,1ft	60,1ft	80,1ft	120,2ft	160,2ft	200,3ft	240,4ft	320,5ft	400,6ft

## LINEAR DISTRIBUTION DIAGRAM

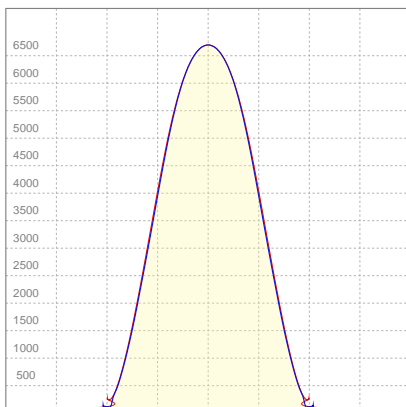

## ELECTRICAL SPECIFICATIONS

Input voltage	Input current	Input power	Effeciency
224V	1,03A	227,7W	76lm/W

## ISO CANDELA DIAGRAM

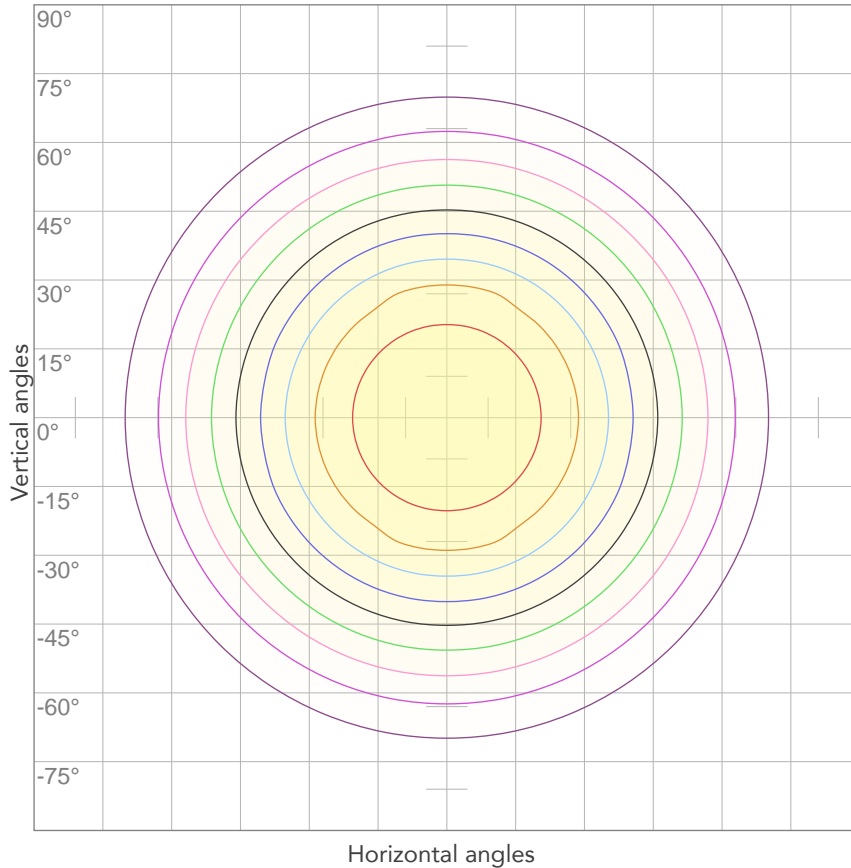

10%	669 cd
20%	1338 cd
30%	2007 cd
40%	2676 cd
50%	3345 cd
60%	4014 cd
70%	4683 cd
80%	5352 cd

Conditions:

Number of c-planes: 4

Candela at center: 6690 cd

## ISO LUX DIAGRAM

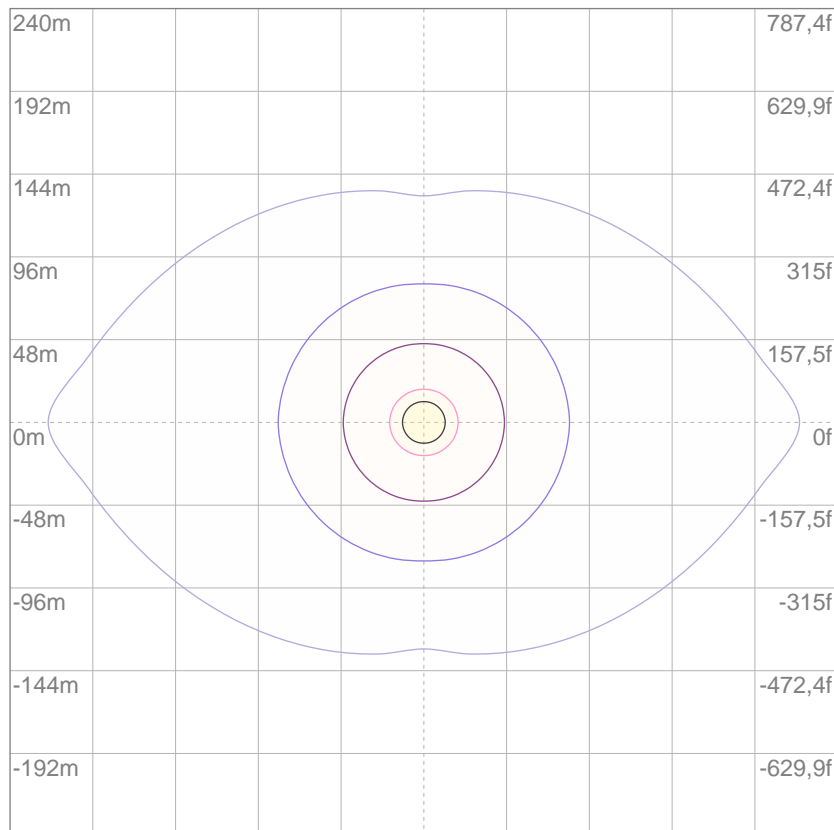

3%	2,01 lx
5%	3,35 lx
10%	6,69 lx
30%	20,1 lx
50%	33,5 lx

Conditions:

Number of c-planes: 4

Lux at center: 66,9 lx

*Lux distribution on a surface when lamp is mounted at 10 meters from the surface.*

Mounting height: 10 meters (33 feet)



Total lumen output:

14927 lm

Peak candela output:

9803 cd

Light quality:

CRI: 92,0

Color temperature:

3157 K

**PRODUCT NAME:**

**ECLPANEL TWCJR**

**MEASURAMENT CONDITIONS:**

Beam angle:

Filter INT

Target:

3200K

Operator:

Paolo Carvone

Date and time:

13/11/2020 12:12:01

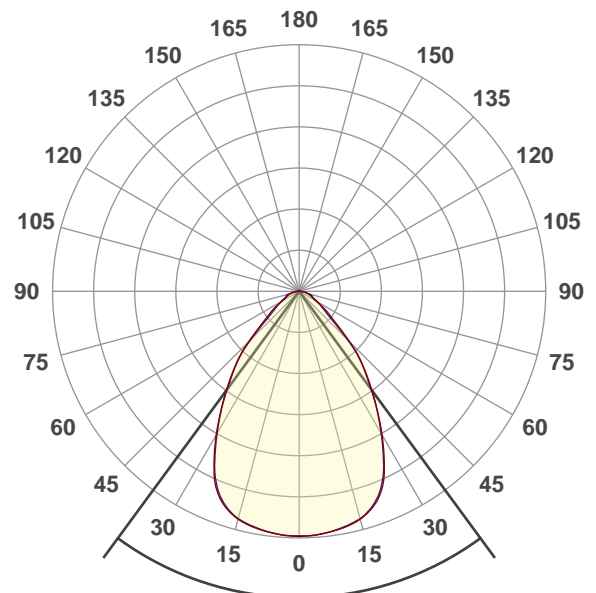

Beam angle 50%: 72,6°

Field angle 10%: 115,3°

Cut off angle 2.5%: 160,7°

Spectra

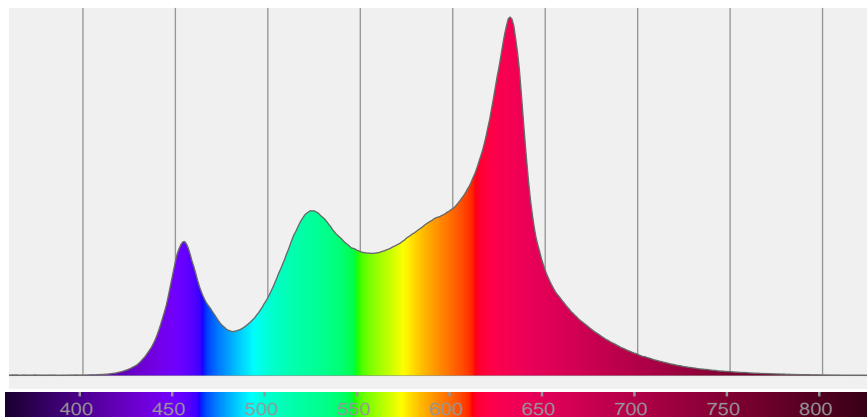

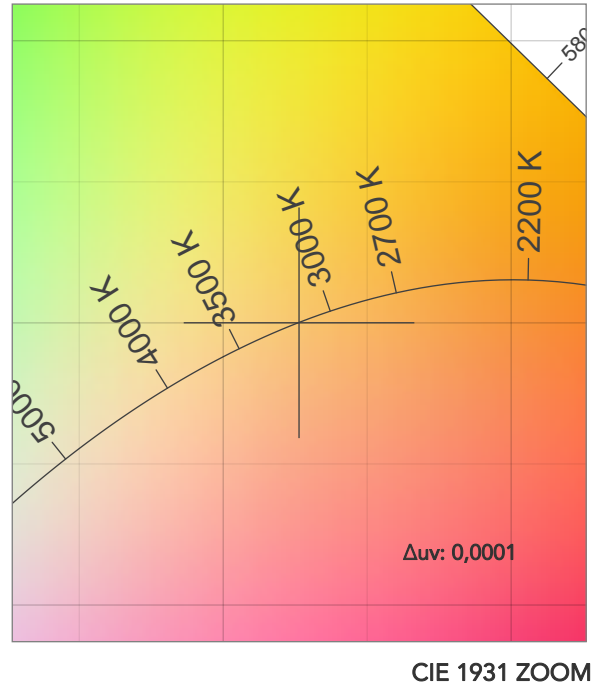
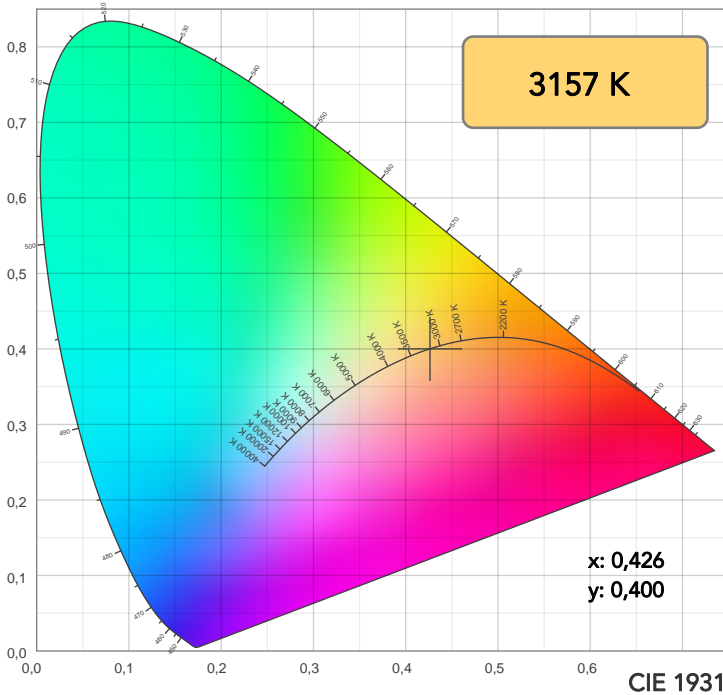

TM30: 90,9

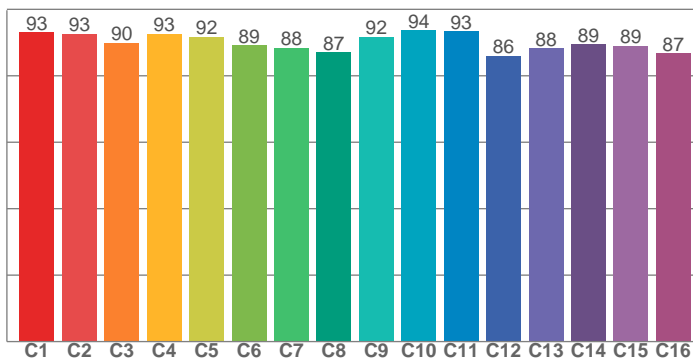

CRI: 92,0 (R1-R8)

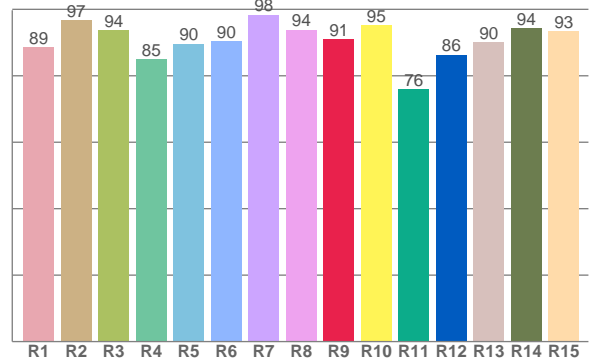

CRI R values, only R1-R8 are used to calculate final CRI value

R1	R2	R3	R4	R5	R6	R7	R8	R9	R10	R11	R12	R13	R14	R15
88,6	96,8	93,7	84,9	89,7	90,4	98,3	93,8	91,1	95,1	75,9	86,3	90,1	94,3	93,5

TM30 C values, 16 binned values out of total of 99 C values

C1	C2	C3	C4	C5	C6	C7	C8	C9	C10	C11	C12	C13	C14	C15	C16
93,1	92,5	90,0	92,7	91,7	89,2	88,4	87,1	91,7	93,6	93,3	86,0	88,3	89,4	88,9	86,7

CQS Q values

Q1	Q2	Q3	Q4	Q5	Q6	Q7	Q8	Q9	Q10	Q11	Q12	Q13	Q14	Q15
93,7	94,7	95,6	94,3	91,4	90,3	95,5	95,0	95,6	96,9	90,6	89,6	91,3	94,2	94,6

CQS: 93,1

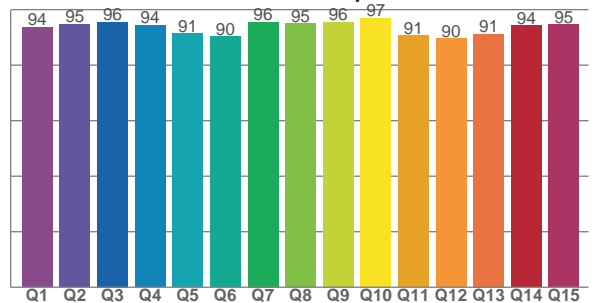

COLOR PARAMETERS

Color temperature	Color rendering index	Red component	Color fidelity	Color gamut	Color quality scale	Television lighting index	Color coordinate cie 1931	Color coordinate cie 1931	Color deviation from black body
CCT	CRI	CRI R9	TM30 Rf	TM30 Rg	CQS	TLCI	x	y	Δuv
3157 K	92,0	91,1	90,9	104,1	93,1	87	0,426	0,400	0,0001

# TM30 DETAILS

**Rf 90,9**  
Fidelity index Rf

**Rg 104,1**  
Gammut index

Hue Bin	R <sub>f</sub>	Graphic shifts (%)	
		Chroma	Hue
1	93	1%	0%
2	93	2%	-2%
3	90	1%	-3%
4	93	-2%	-3%
5	92	-3%	2%
6	89	4%	5%
7	88	2%	4%
8	87	7%	0%
9	92	4%	1%
10	94	2%	0%
11	93	3%	2%
12	86	6%	-6%
13	88	2%	-8%
14	89	2%	-5%
15	89	1%	-1%
16	87	3%	-8%

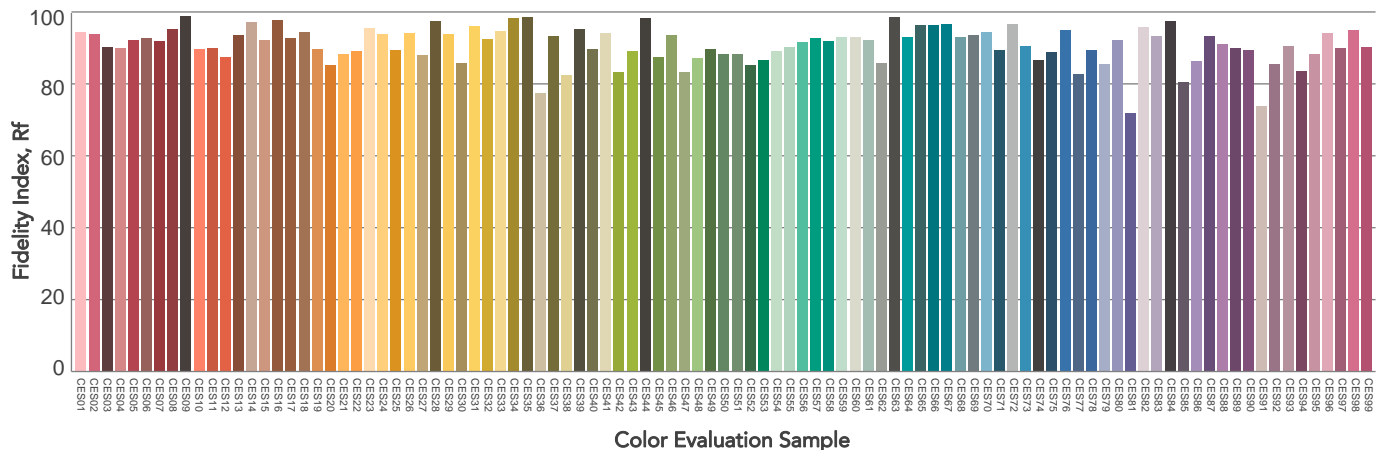
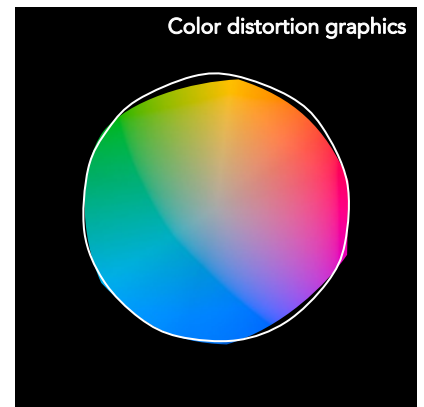
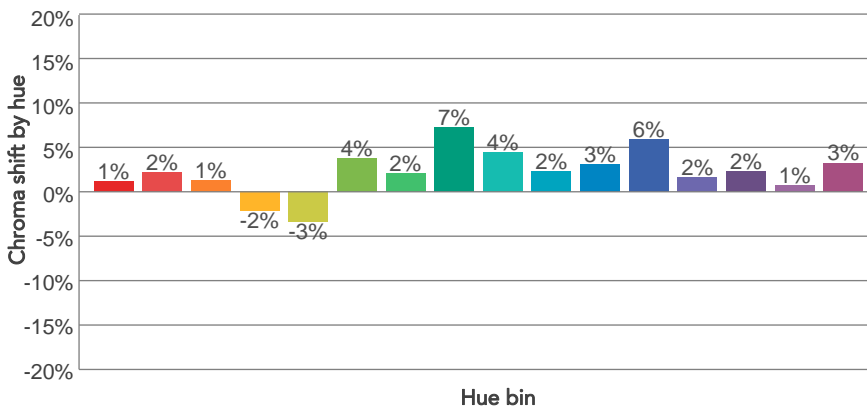
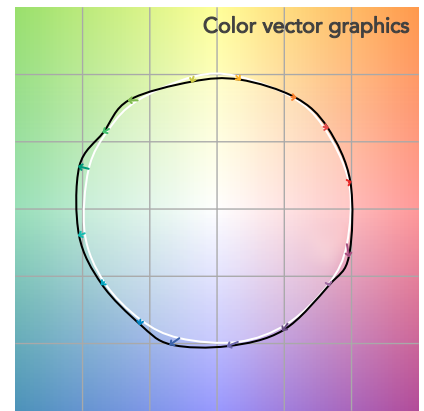
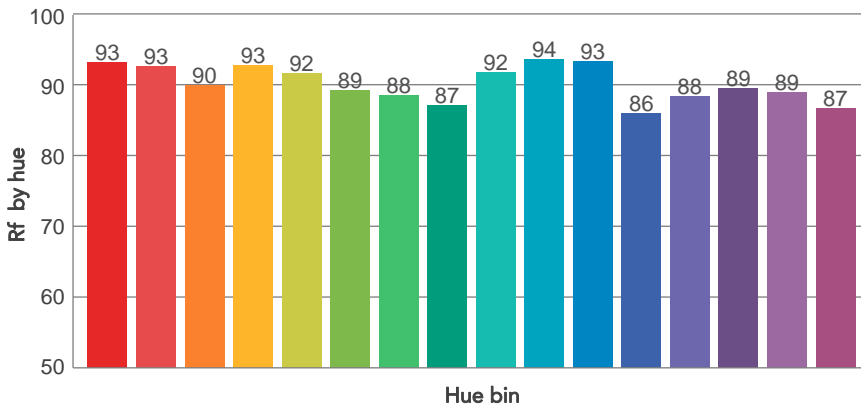
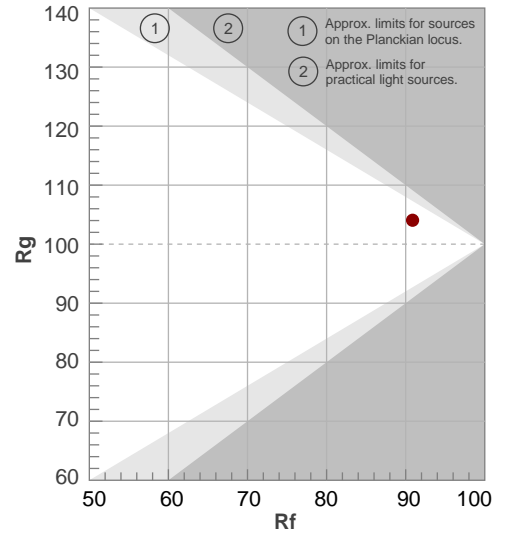

# BEAM DETAILS



Beam angle 50%	Field angle 10%	Cut off angle 2,5%	Intensity ratio in 120° cone	Intensity ratio in 90° cone
72,6°	115,3°	160,7°	91,9%	78,8%

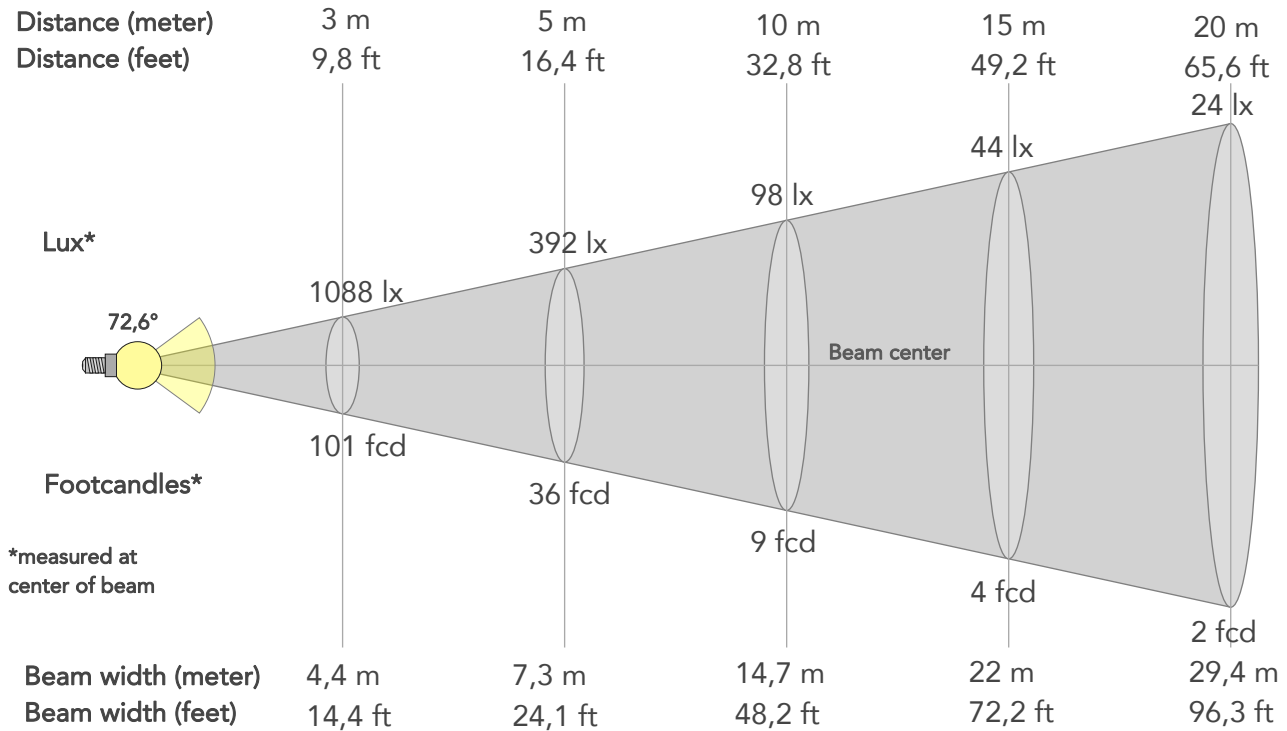

## BEAM INTENSITIES AND WIDTHS

Distance	1m	2m	3m	4m	5m	7,5m	10m	15m	20m	25m	30m	40m	50m
Distance	3,3ft	6,6ft	9,8ft	13,1ft	16,4ft	24,6ft	32,8ft	49,2ft	65,6ft	82ft	98,4ft	131,2ft	164ft
Lux	9793lx	2448lx	1088lx	612lx	392lx	174lx	98lx	44lx	24lx	16lx	11lx	6lx	4lx
Footcand.	910fcd	227fcd	101fcd	57fcd	36fcd	16fcd	9fcd	4fcd	2fcd	1fcd	1fcd	1fcd	0fcd
Beam wid.	1,5m	2,9m	4,4m	5,9m	7,3m	11m	14,7m	22m	29,4m	36,7m	44,1m	58,7m	73,4m
Beam wid.	4,8ft	9,7ft	14,4ft	19,2ft	24,1ft	36,1ft	48,2ft	72,2ft	96,3ft	120,4ft	144,5ft	192,7ft	240,8ft

## LINEAR DISTRIBUTION DIAGRAM

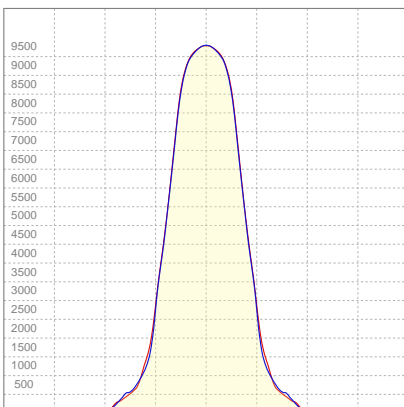

## ELECTRICAL SPECIFICATIONS

Input voltage	Input current	Input power	Effeciency
226V	1,06A	229,5W	65lm/W

## ISO CANDELA DIAGRAM

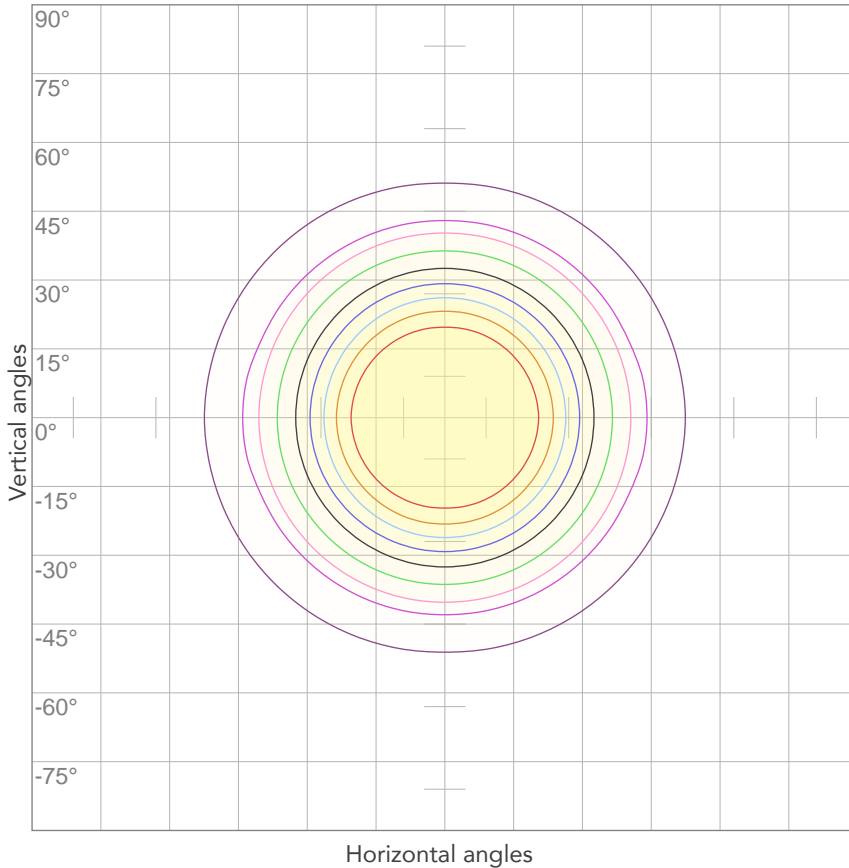

10%	979 cd
20%	1959 cd
30%	2938 cd
40%	3917 cd
50%	4897 cd
60%	5876 cd
70%	6855 cd
80%	7835 cd

**Conditions:**

Number of c-planes: 4

Candela at center: 9793 cd

## ISO LUX DIAGRAM

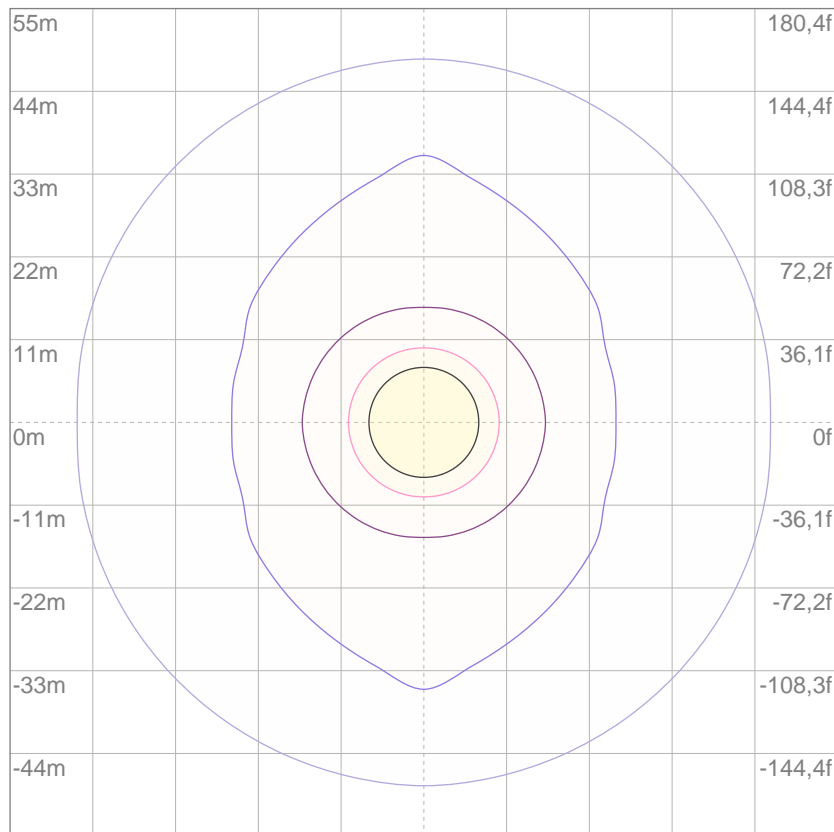

3%	2,94 lx
5%	4,90 lx
10%	9,79 lx
30%	29,4 lx
50%	49,0 lx

**Conditions:**

Number of c-planes: 4

Lux at center: 97,9 lx

*Lux distribution on a surface when lamp is mounted at 10 meters from the surface.*

Mounting height: 10 meters (33 feet)





Total lumen output:

14486 lm

Peak candela output:

4990 cd

Light quality:

CRI: 89,6

Color temperature:

4190 K

**PRODUCT NAME:**

ECLPANEL TWCJR

**MEASUREMENT CONDITIONS:**

Beam angle:

Filter HD

Target:

4000K

Operator:

Paolo Carvone

Date and time:

14/05/2020 16:24:34

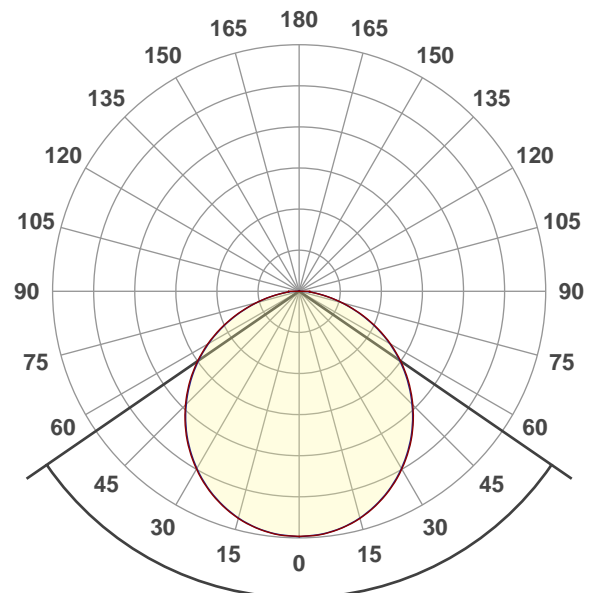

Beam angle 50%: 111°

Field angle 10%: 161,3°

Cut off angle 2.5%: 177°

Spectra

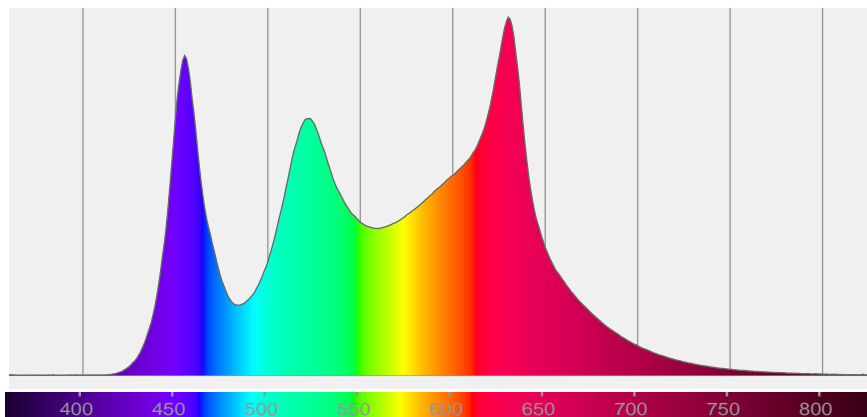

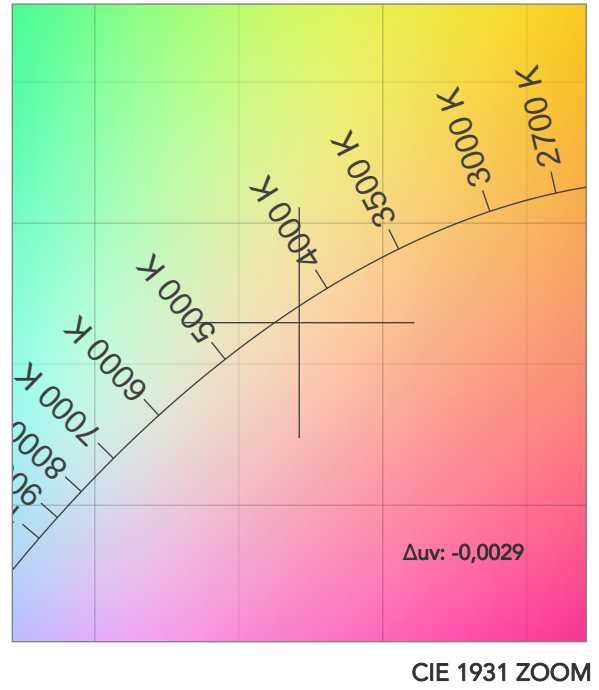
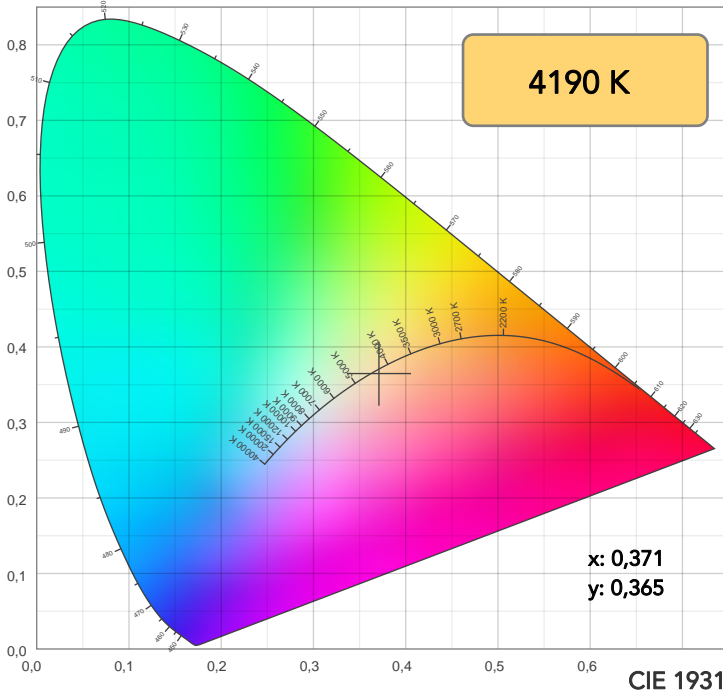

TM30: 88,9

CRI: 89,6 (R1-R8)

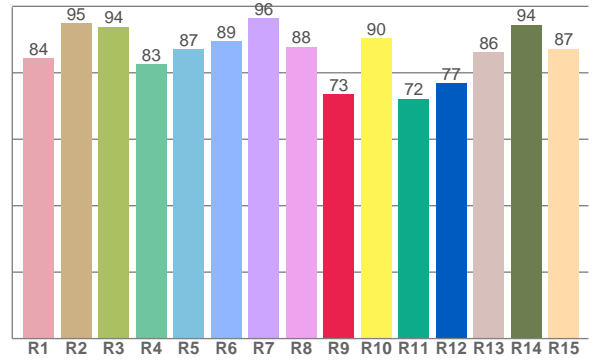
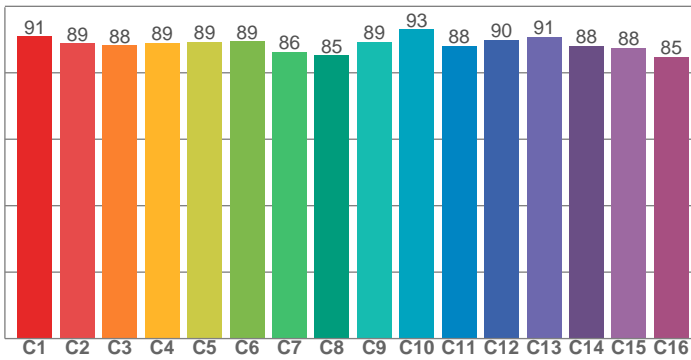

CRI R values, only R1-R8 are used to calculate final CRI value

R1	R2	R3	R4	R5	R6	R7	R8	R9	R10	R11	R12	R13	R14	R15
84,5	94,9	93,8	82,6	87,2	89,4	96,4	87,8	73,5	90,4	72,2	76,9	86,3	94,4	87,3

TM30 C values, 16 binned values out of total of 99 C values

C1	C2	C3	C4	C5	C6	C7	C8	C9	C10	C11	C12	C13	C14	C15	C16
91,0	88,9	88,3	88,9	89,3	89,4	86,2	85,3	89,3	93,1	88,1	89,9	90,7	88,0	87,5	84,7

CQS Q values

Q1	Q2	Q3	Q4	Q5	Q6	Q7	Q8	Q9	Q10	Q11	Q12	Q13	Q14	Q15
93,1	98,1	93,2	97,8	94,7	93,8	98,0	94,7	95,5	98,7	90,6	89,5	91,7	94,2	93,2

CQS: 93,8

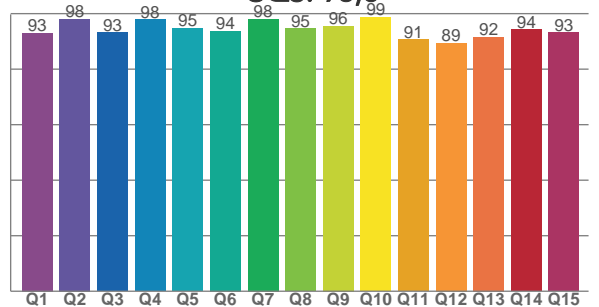

COLOR PARAMETERS

Color temperature	Color rendering index	Red component	Color fidelity	Color gamut	Color quality scale	Television lighting index	Color coordinate cie 1931	Color coordinate cie 1931	Color deviation from black body
CCT	CRI	CRI R9	TM30 Rf	TM30 Rg	CQS	TLCI	x	y	Δuv
4190 K	89,6	73,5	88,9	104,9	93,8	86	0,371	0,365	-0,0029

# TM30 DETAILS

**Rf 88,9**  
Fidelity index Rf

**Rg 104,9**  
Gammut index

Hue Bin	R <sub>f</sub>	Graphic shifts (%)	
		Chroma	Hue
1	91	3%	0%
2	89	4%	-3%
3	88	2%	-4%
4	89	-3%	-5%
5	89	-5%	0%
6	89	3%	5%
7	86	4%	5%
8	85	5%	4%
9	89	5%	5%
10	93	2%	2%
11	88	5%	4%
12	90	4%	-1%
13	91	3%	-4%
14	88	1%	5%
15	88	4%	-1%
16	85	5%	-4%

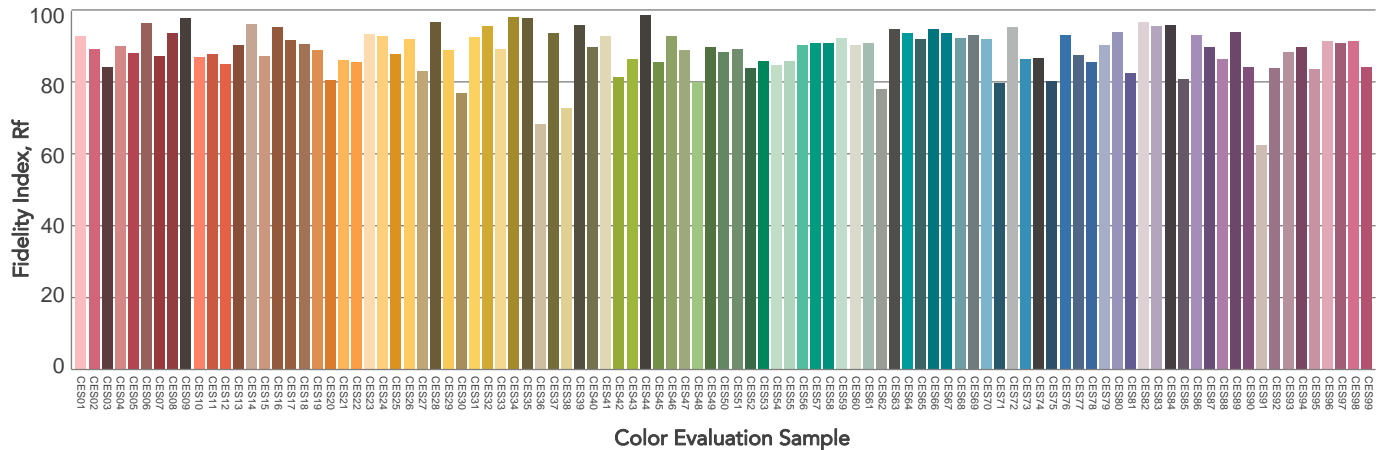
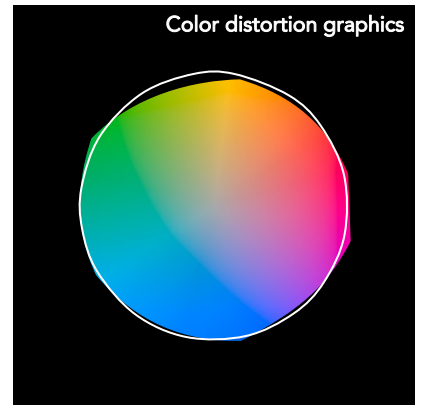
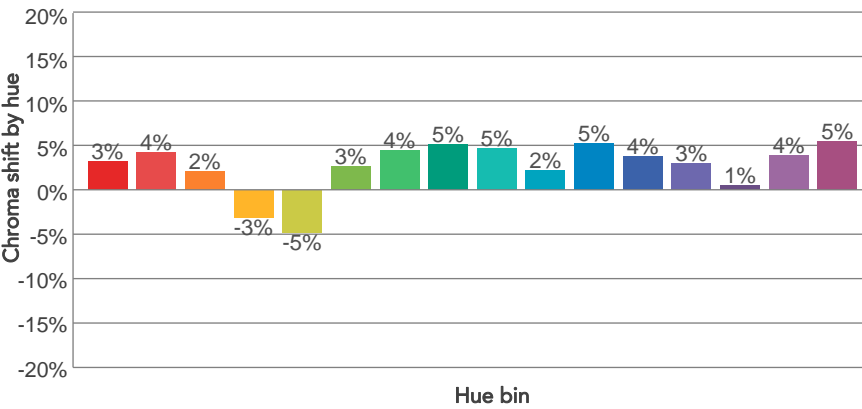
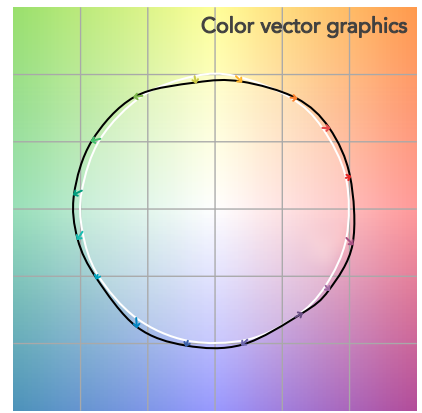
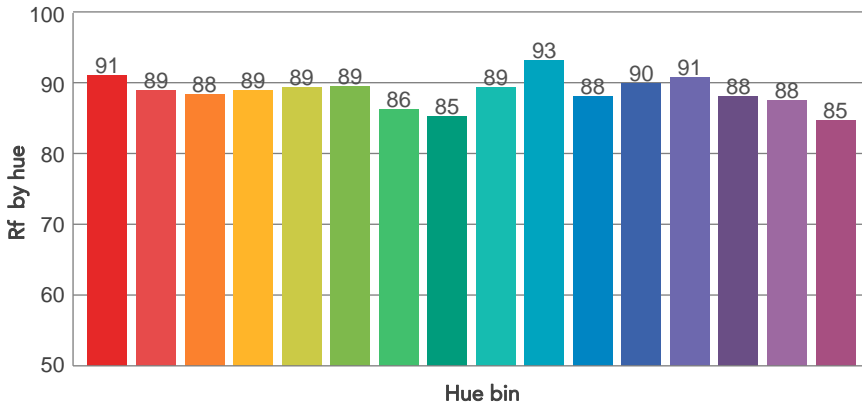
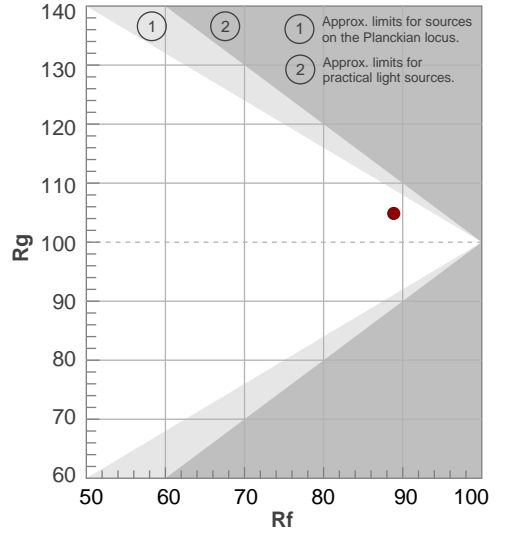

# BEAM DETAILS



Beam angle 50%	Field angle 10%	Cut off angle 2,5%	Intensity ratio in 120° cone	Intensity ratio in 90° cone
111°	161,3°	177°	76,4%	52,2%

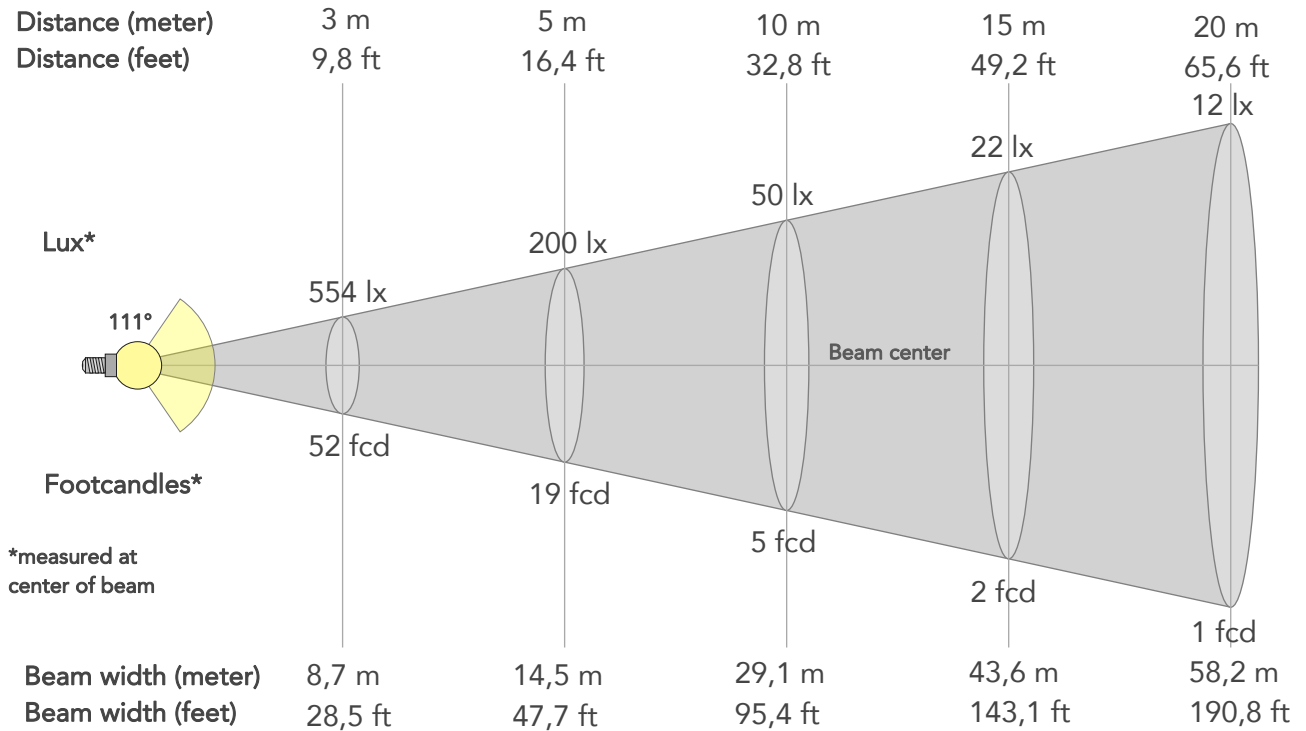

## BEAM INTENSITIES AND WIDTHS

Distance	1m	2m	3m	4m	5m	7,5m	10m	15m	20m	25m	30m	40m	50m
Distance	3,3ft	6,6ft	9,8ft	13,1ft	16,4ft	24,6ft	32,8ft	49,2ft	65,6ft	82ft	98,4ft	131,2ft	164ft
Lux	4990lx	1248lx	554lx	312lx	200lx	89lx	50lx	22lx	12lx	8lx	6lx	3lx	2lx
Footcand.	464fcd	116fcd	52fcd	29fcd	19fcd	8fcd	5fcd	2fcd	1fcd	1fcd	1fcd	0fcd	0fcd
Beam wid.	2,9m	5,8m	8,7m	11,6m	14,5m	21,8m	29,1m	43,6m	58,2m	72,7m	87,3m	116,3m	145,4m
Beam wid.	9,6ft	19,2ft	28,5ft	38,1ft	47,7ft	71,6ft	95,4ft	143,1ft	190,8ft	238,5ft	286,2ft	381,6ft	477ft

## LINEAR DISTRIBUTION DIAGRAM

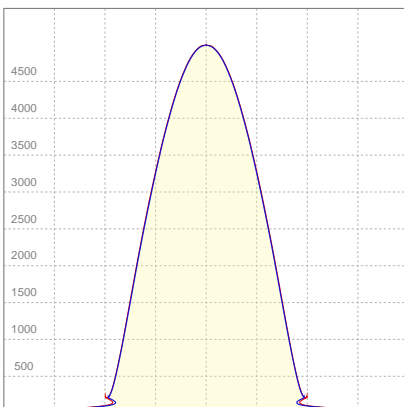

## ELECTRICAL SPECIFICATIONS

Input voltage	Input current	Input power	Effeciency
226V	1,02A	226,3W	64lm/W

## ISO CANDELA DIAGRAM

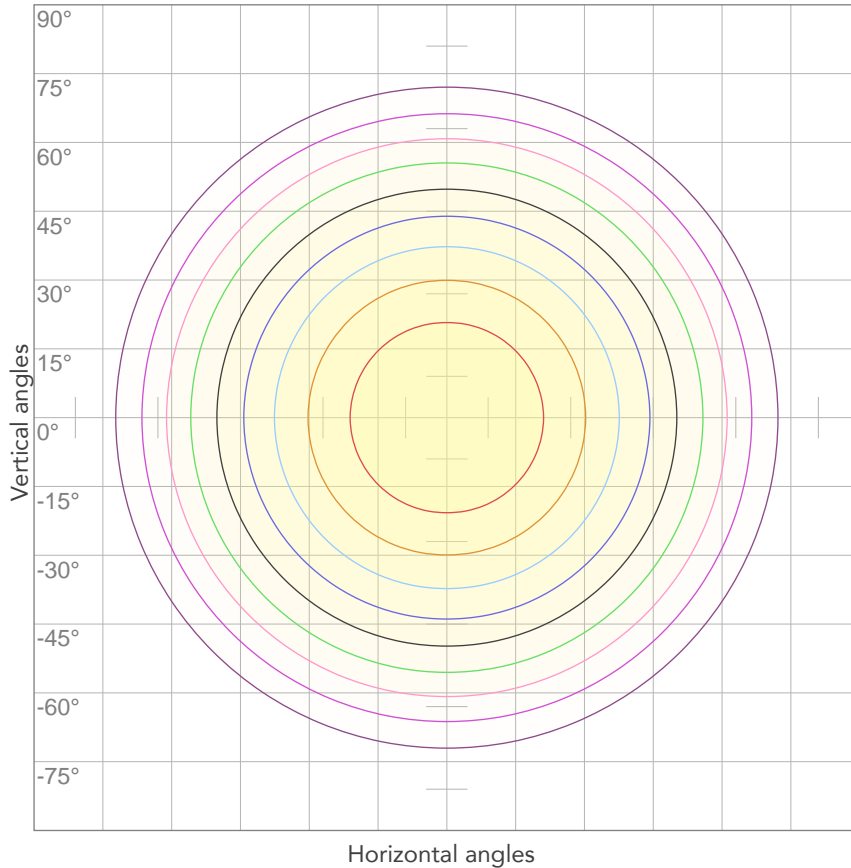

10%	499 cd
20%	998 cd
30%	1497 cd
40%	1996 cd
50%	2495 cd
60%	2994 cd
70%	3493 cd
80%	3992 cd

Conditions:

Number of c-planes: 4

Candela at center: 4990 cd

## ISO LUX DIAGRAM

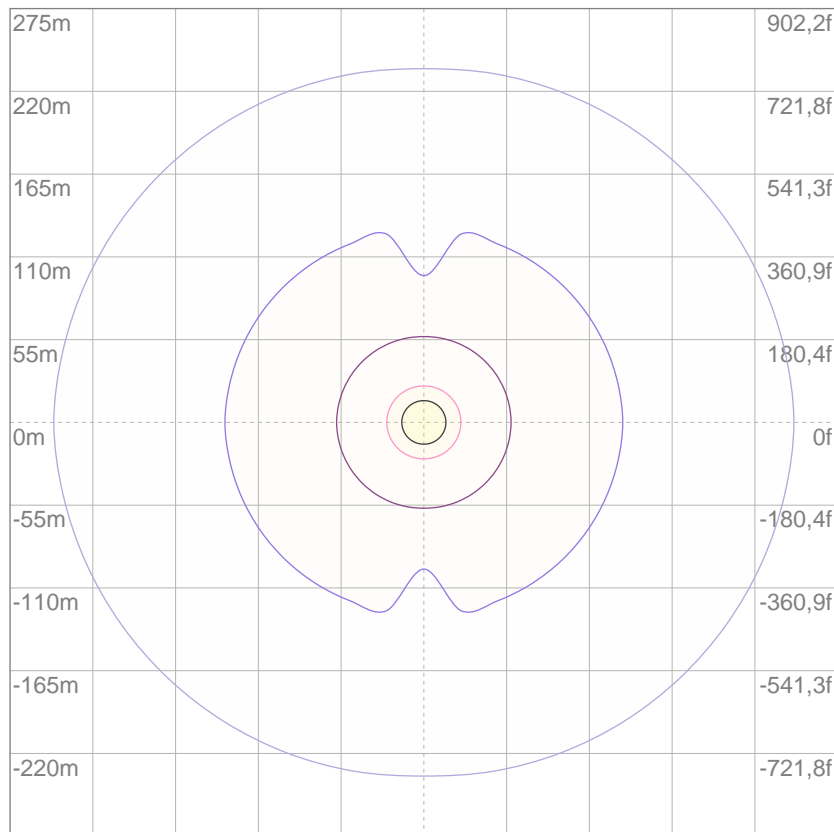

3%	1,50 lx
5%	2,50 lx
10%	4,99 lx
30%	15,0 lx
50%	25,0 lx

Conditions:

Number of c-planes: 4

Lux at center: 49,9 lx

*Lux distribution on a surface when lamp is mounted at 10 meters from the surface.*

Mounting height: 10 meters (33 feet)



Total lumen output:

16849 lm

Peak candela output:

6489 cd

Light quality:

CRI: 92,0

Color temperature:

4092 K

**PRODUCT NAME:**

**ECLPANEL TWCJR**

**MEASUREMENT CONDITIONS:**

Beam angle:

Filter MD

Target:

4000K

Operator:

Paolo Carvone

Date and time:

14/05/2020 16:07:43

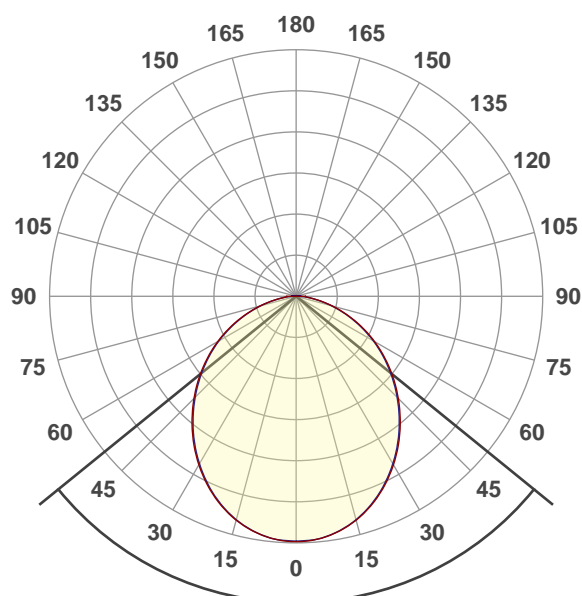

Beam angle 50%: 101,9°

Field angle 10%: 158,2°

Cut off angle 2.5%: 177,2°

Spectra

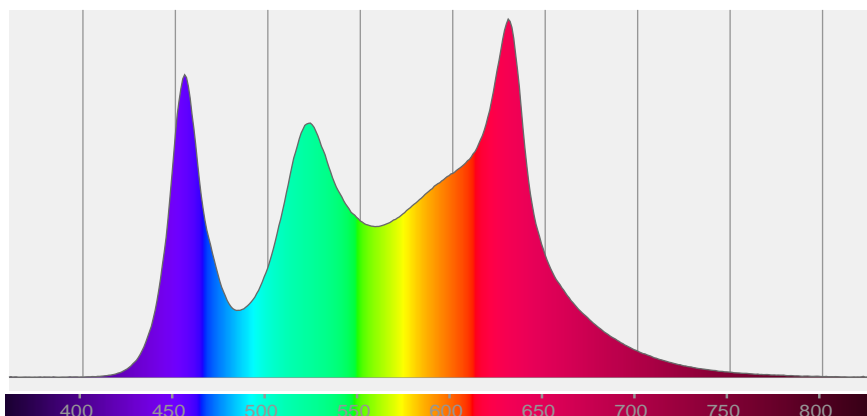

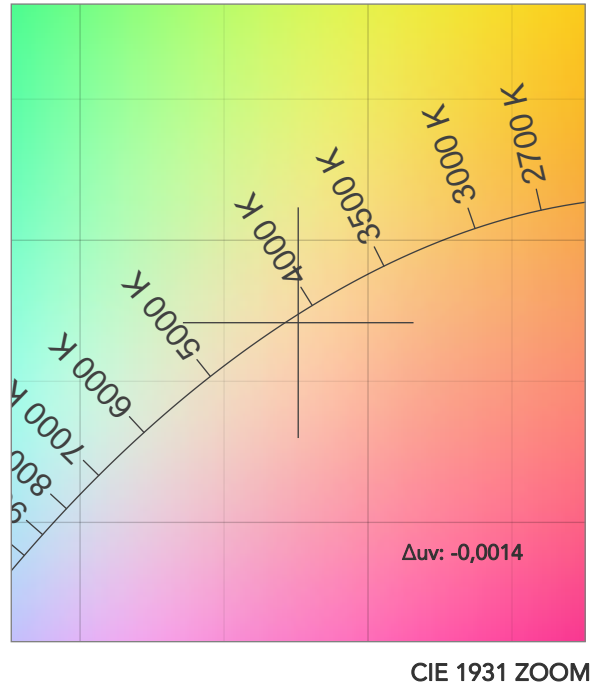
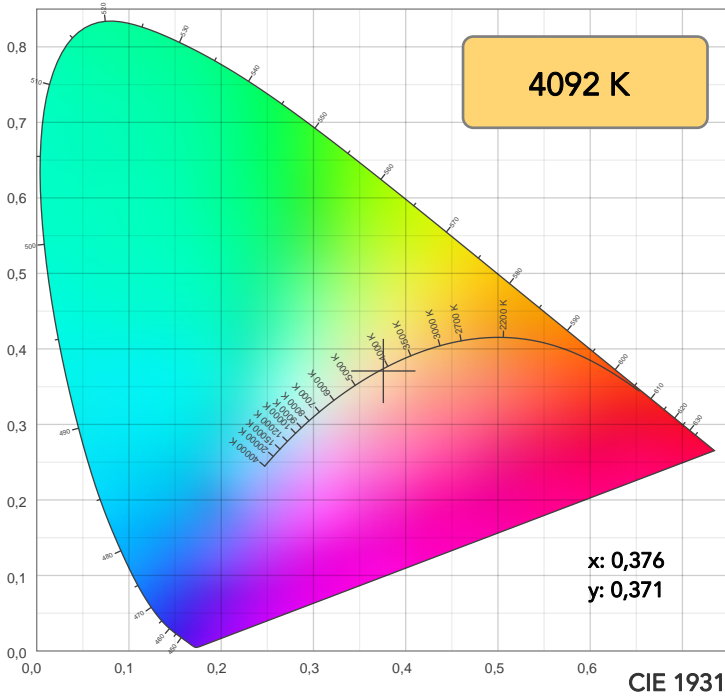

TM30: 89,7

CRI: 92,0 (R1-R8)

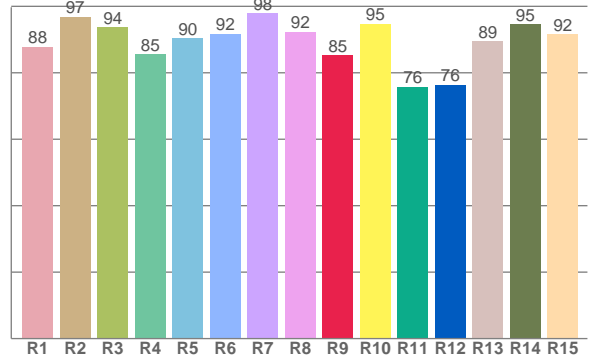
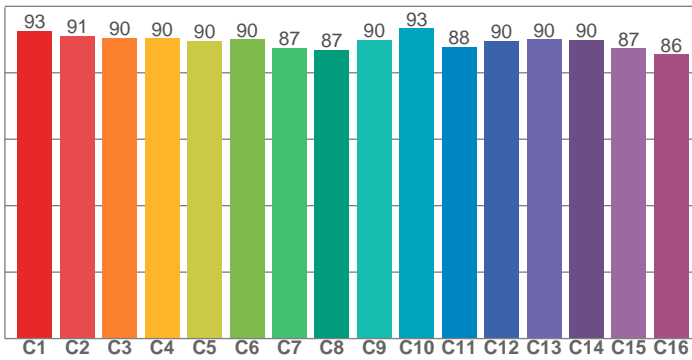

CRI R values, only R1-R8 are used to calculate final CRI value

R1	R2	R3	R4	R5	R6	R7	R8	R9	R10	R11	R12	R13	R14	R15
87,9	96,9	93,8	85,5	90,3	91,7	97,8	92,4	85,3	94,8	75,8	76,4	89,4	94,6	91,5

TM30 C values, 16 binned values out of total of 99 C values

C1	C2	C3	C4	C5	C6	C7	C8	C9	C10	C11	C12	C13	C14	C15	C16
92,6	91,2	90,4	90,3	89,6	90,0	87,5	86,8	90,0	93,3	87,8	89,7	90,0	89,9	87,3	85,6

CQS Q values

Q1	Q2	Q3	Q4	Q5	Q6	Q7	Q8	Q9	Q10	Q11	Q12	Q13	Q14	Q15
93,5	97,8	92,4	98,2	95,8	94,0	97,4	96,0	96,0	99,6	92,1	91,1	93,0	95,1	94,6

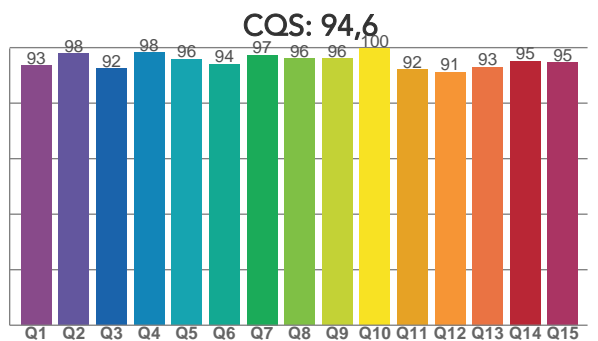

COLOR PARAMETERS

Color temperature	Color rendering index	Red component	Color fidelity	Color gamut	Color quality scale	Television lighting index	Color coordinate cie 1931	Color coordinate cie 1931	Color deviation from black body
CCT	CRI	CRI R9	TM30 Rf	TM30 Rg	CQS	TLCI	x	y	Δuv
4092 K	92,0	85,3	89,7	103,9	94,6	87	0,376	0,371	-0,0014

# TM30 DETAILS

**Rf 89,7**  
Fidelity index Rf

**Rg 103,9**  
Gammut index

Hue Bin	R <sub>f</sub>	Graphic shifts (%)	
		Chroma	Hue
1	93	2%	0%
2	91	3%	-2%
3	90	1%	-3%
4	90	-3%	-4%
5	90	-4%	1%
6	90	3%	5%
7	87	4%	4%
8	87	4%	3%
9	90	4%	4%
10	93	1%	3%
11	88	5%	5%
12	90	4%	0%
13	90	3%	-5%
14	90	1%	4%
15	87	3%	-3%
16	86	4%	-4%

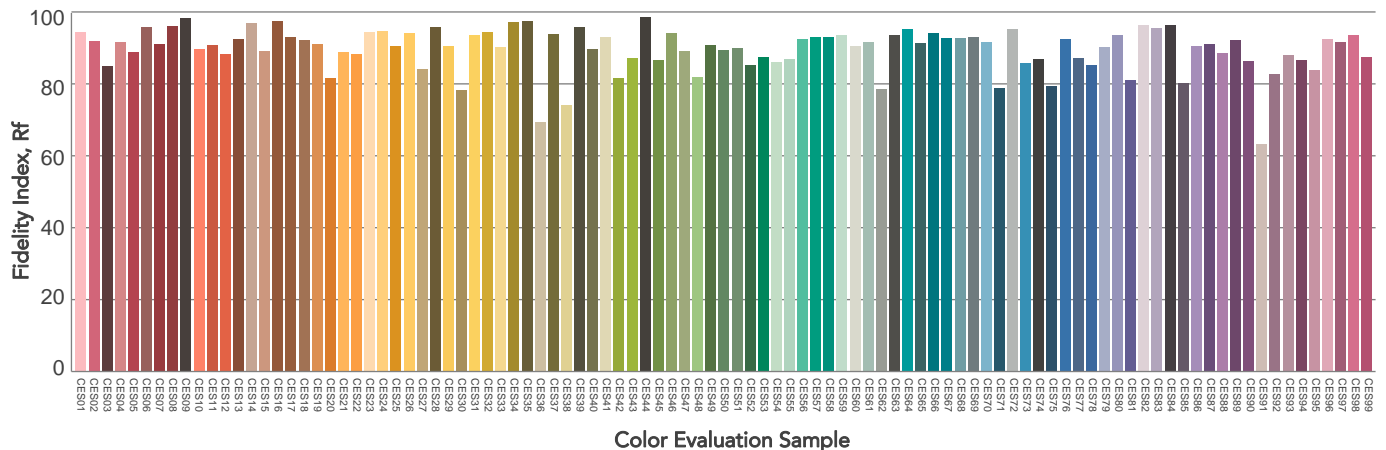
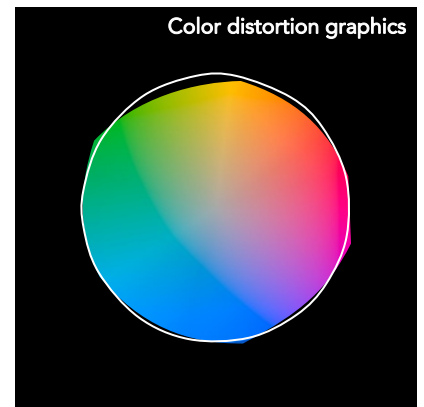
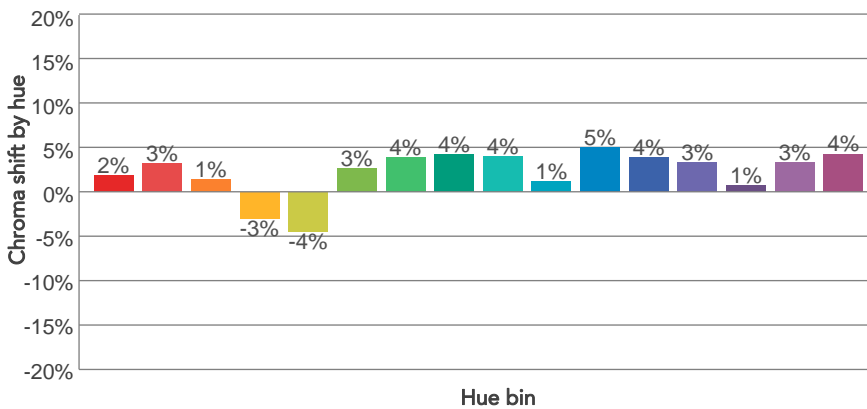
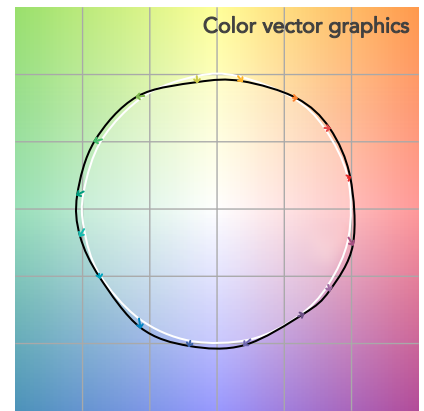
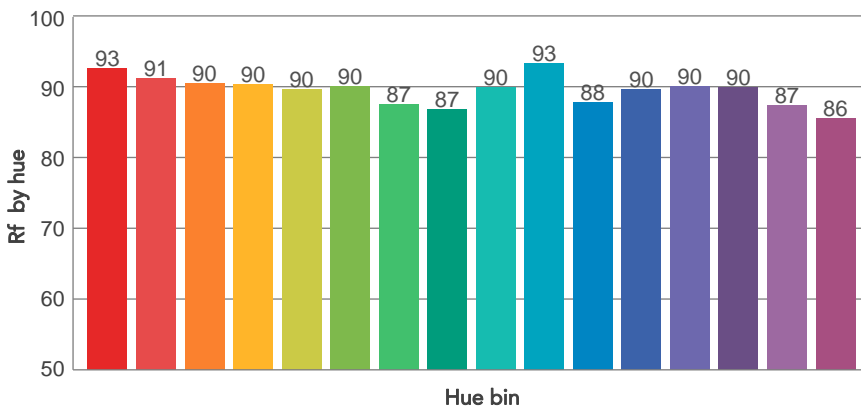
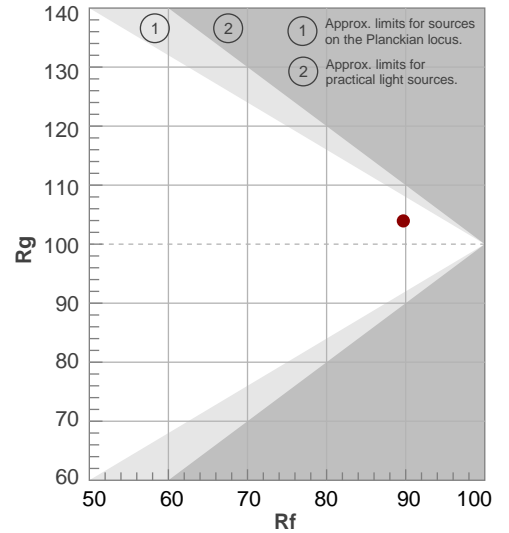



# BEAM DETAILS



Beam angle 50%	Field angle 10%	Cut off angle 2,5%	Intensity ratio in 120° cone	Intensity ratio in 90° cone
101,9°	158,2°	177,2°	79,0%	55,3%

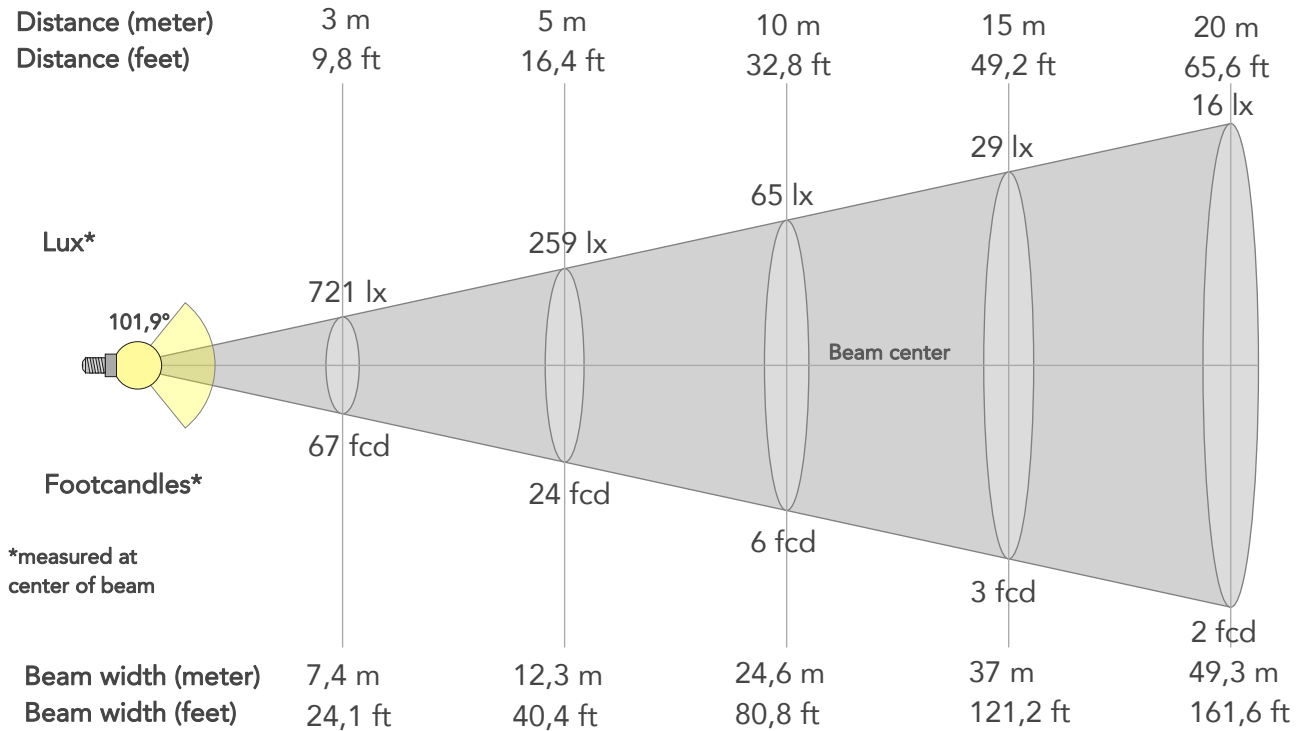

## BEAM INTENSITIES AND WIDTHS

Distance	1m	2m	3m	4m	5m	7,5m	10m	15m	20m	25m	30m	40m	50m
Distance	3,3ft	6,6ft	9,8ft	13,1ft	16,4ft	24,6ft	32,8ft	49,2ft	65,6ft	82ft	98,4ft	131,2ft	164ft
Lux	6486lx	1622lx	721lx	405lx	259lx	115lx	65lx	29lx	16lx	10lx	7lx	4lx	3lx
Footcand.	603fcd	151fcd	67fcd	38fcd	24fcd	11fcd	6fcd	3fcd	2fcd	1fcd	1fcd	0fcd	0fcd
Beam wid.	2,5m	4,9m	7,4m	9,9m	12,3m	18,5m	24,6m	37m	49,3m	61,6m	73,9m	98,6m	123,2m
Beam wid.	8,1ft	16,3ft	24,1ft	32,3ft	40,4ft	60,6ft	80,8ft	121,2ft	161,6ft	202ft	242,5ft	323,3ft	404,1ft

## LINEAR DISTRIBUTION DIAGRAM

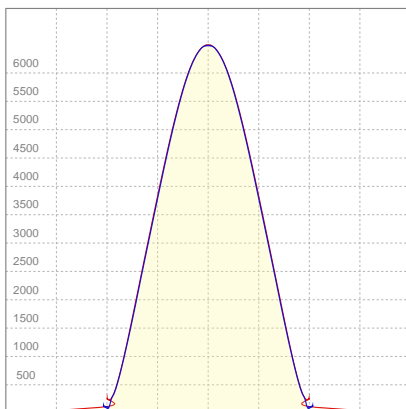

## ELECTRICAL SPECIFICATIONS

Input voltage	Input current	Input power	Effeciency
225V	1,02A	226,5W	74lm/W

## ISO CANDELA DIAGRAM

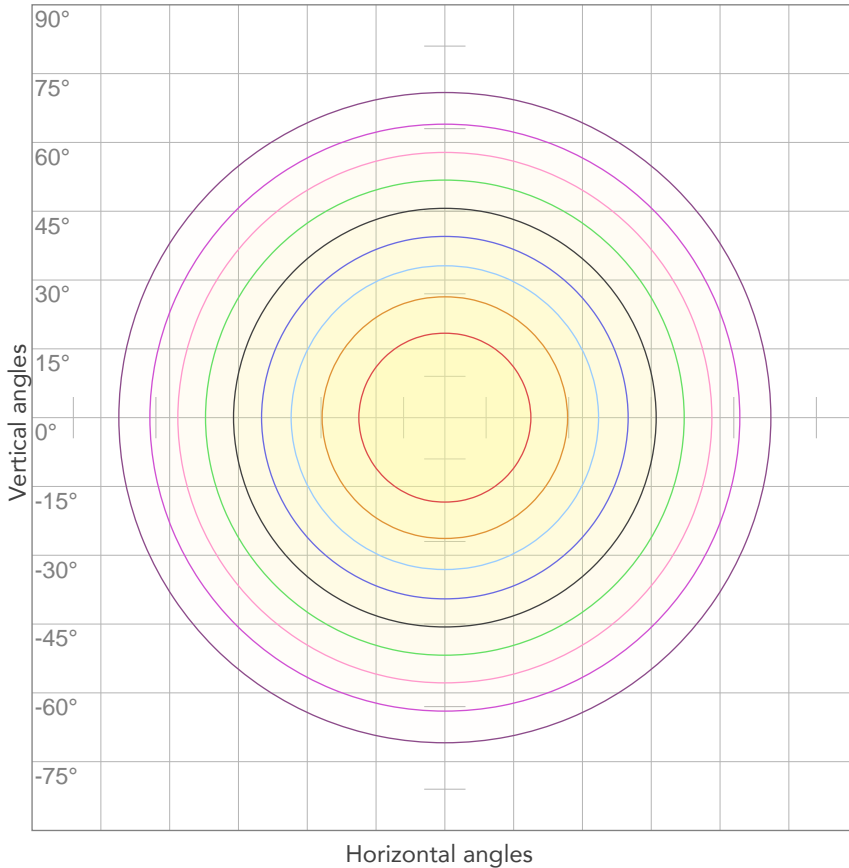

10%	649 cd
20%	1297 cd
30%	1946 cd
40%	2594 cd
50%	3243 cd
60%	3892 cd
70%	4540 cd
80%	5189 cd

Conditions:

Number of c-planes: 4

Candela at center: 6486 cd

## ISO LUX DIAGRAM

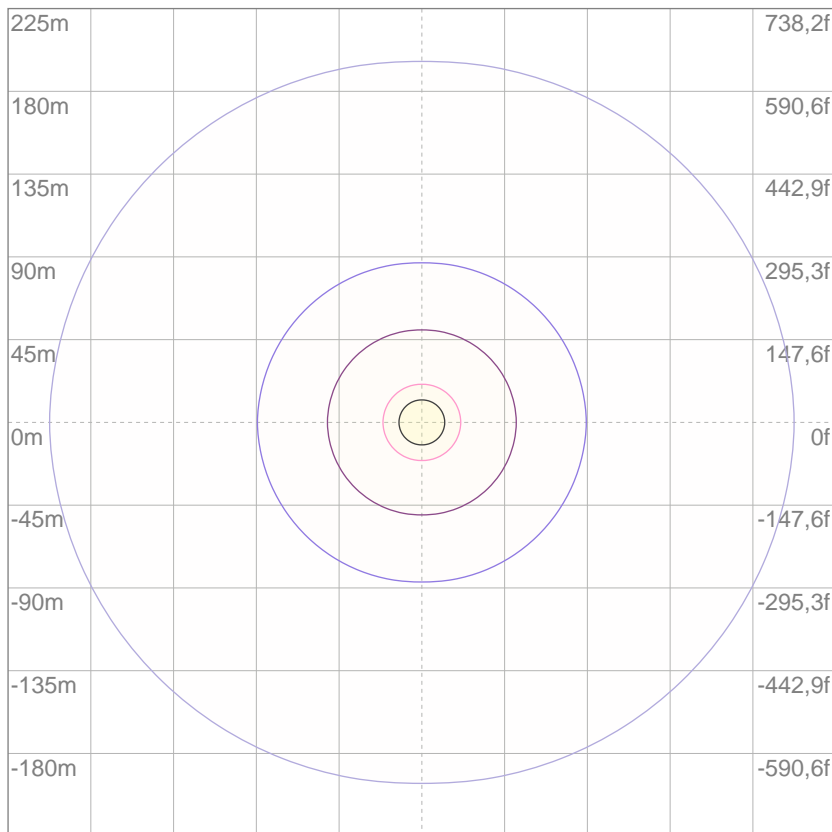

3%	1,95 lx
5%	3,24 lx
10%	6,49 lx
30%	19,5 lx
50%	32,4 lx

Conditions:

Number of c-planes: 4

Lux at center: 64,9 lx

*Lux distribution on a surface when lamp is mounted at 10 meters from the surface.*

Mounting height: 10 meters (33 feet)



Total lumen output:

17109 lm

Peak candela output:

6631 cd

Light quality:

CRI: 92,1

Color temperature:

4115 K

**PRODUCT NAME:**

ECLPANEL TWCJR

**MEASUREMENT CONDITIONS:**

Beam angle:

Filter LD

Target:

4000K

Operator:

Paolo Carvone

Date and time:

14/05/2020 15:51:36

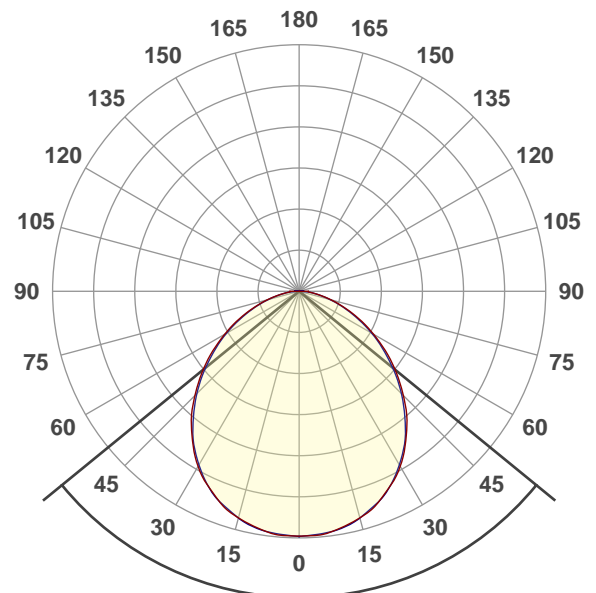

Beam angle 50%: 101,5°

Field angle 10%: 155,8°

Cut off angle 2.5%: 176°

Spectra

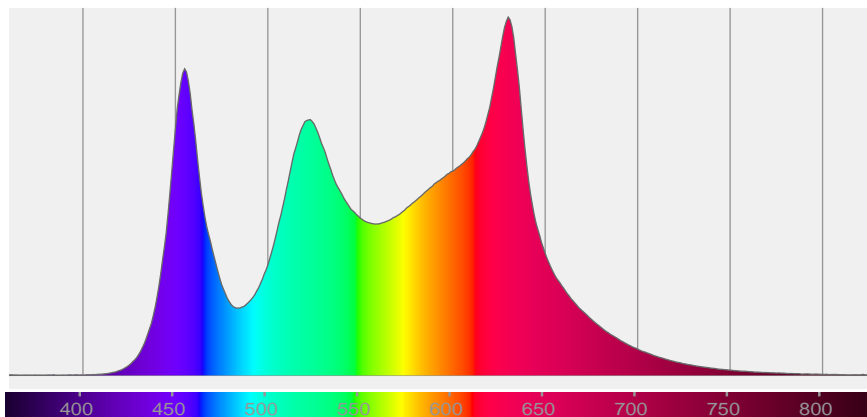

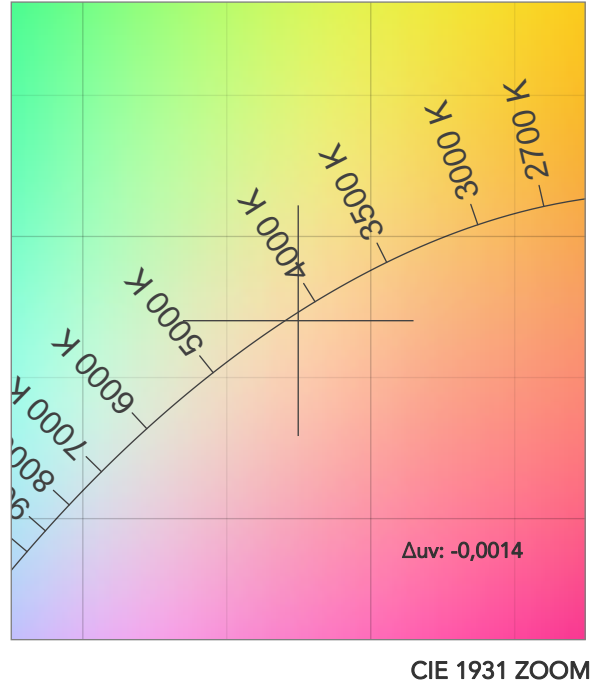
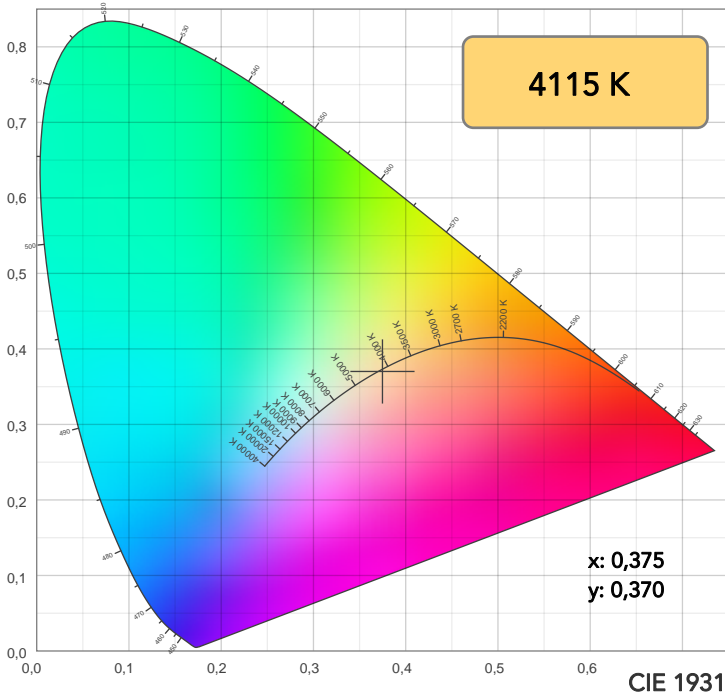

TM30: 89,7

CRI: 92,1 (R1-R8)

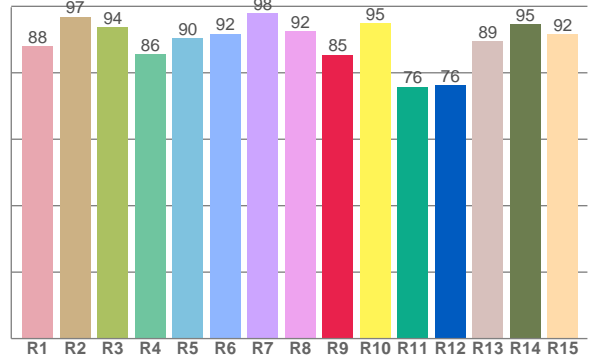
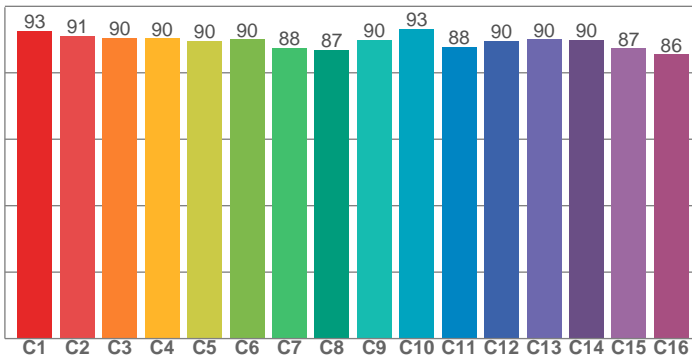

CRI R values, only R1-R8 are used to calculate final CRI value

R1	R2	R3	R4	R5	R6	R7	R8	R9	R10	R11	R12	R13	R14	R15
87,9	96,9	93,8	85,5	90,4	91,8	97,9	92,5	85,4	94,9	75,8	76,2	89,5	94,5	91,5

TM30 C values, 16 binned values out of total of 99 C values

C1	C2	C3	C4	C5	C6	C7	C8	C9	C10	C11	C12	C13	C14	C15	C16
92,6	91,2	90,5	90,3	89,6	90,0	87,5	86,9	90,0	93,3	87,8	89,6	90,0	89,8	87,3	85,5

CQS Q values

Q1	Q2	Q3	Q4	Q5	Q6	Q7	Q8	Q9	Q10	Q11	Q12	Q13	Q14	Q15
93,5	97,8	92,3	98,2	95,8	94,0	97,4	96,0	96,0	99,7	92,2	91,2	93,0	95,1	94,6

CQS: 94,6

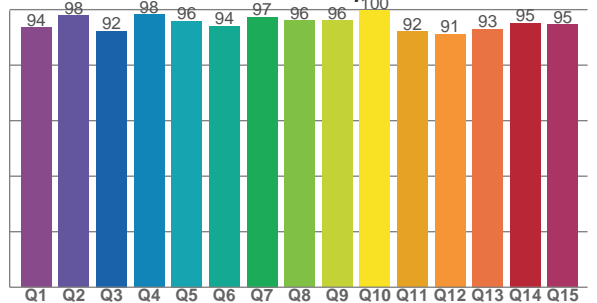

COLOR PARAMETERS

Color temperature	Color rendering index	Red component	Color fidelity	Color gamut	Color quality scale	Television lighting index	Color coordinate cie 1931	Color coordinate cie 1931	Color deviation from black body
CCT	CRI	CRI R9	TM30 Rf	TM30 Rg	CQS	TLCI	x	y	Δuv
4115 K	92,1	85,4	89,7	103,9	94,6	87	0,375	0,370	-0,0014

# TM30 DETAILS

**Rf 89,7**  
Fidelity index Rf

**Rg 103,9**  
Gammut index

Hue Bin	R <sub>f</sub>	Graphic shifts (%)	
		Chroma	Hue
1	93	2%	0%
2	91	3%	-2%
3	90	1%	-3%
4	90	-3%	-4%
5	90	-4%	1%
6	90	3%	5%
7	88	4%	4%
8	87	4%	3%
9	90	4%	4%
10	93	1%	3%
11	88	5%	5%
12	90	4%	0%
13	90	3%	-5%
14	90	1%	4%
15	87	3%	-3%
16	86	4%	-4%

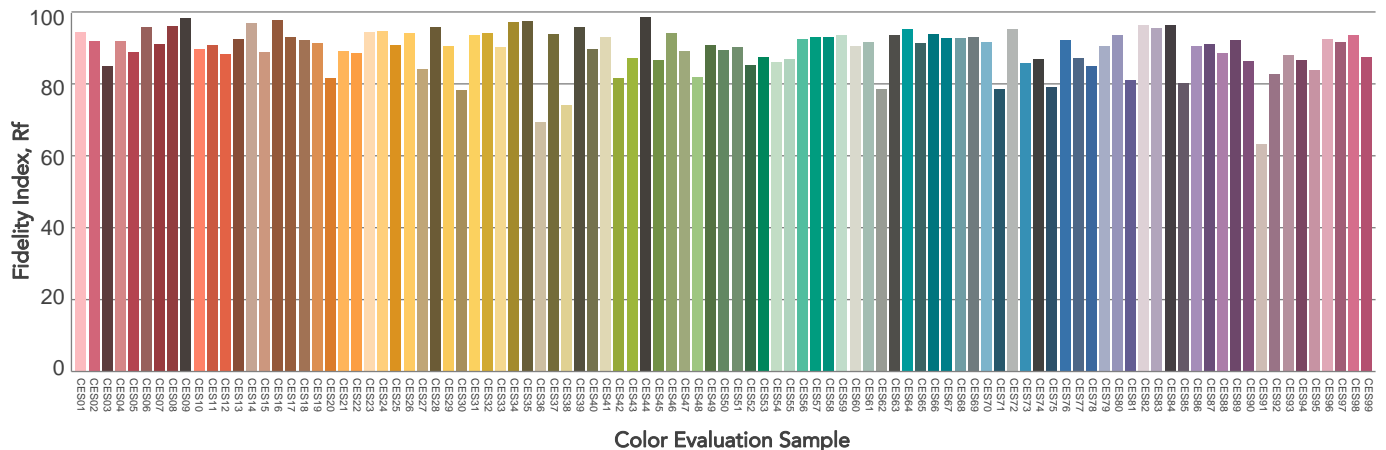
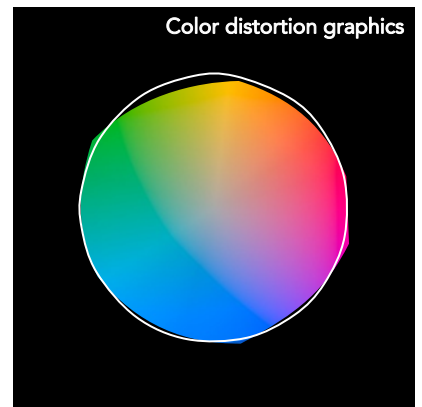
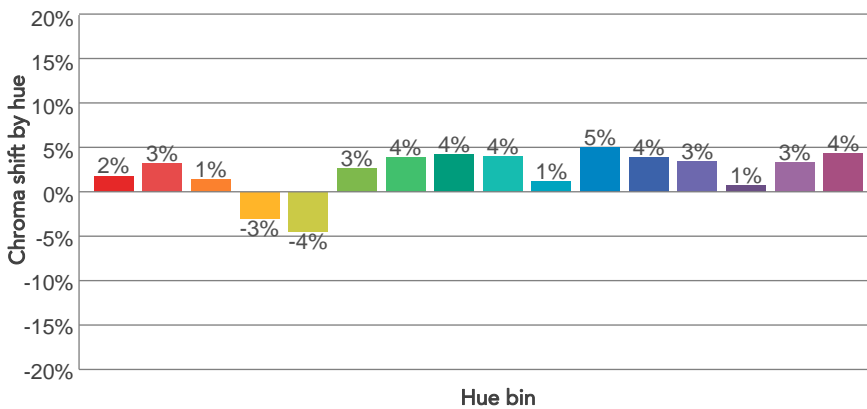
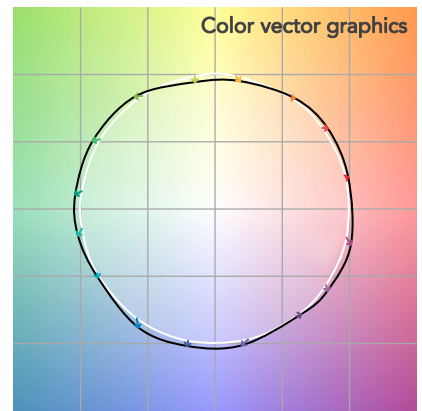
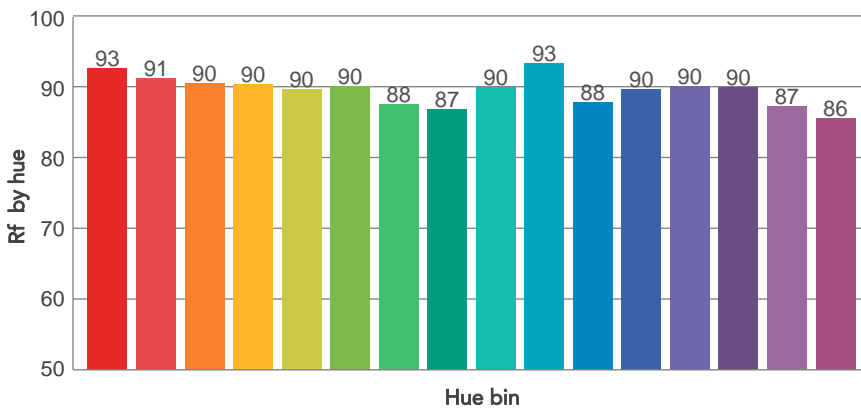
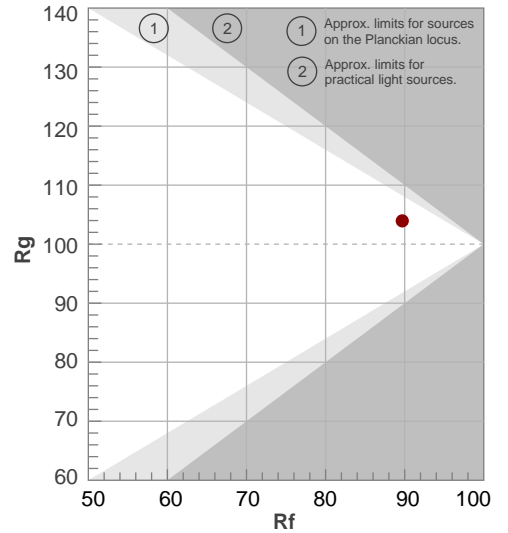

# BEAM DETAILS



Beam angle 50%	Field angle 10%	Cut off angle 2,5%	Intensity ratio in 120° cone	Intensity ratio in 90° cone
101,5°	155,8°	176°	80,7%	57,1%

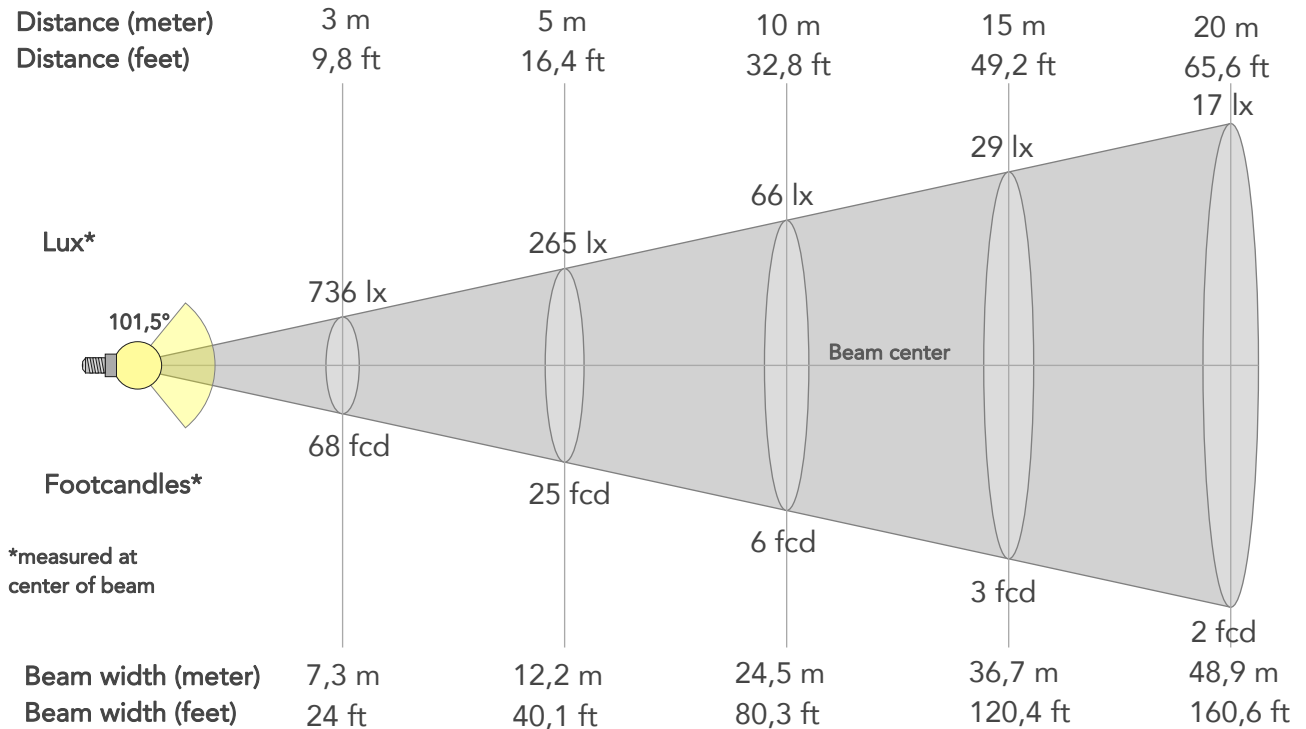

## BEAM INTENSITIES AND WIDTHS

Distance	1m	2m	3m	4m	5m	7,5m	10m	15m	20m	25m	30m	40m	50m
Distance	3,3ft	6,6ft	9,8ft	13,1ft	16,4ft	24,6ft	32,8ft	49,2ft	65,6ft	82ft	98,4ft	131,2ft	164ft
Lux	6627lx	1657lx	736lx	414lx	265lx	118lx	66lx	29lx	17lx	11lx	7lx	4lx	3lx
Footcand.	616fcd	154fcd	68fcd	38fcd	25fcd	11fcd	6fcd	3fcd	2fcd	1fcd	1fcd	0fcd	0fcd
Beam wid.	2,4m	4,9m	7,3m	9,8m	12,2m	18,4m	24,5m	36,7m	48,9m	61,2m	73,4m	97,9m	122,4m
Beam wid.	8,1ft	16,2ft	24ft	32,1ft	40,1ft	60,2ft	80,3ft	120,4ft	160,6ft	200,7ft	240,8ft	321,1ft	401,4ft

## LINEAR DISTRIBUTION DIAGRAM

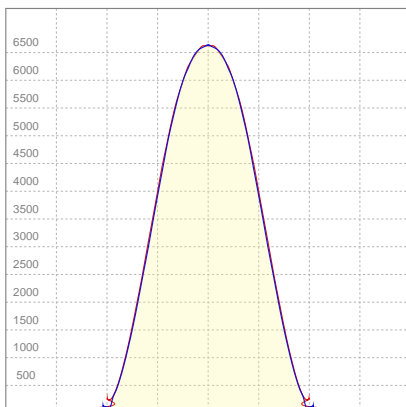

## ELECTRICAL SPECIFICATIONS

Input voltage	Input current	Input power	Effeciency
224V	1,03A	227,2W	75lm/W

## ISO CANDELA DIAGRAM

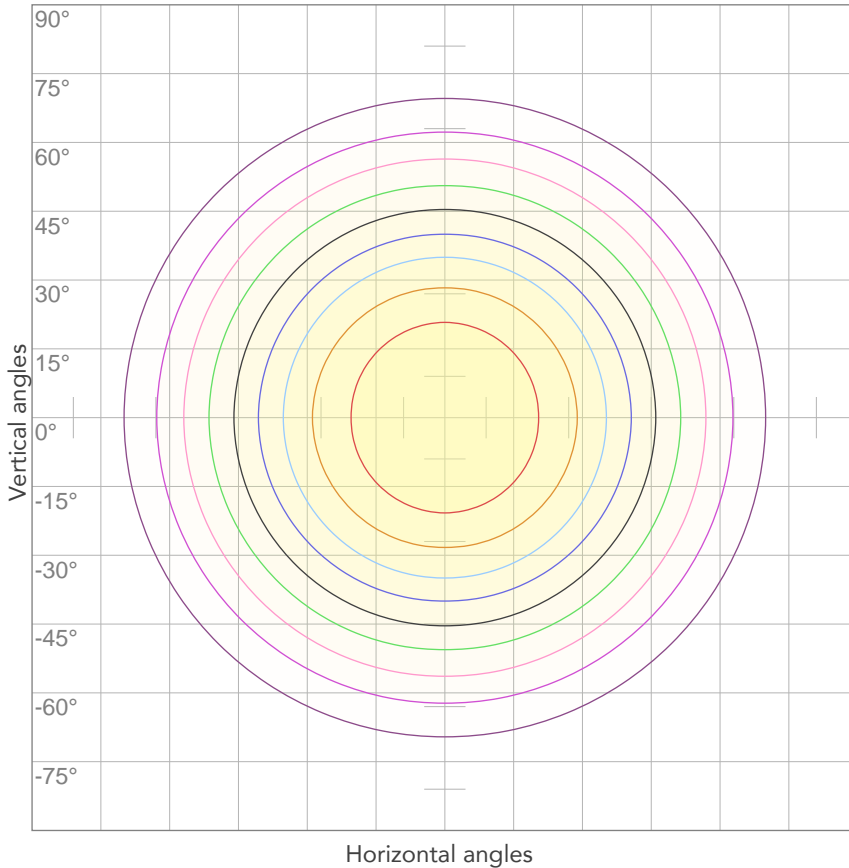

10%	663 cd
20%	1325 cd
30%	1988 cd
40%	2651 cd
50%	3313 cd
60%	3976 cd
70%	4639 cd
80%	5302 cd

Conditions:

Number of c-planes: 4

Candela at center: 6627 cd

## ISO LUX DIAGRAM

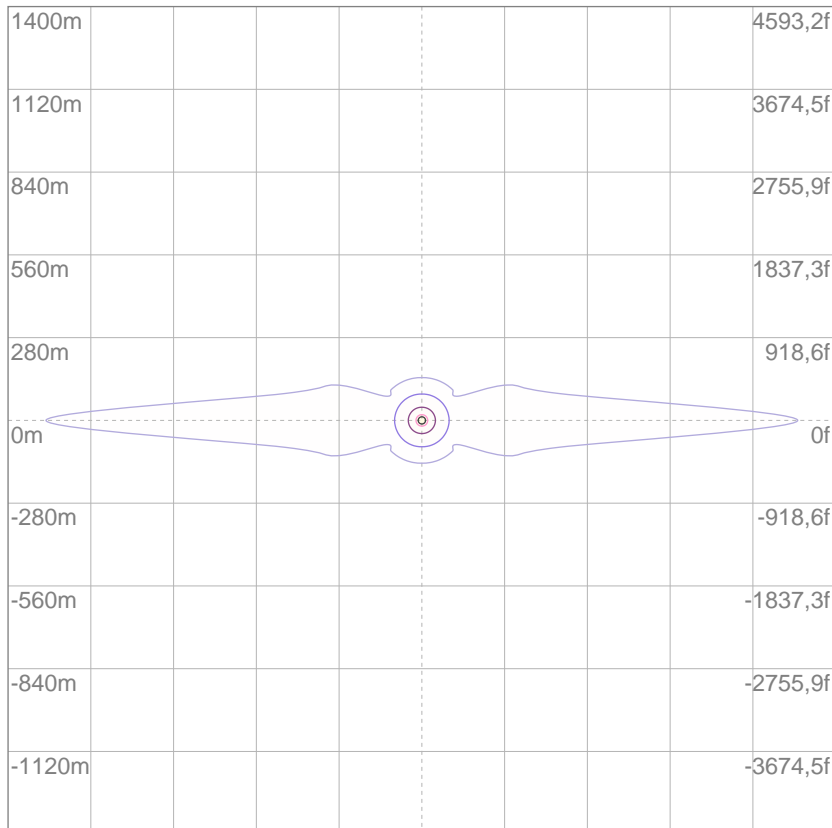

Mounting height: 10 meters (33 feet)

3%	1,99 lx
5%	3,31 lx
10%	6,63 lx
30%	19,9 lx
50%	33,1 lx

Conditions:

Number of c-planes: 4

Lux at center: 66,3 lx

*Lux distribution on a surface when lamp is mounted at 10 meters from the surface.*



Total lumen output:

14856 lm

Peak candela output:

9716 cd

Light quality:

CRI: 94,6

Color temperature:

3964 K

**PRODUCT NAME:**

ECLPANEL TWCJR

**MEASUREMENT CONDITIONS:**

Beam angle:

Filter INT

Target:

4000K

Operator:

Paolo Carvone

Date and time:

13/11/2020 12:16:46

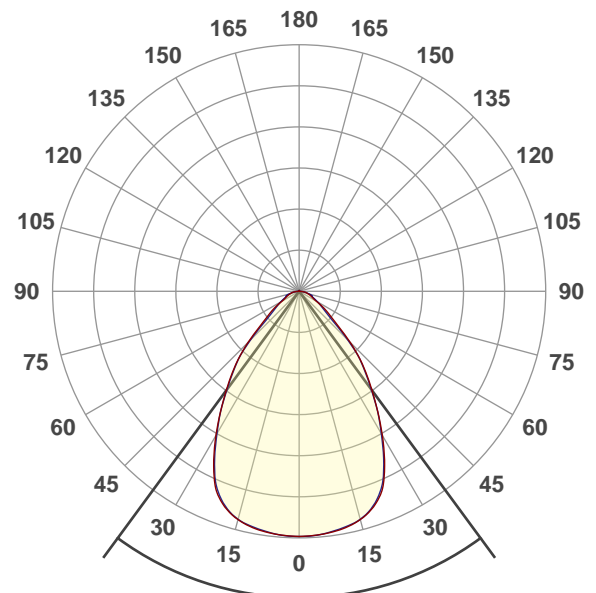

Beam angle 50%: 72,6°

Field angle 10%: 115,6°

Cut off angle 2.5%: 161°

Spectra

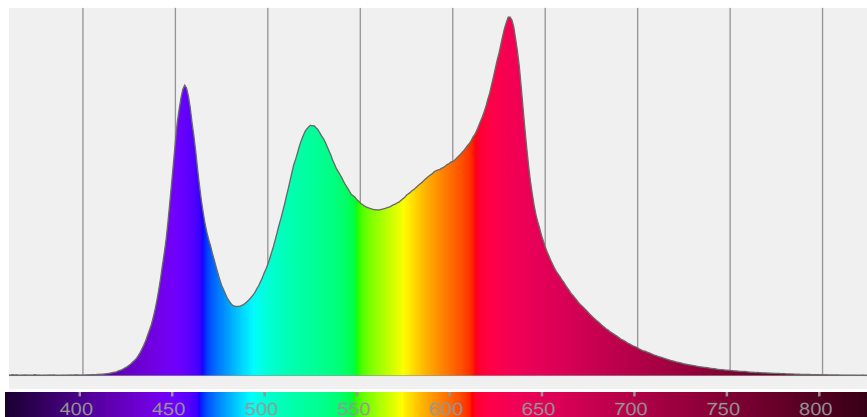



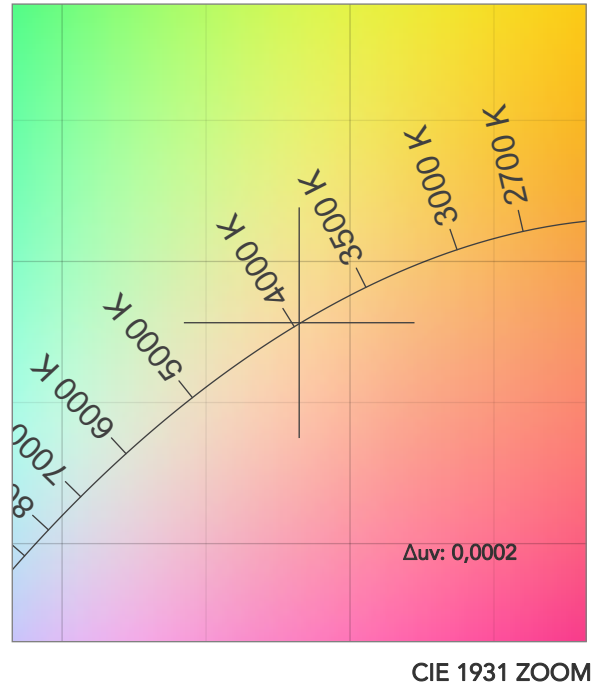
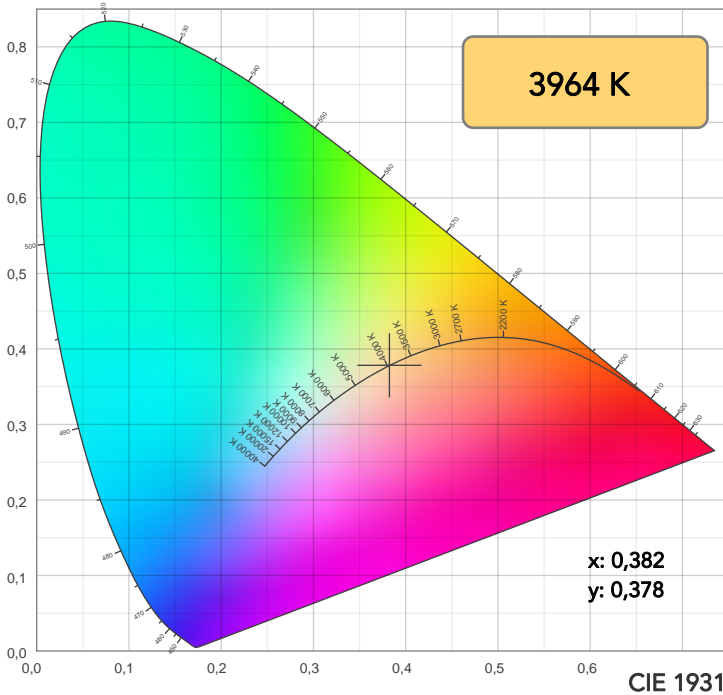

TM30: 90,4

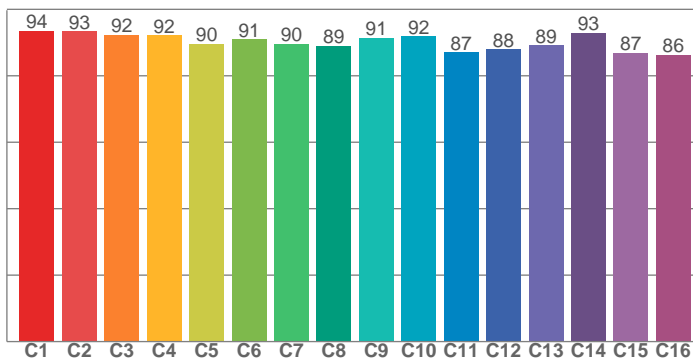

CRI: 94,6 (R1-R8)

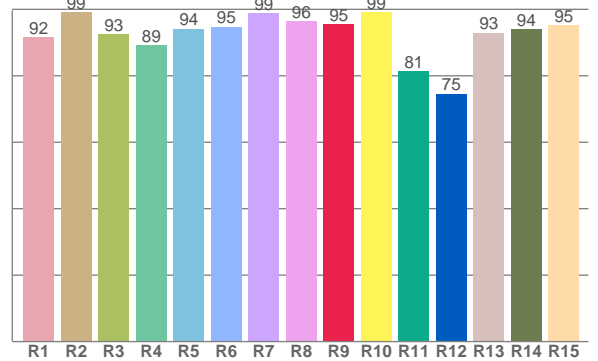

CRI R values, only R1-R8 are used to calculate final CRI value

R1	R2	R3	R4	R5	R6	R7	R8	R9	R10	R11	R12	R13	R14	R15
91,6	99,1	92,5	89,2	94,2	94,8	98,8	96,3	95,4	99,2	81,3	74,6	93,0	94,0	95,1

TM30 C values, 16 binned values out of total of 99 C values

C1	C2	C3	C4	C5	C6	C7	C8	C9	C10	C11	C12	C13	C14	C15	C16
93,5	93,4	92,4	92,1	89,7	91,0	89,6	89,0	91,4	91,8	87,0	87,9	89,2	93,0	87,0	86,3

CQS Q values

Q1	Q2	Q3	Q4	Q5	Q6	Q7	Q8	Q9	Q10	Q11	Q12	Q13	Q14	Q15
93,4	97,6	91,0	96,4	97,9	94,8	96,3	97,6	95,8	98,7	94,4	93,0	94,0	96,2	96,0

CQS: 95,1

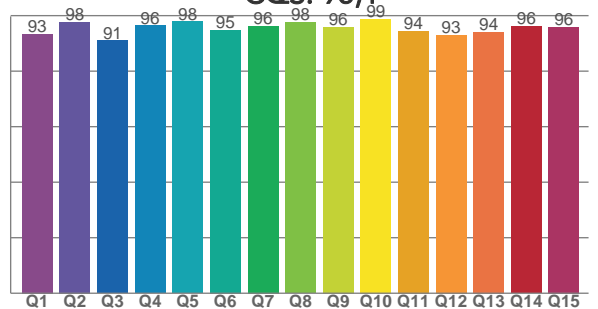

COLOR PARAMETERS

Color temperature	Color rendering index	Red component	Color fidelity	Color gamut	Color quality scale	Television lighting index	Color coordinate cie 1931	Color coordinate cie 1931	Color deviation from black body
CCT	CRI	CRI R9	TM30 Rf	TM30 Rg	CQS	TLCI	x	y	$\Delta uv$
3964 K	94,6	95,4	90,4	102,9	95,1	89	0,382	0,378	0,0002

# TM30 DETAILS

**Rf 90,4**  
Fidelity index Rf

**Rg 102,9**  
Gammut index

Hue Bin	R <sub>f</sub>	Graphic shifts (%)	
		Chroma	Hue
1	94	0%	0%
2	93	2%	-2%
3	92	1%	-1%
4	92	-3%	-2%
5	90	-4%	1%
6	91	2%	4%
7	90	3%	3%
8	89	3%	3%
9	91	3%	5%
10	92	0%	4%
11	87	5%	6%
12	88	4%	0%
13	89	4%	-5%
14	93	2%	3%
15	87	3%	-4%
16	86	3%	-5%

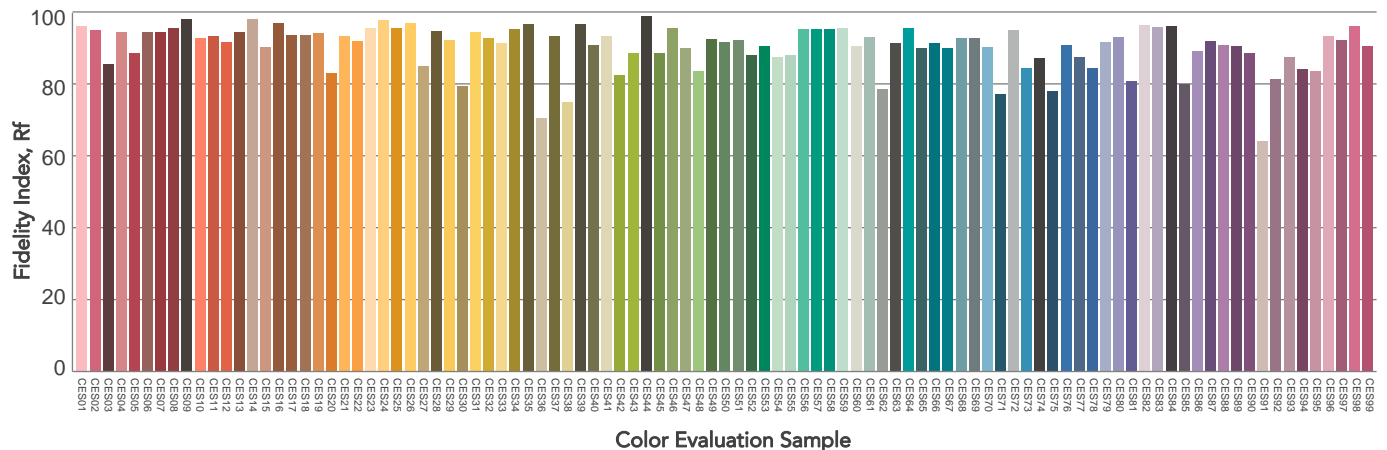
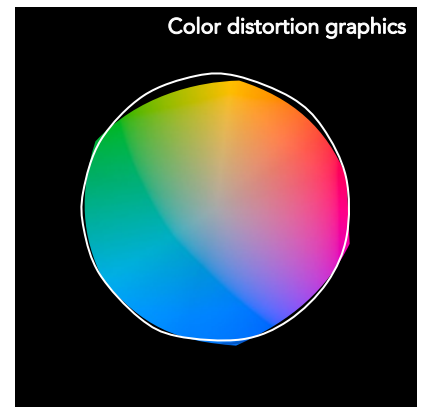
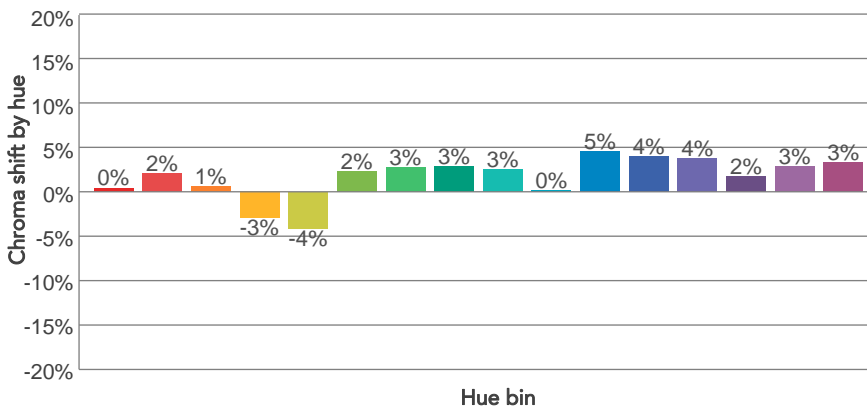
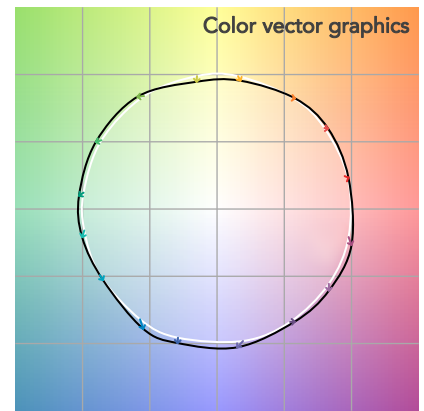
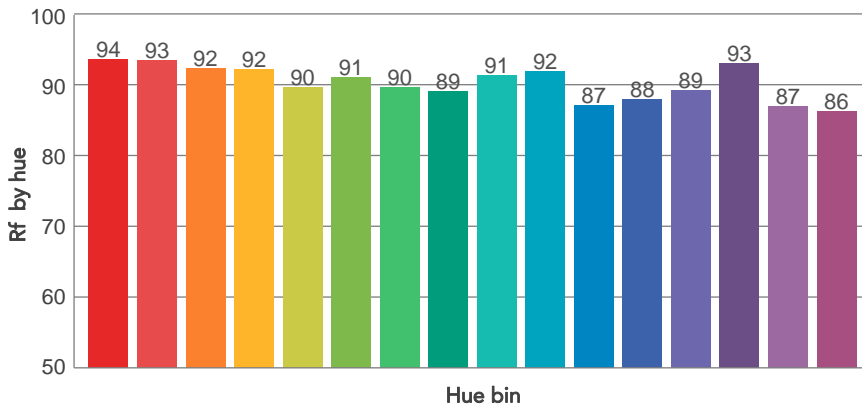
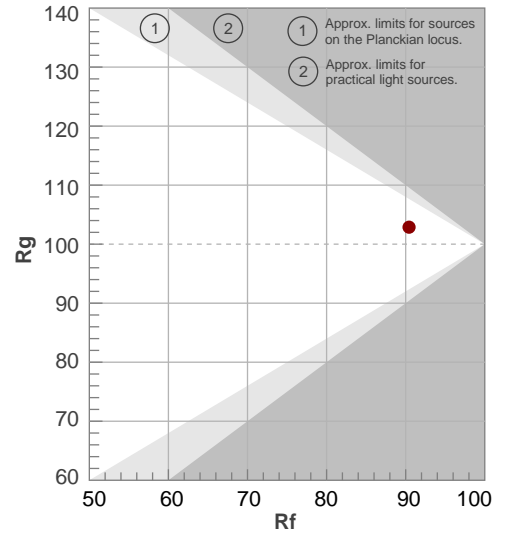

# BEAM DETAILS



Beam angle 50%	Field angle 10%	Cut off angle 2,5%	Intensity ratio in 120° cone	Intensity ratio in 90° cone
72,6°	115,6°	161°	91,8%	78,6%

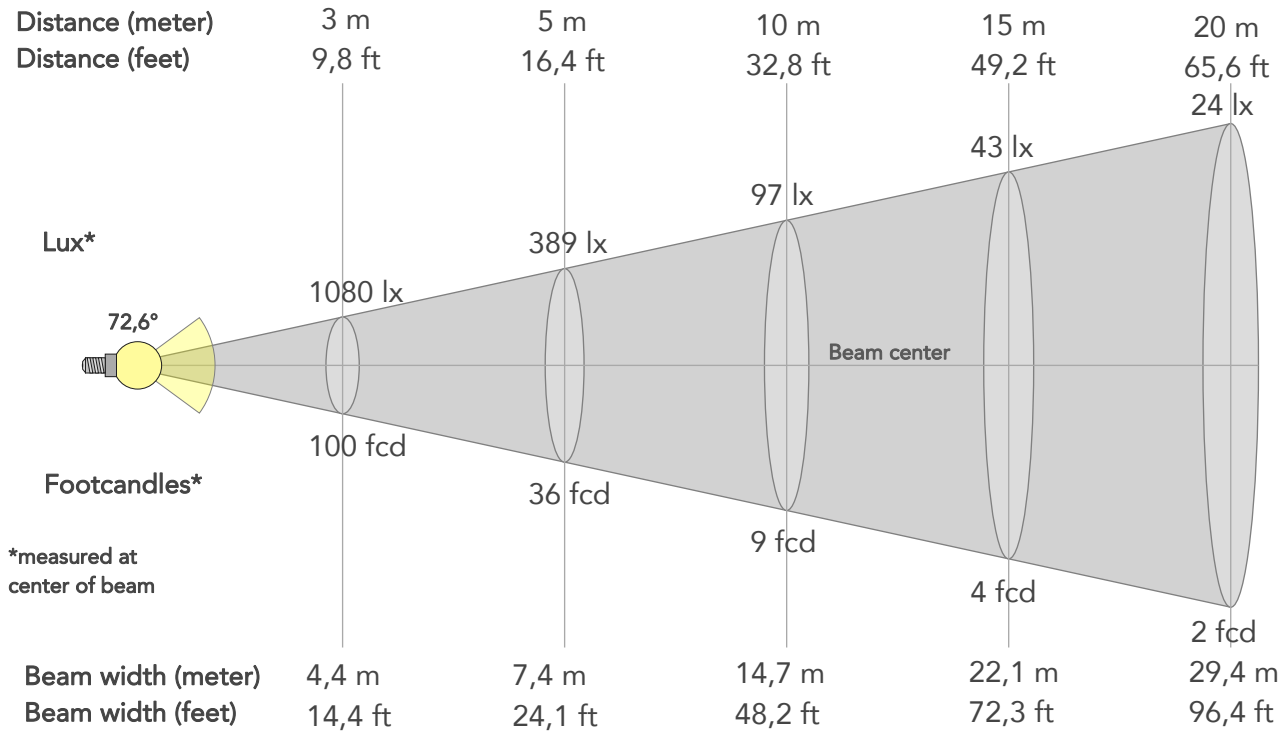

## BEAM INTENSITIES AND WIDTHS

Distance	1m	2m	3m	4m	5m	7,5m	10m	15m	20m	25m	30m	40m	50m
Distance	3,3ft	6,6ft	9,8ft	13,1ft	16,4ft	24,6ft	32,8ft	49,2ft	65,6ft	82ft	98,4ft	131,2ft	164ft
Lux	9716lx	2429lx	1080lx	607lx	389lx	173lx	97lx	43lx	24lx	16lx	11lx	6lx	4lx
Footcand.	903fcd	226fcd	100fcd	56fcd	36fcd	16fcd	9fcd	4fcd	2fcd	1fcd	1fcd	1fcd	0fcd
Beam wid.	1,5m	2,9m	4,4m	5,9m	7,4m	11m	14,7m	22,1m	29,4m	36,8m	44,1m	58,8m	73,5m
Beam wid.	4,9ft	9,7ft	14,4ft	19,3ft	24,1ft	36,2ft	48,2ft	72,3ft	96,4ft	120,5ft	144,7ft	192,9ft	241,1ft

## LINEAR DISTRIBUTION DIAGRAM

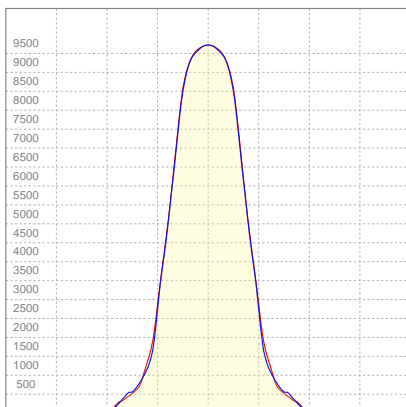

## ELECTRICAL SPECIFICATIONS

Input voltage	Input current	Input power	Effeciency
227V	1,06A	230,5W	64lm/W

## ISO CANDELA DIAGRAM

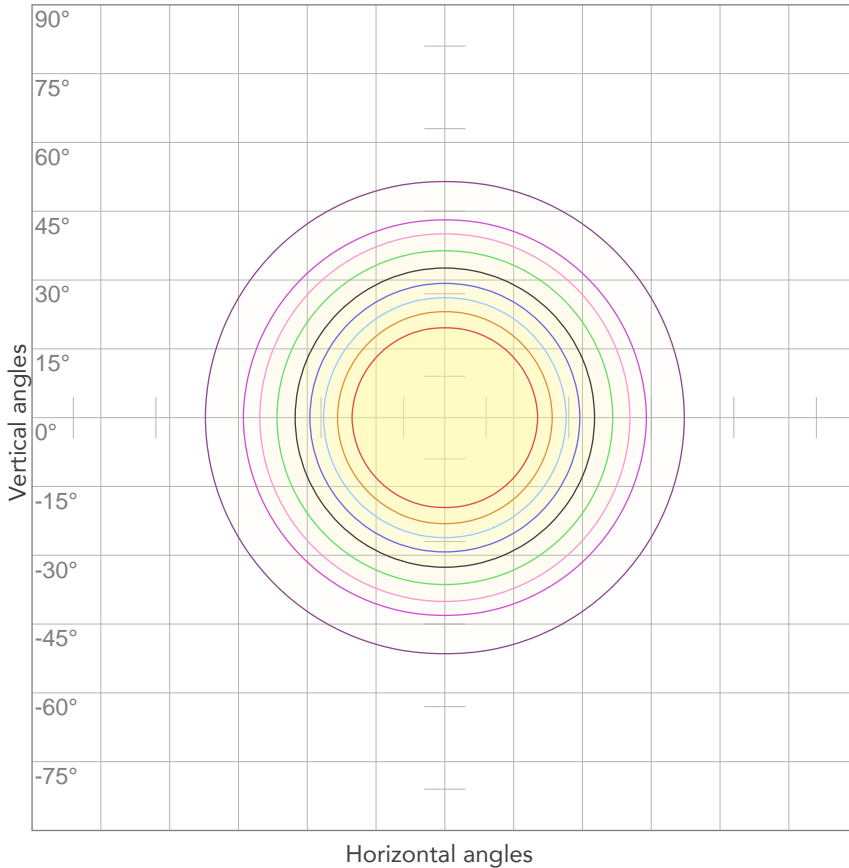

10%	972 cd
20%	1943 cd
30%	2915 cd
40%	3886 cd
50%	4858 cd
60%	5830 cd
70%	6801 cd
80%	7773 cd

Conditions:

Number of c-planes: 4

Candela at center: 9716 cd

## ISO LUX DIAGRAM

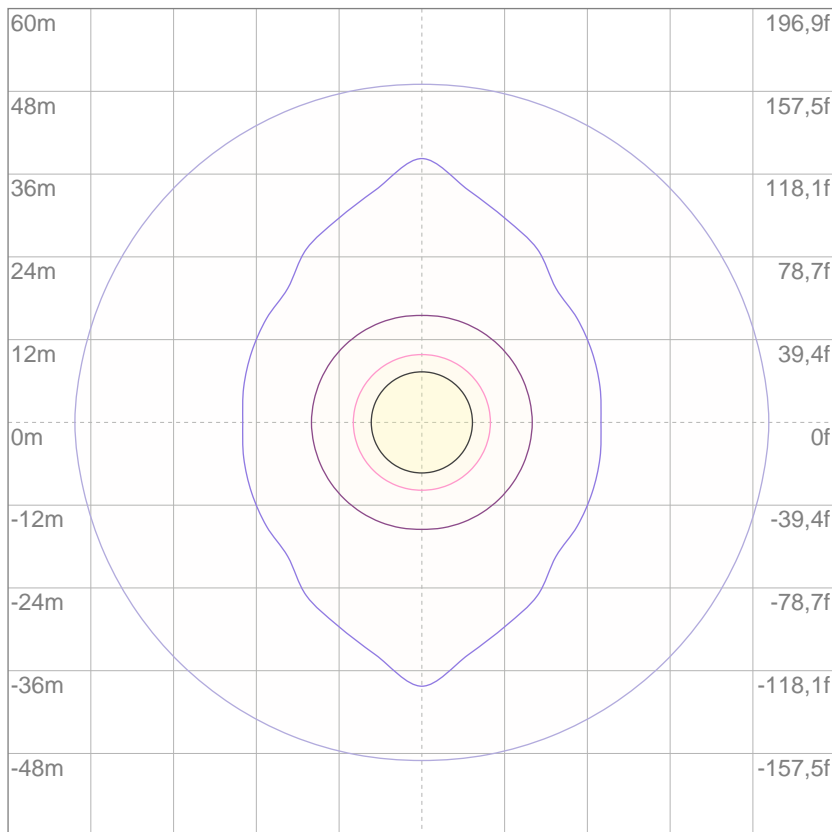

3%	2,91 lx
5%	4,86 lx
10%	9,72 lx
30%	29,1 lx
50%	48,6 lx

Conditions:

Number of c-planes: 4

Lux at center: 97,2 lx

*Lux distribution on a surface when lamp is mounted at 10 meters from the surface.*

Mounting height: 10 meters (33 feet)



Total lumen output:

14060 lm

Peak candela output:

4914 cd

Light quality:

CRI: 91,2

Color temperature:

6138 K

**PRODUCT NAME:**

ECLPANEL TWCJR

**MEASUREMENT CONDITIONS:**

Beam angle:

Filter HD

Target:

5600K

Operator:

Paolo Carvone

Date and time:

14/05/2020 16:26:03

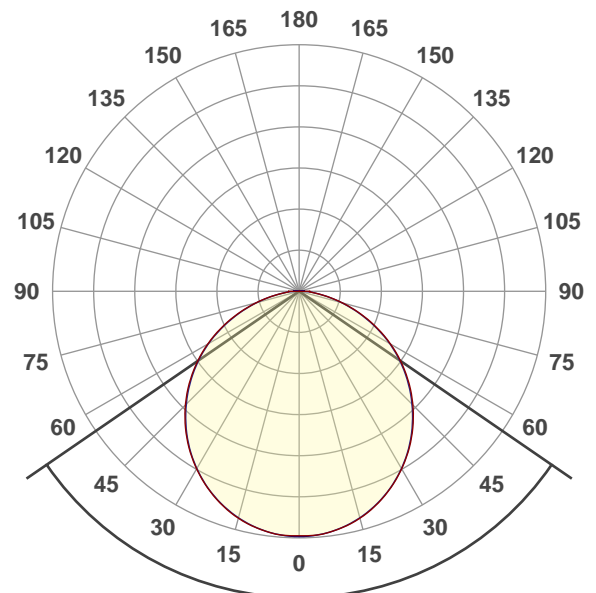

Beam angle 50%: 111°

Field angle 10%: 161,2°

Cut off angle 2.5%: 177,6°

Spectra

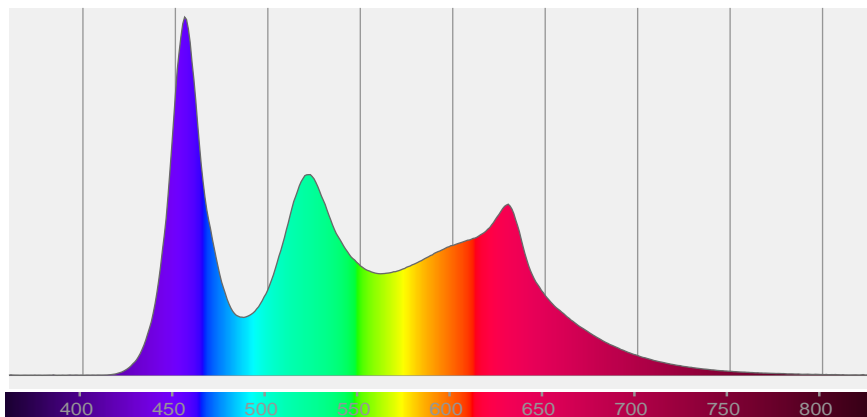

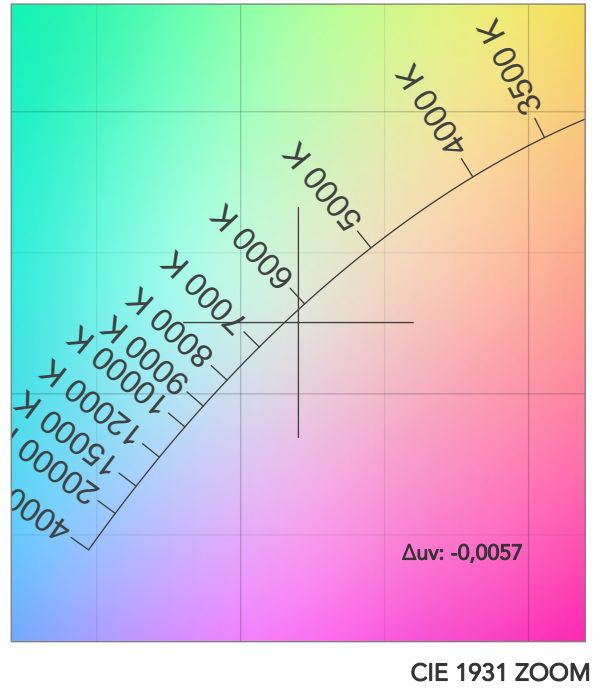
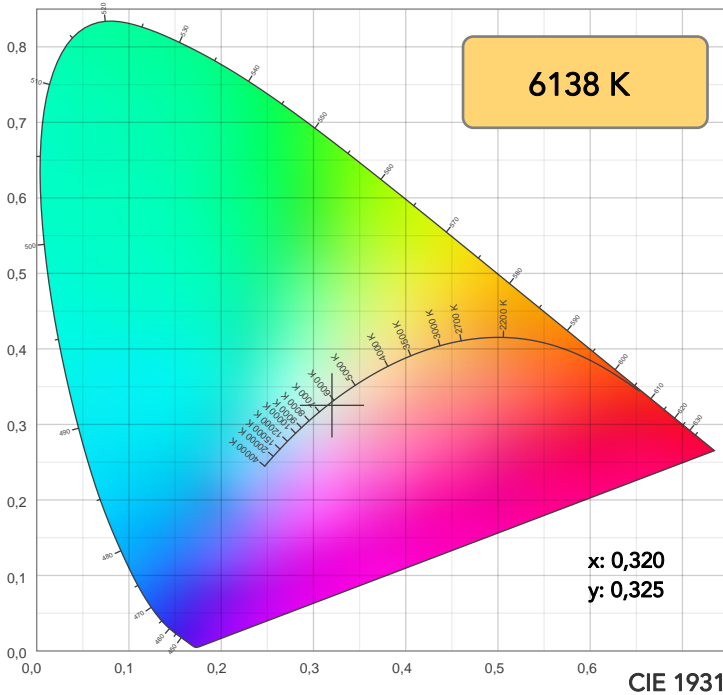

TM30: 88,5

CRI: 91,2 (R1-R8)

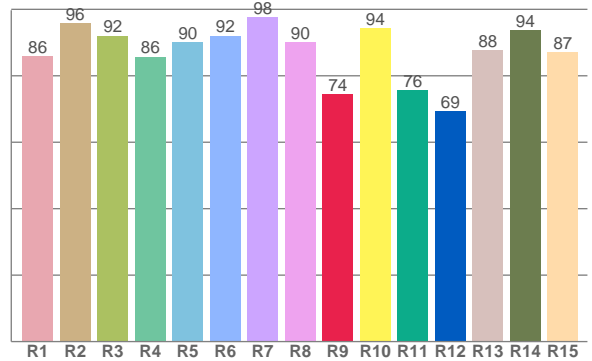
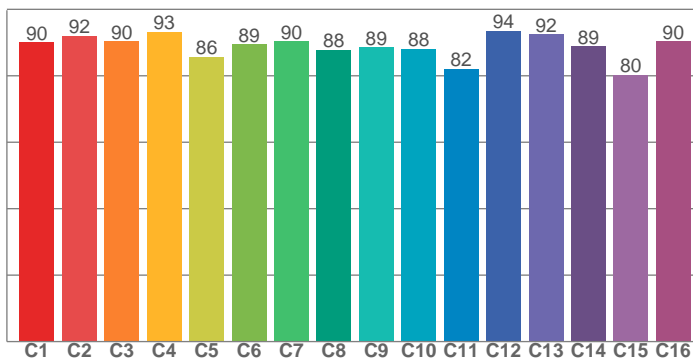

CRI R values, only R1-R8 are used to calculate final CRI value

R1	R2	R3	R4	R5	R6	R7	R8	R9	R10	R11	R12	R13	R14	R15
85,9	95,8	92,0	85,7	90,1	92,0	97,5	90,1	74,5	94,4	75,6	69,3	87,6	93,7	87,2

TM30 C values, 16 binned values out of total of 99 C values

C1	C2	C3	C4	C5	C6	C7	C8	C9	C10	C11	C12	C13	C14	C15	C16
90,0	91,9	90,4	93,3	85,7	89,4	90,4	87,8	88,5	88,1	82,1	93,6	92,4	88,8	80,3	90,4

CQS Q values

Q1	Q2	Q3	Q4	Q5	Q6	Q7	Q8	Q9	Q10	Q11	Q12	Q13	Q14	Q15
93,4	99,4	87,0	92,6	99,4	96,9	98,7	95,1	93,1	97,3	95,2	93,9	95,1	94,3	93,6

CQS: 94,1

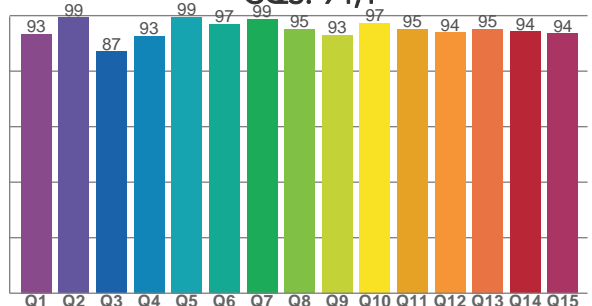

COLOR PARAMETERS

Color temperature	Color rendering index	Red component	Color fidelity	Color gamut	Color quality scale	Television lighting index	Color coordinate cie 1931	Color coordinate cie 1931	Color deviation from black body
CCT	CRI	CRI R9	TM30 Rf	TM30 Rg	CQS	TLCI	x	y	Δuv
6138 K	91,2	74,5	88,5	104,9	94,1	93	0,320	0,325	-0,0057

# TM30 DETAILS

**Rf 88,5**  
Fidelity index Rf

**Rg 104,9**  
Gammut index

Hue Bin	R <sub>f</sub>	Graphic shifts (%)	
		Chroma	Hue
1	90	3%	1%
2	92	4%	-1%
3	90	2%	-3%
4	93	-2%	-2%
5	86	-6%	-1%
6	89	2%	5%
7	90	5%	3%
8	88	2%	5%
9	89	1%	8%
10	88	1%	6%
11	82	5%	9%
12	94	3%	1%
13	92	4%	0%
14	89	2%	4%
15	80	13%	-5%
16	90	3%	3%

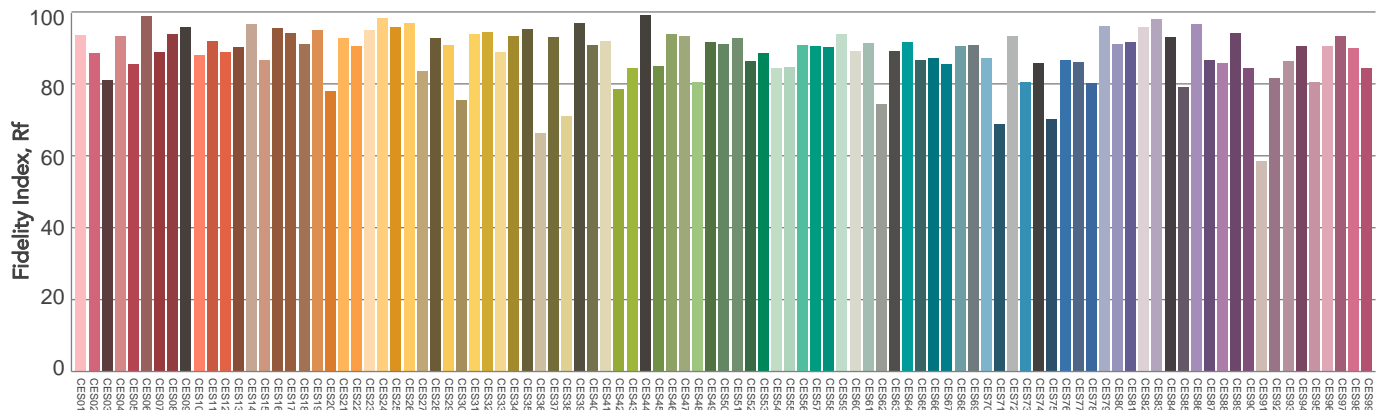
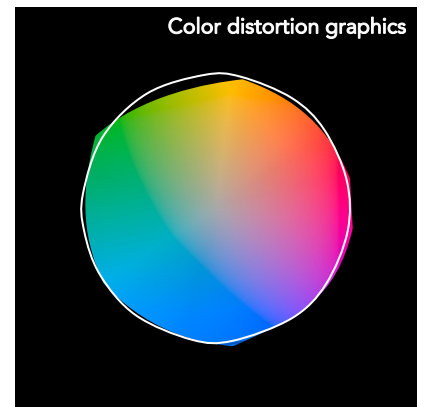
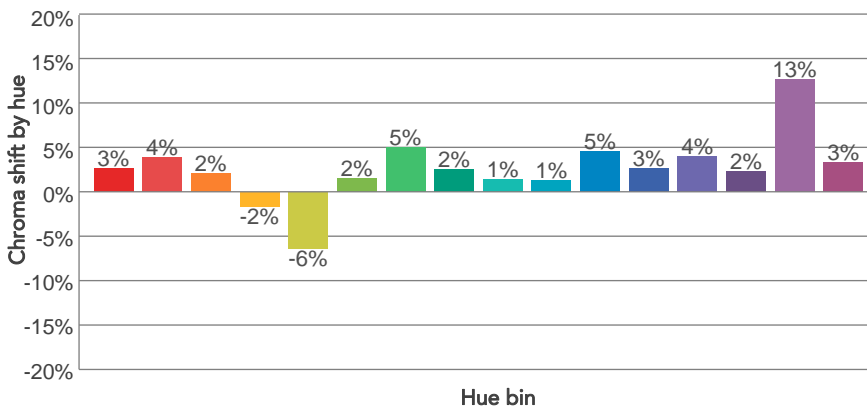
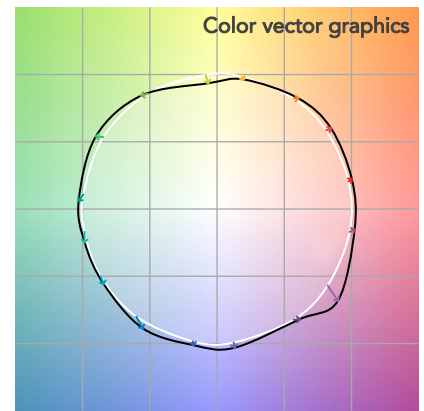
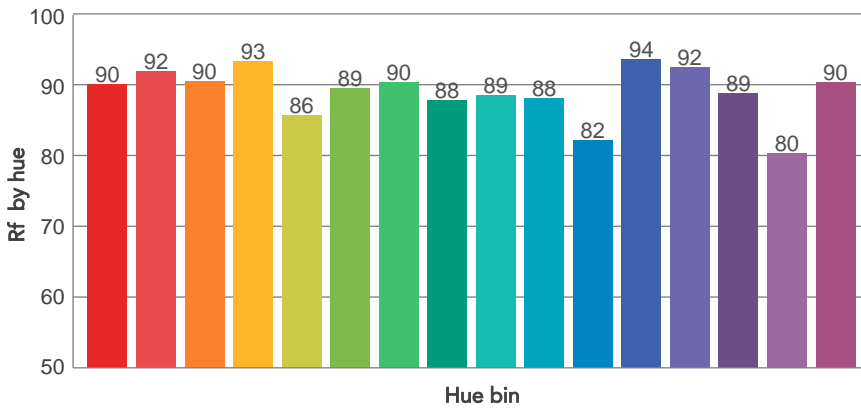
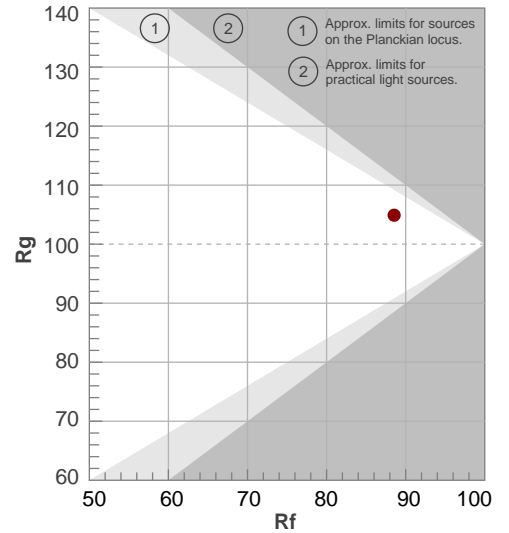

Color Evaluation Sample

# BEAM DETAILS



Beam angle 50%	Field angle 10%	Cut off angle 2,5%	Intensity ratio in 120° cone	Intensity ratio in 90° cone
111°	161,2°	177,6°	77,5%	52,9%

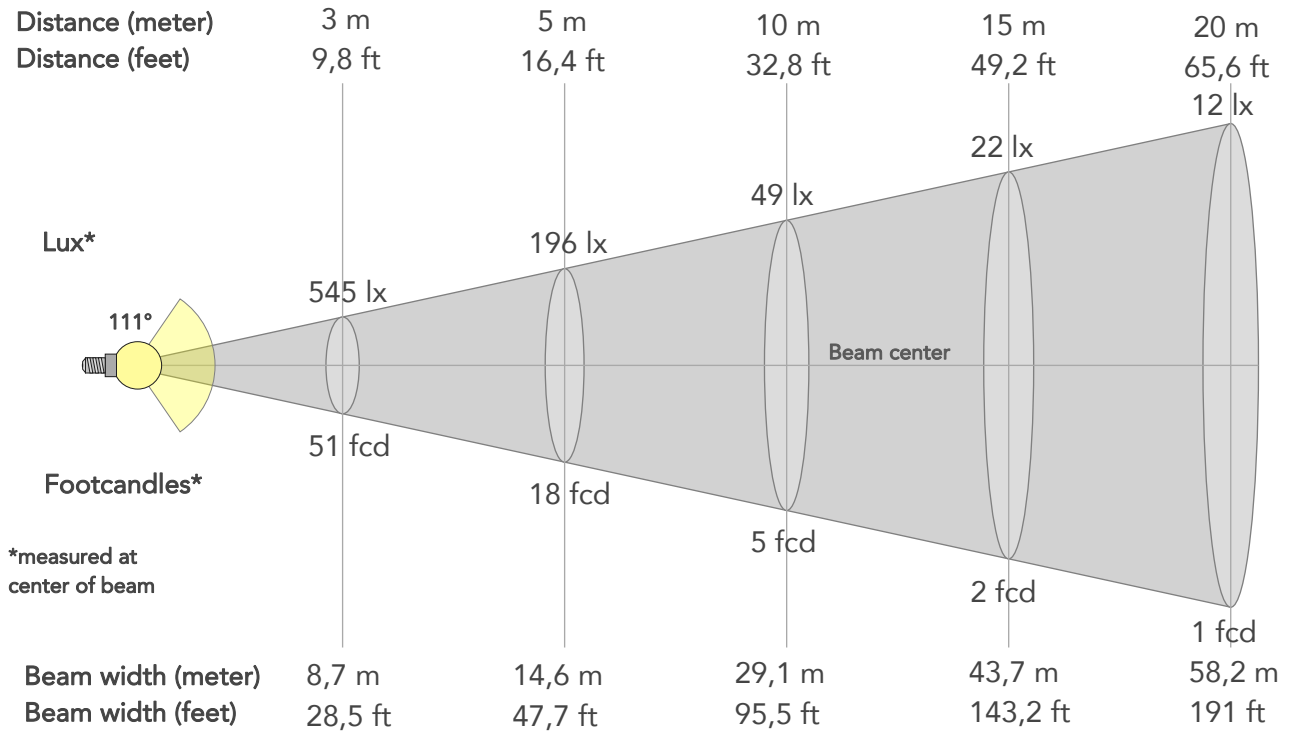

## BEAM INTENSITIES AND WIDTHS

Distance	1m	2m	3m	4m	5m	7,5m	10m	15m	20m	25m	30m	40m	50m
Distance	3,3ft	6,6ft	9,8ft	13,1ft	16,4ft	24,6ft	32,8ft	49,2ft	65,6ft	82ft	98,4ft	131,2ft	164ft
Lux	4909lx	1227lx	545lx	307lx	196lx	87lx	49lx	22lx	12lx	8lx	5lx	3lx	2lx
Footcand.	456fcd	114fcd	51fcd	29fcd	18fcd	8fcd	5fcd	2fcd	1fcd	1fcd	1fcd	0fcd	0fcd
Beam wid.	2,9m	5,8m	8,7m	11,6m	14,6m	21,8m	29,1m	43,7m	58,2m	72,8m	87,3m	116,5m	145,6m
Beam wid.	9,6ft	19,2ft	28,5ft	38,1ft	47,7ft	71,6ft	95,5ft	143,2ft	191ft	238,7ft	286,5ft	382ft	477,5ft

## LINEAR DISTRIBUTION DIAGRAM

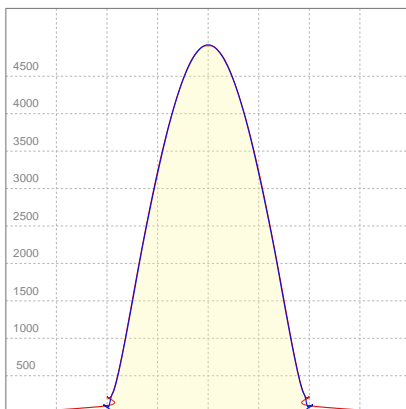

## ELECTRICAL SPECIFICATIONS

Input voltage	Input current	Input power	Effeciency
225V	1,03A	228W	62lm/W



## ISO CANDELA DIAGRAM

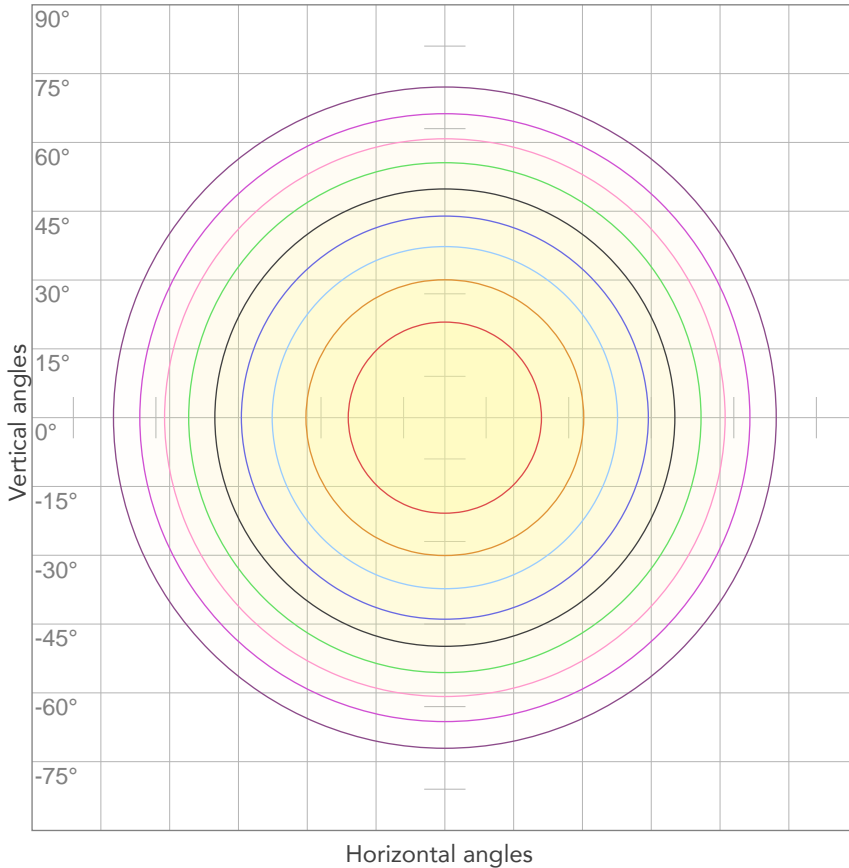

10%	491 cd
20%	982 cd
30%	1473 cd
40%	1963 cd
50%	2454 cd
60%	2945 cd
70%	3436 cd
80%	3927 cd

Conditions:

Number of c-planes: 4

Candela at center: 4909 cd

## ISO LUX DIAGRAM

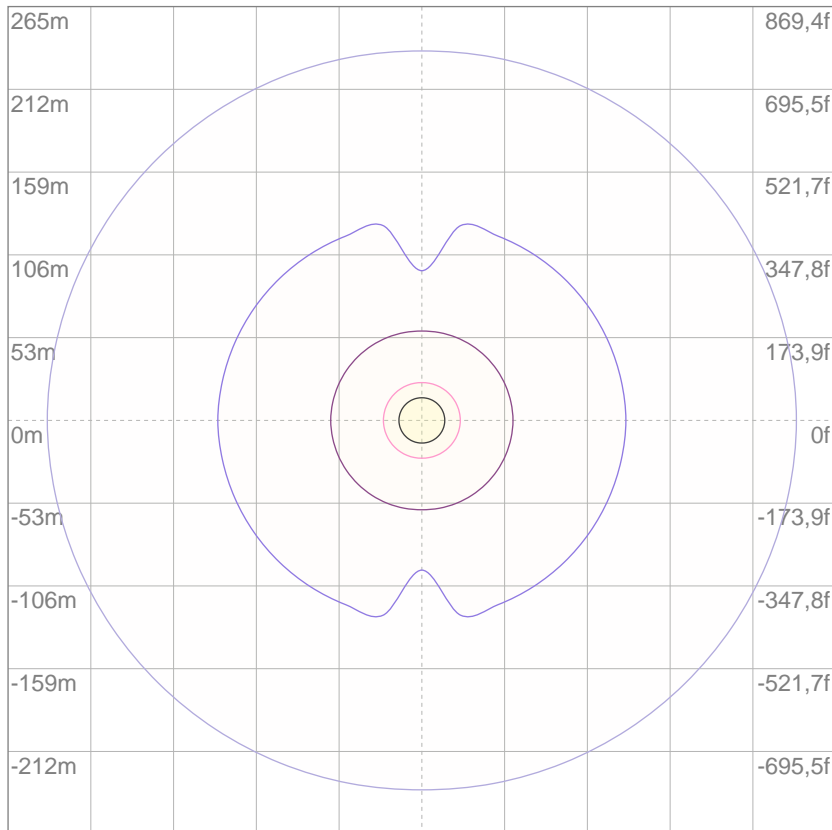

Mounting height: 10 meters (33 feet)

3%	1,47 lx
5%	2,45 lx
10%	4,91 lx
30%	14,7 lx
50%	24,5 lx

Conditions:

Number of c-planes: 4

Lux at center: 49,1 lx

*Lux distribution on a surface when lamp is mounted at 10 meters from the surface.*



Total lumen output:

16789 lm

Peak candela output:

6364 cd

Light quality:

CRI: 93,6

Color temperature:

5847 K

**PRODUCT NAME:**

ECLPANEL TWCJR

**MEASUREMENT CONDITIONS:**

Beam angle:

Filter MD

Target:

5600K

Operator:

Paolo Carvone

Date and time:

14/05/2020 16:09:24

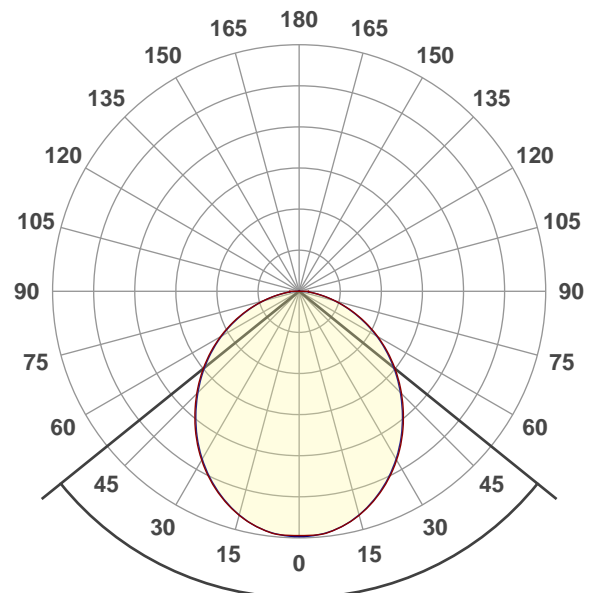

Beam angle 50%: 102,2°

Field angle 10%: 158,3°

Cut off angle 2.5%: 176,9°

Spectra

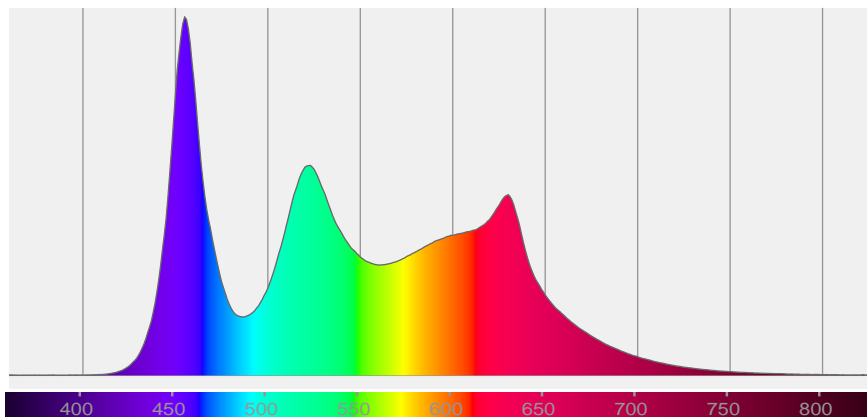

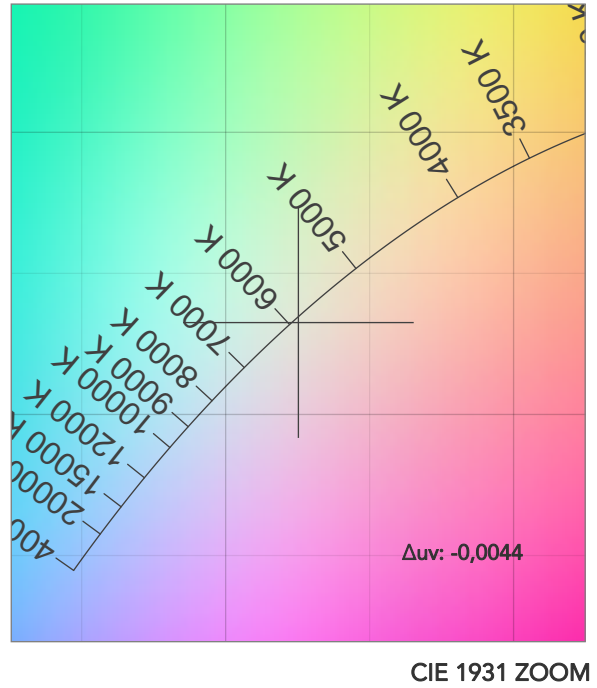
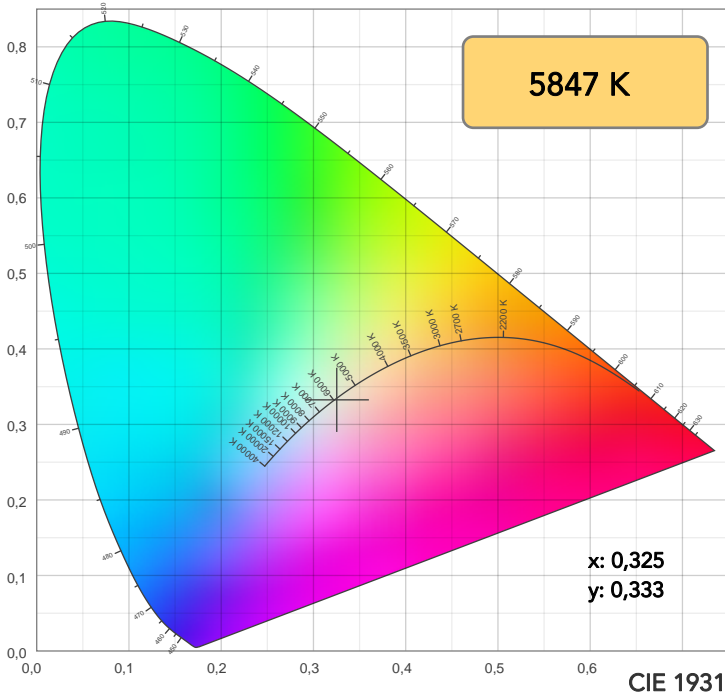

TM30: 89,4

CRI: 93,6 (R1-R8)

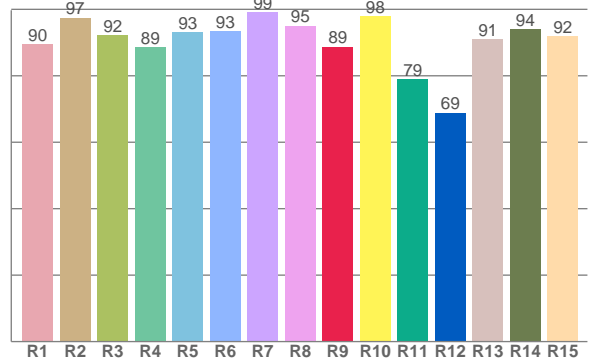
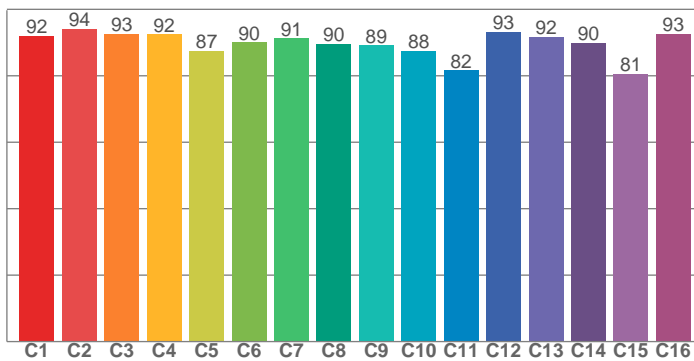

CRI R values, only R1-R8 are used to calculate final CRI value

R1	R2	R3	R4	R5	R6	R7	R8	R9	R10	R11	R12	R13	R14	R15
89,5	97,5	92,2	88,5	93,1	93,4	99,2	95,1	88,8	98,0	78,9	68,9	91,0	94,0	91,9

TM30 C values, 16 binned values out of total of 99 C values

C1	C2	C3	C4	C5	C6	C7	C8	C9	C10	C11	C12	C13	C14	C15	C16
92,0	94,1	92,7	92,5	87,4	90,0	91,2	89,7	89,2	87,5	81,6	93,3	91,8	89,9	80,5	92,6

CQS Q values

Q1	Q2	Q3	Q4	Q5	Q6	Q7	Q8	Q9	Q10	Q11	Q12	Q13	Q14	Q15
93,7	99,3	86,2	91,3	98,9	96,5	97,6	96,8	93,7	96,1	97,1	95,9	96,7	95,2	95,4

CQS: 94,4

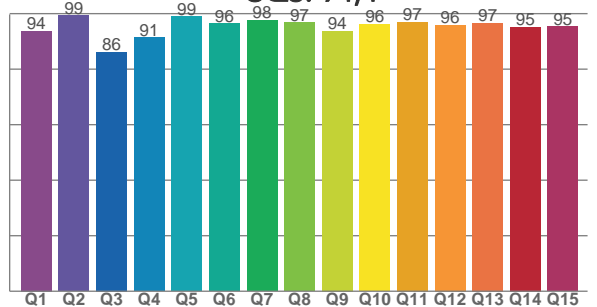

COLOR PARAMETERS

Color temperature	Color rendering index	Red component	Color fidelity	Color gamut	Color quality scale	Television lighting index	Color coordinate cie 1931	Color coordinate cie 1931	Color deviation from black body
CCT	CRI	CRI R9	TM30 Rf	TM30 Rg	CQS	TLCI	x	y	Δuv
5847 K	93,6	88,8	89,4	104,0	94,4	92	0,325	0,333	-0,0044

# TM30 DETAILS

**Rf 89,4**  
Fidelity index Rf

**Rg 104,0**  
Gammut index

Hue Bin	R <sub>f</sub>	Graphic shifts (%)	
		Chroma	Hue
1	92	1%	1%
2	94	3%	0%
3	93	1%	-1%
4	92	-3%	-2%
5	87	-5%	0%
6	90	2%	4%
7	91	5%	2%
8	90	2%	4%
9	89	0%	7%
10	88	1%	7%
11	82	4%	9%
12	93	3%	1%
13	92	4%	-1%
14	90	3%	3%
15	81	11%	-8%
16	93	2%	2%

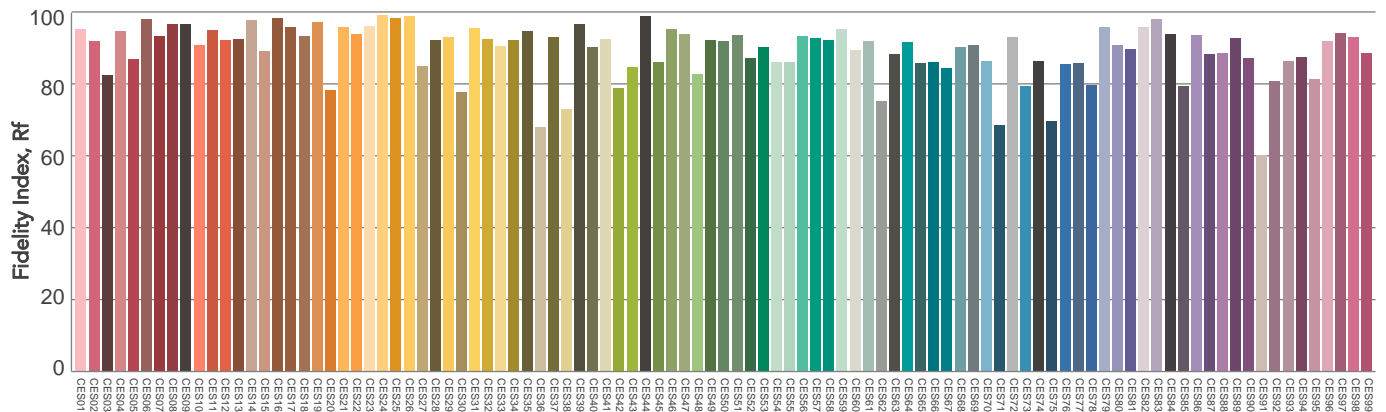
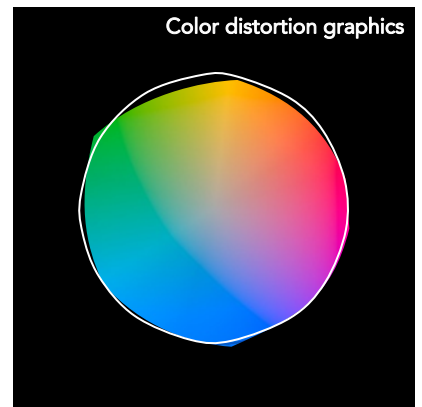
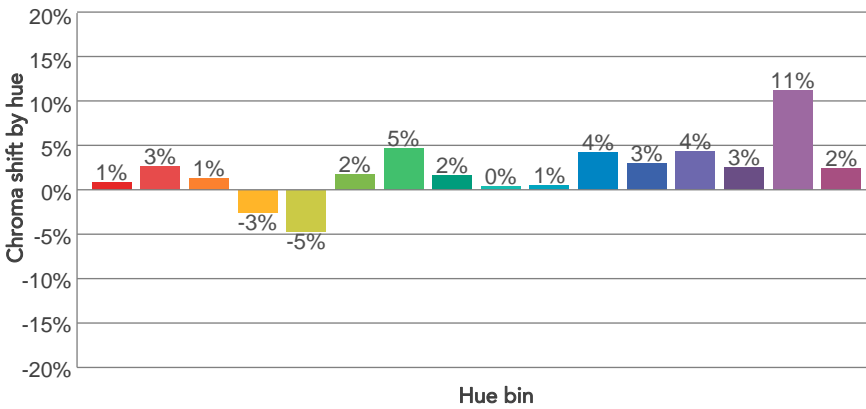
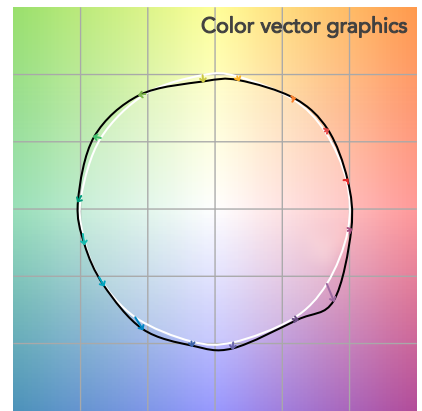
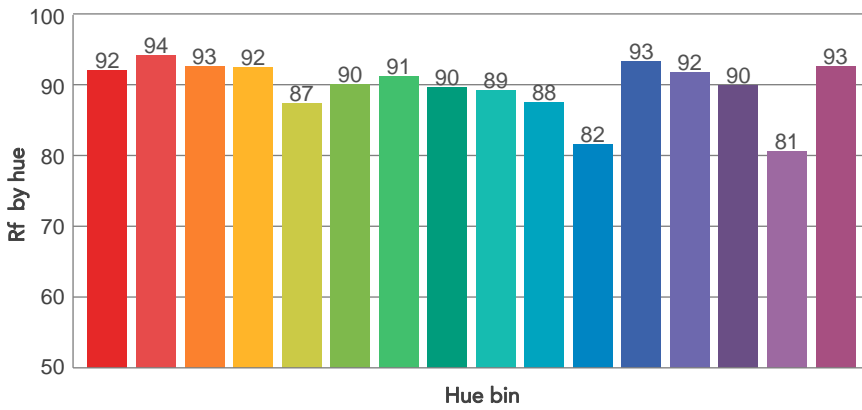
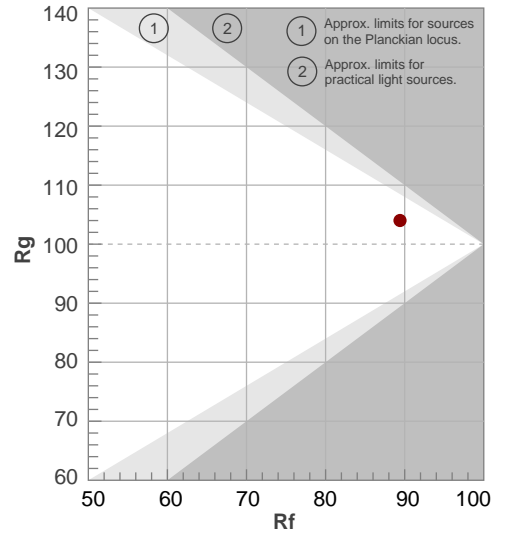

Color Evaluation Sample

# BEAM DETAILS



Beam angle 50%	Field angle 10%	Cut off angle 2,5%	Intensity ratio in 120° cone	Intensity ratio in 90° cone
102,2°	158,3°	176,9°	77,9%	54,5%

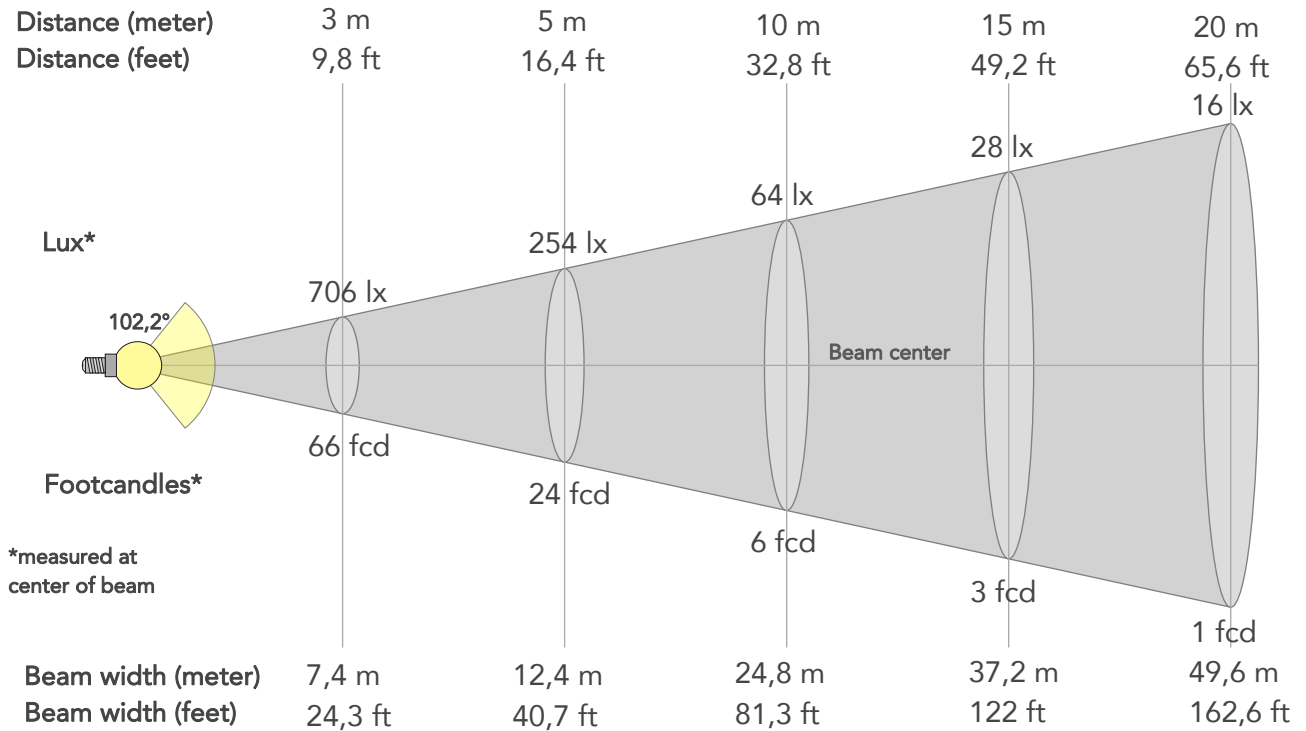

## BEAM INTENSITIES AND WIDTHS

Distance	1m	2m	3m	4m	5m	7,5m	10m	15m	20m	25m	30m	40m	50m
Distance	3,3ft	6,6ft	9,8ft	13,1ft	16,4ft	24,6ft	32,8ft	49,2ft	65,6ft	82ft	98,4ft	131,2ft	164ft
Lux	6354lx	1588lx	706lx	397lx	254lx	113lx	64lx	28lx	16lx	10lx	7lx	4lx	3lx
Footcand.	590fcd	148fcd	66fcd	37fcd	24fcd	10fcd	6fcd	3fcd	1fcd	1fcd	1fcd	0fcd	0fcd
Beam wid.	2,5m	5m	7,4m	9,9m	12,4m	18,6m	24,8m	37,2m	49,6m	62m	74,4m	99,1m	123,9m
Beam wid.	8,2ft	16,4ft	24,3ft	32,5ft	40,7ft	61ft	81,3ft	122ft	162,6ft	203,3ft	243,9ft	325,2ft	406,5ft

## LINEAR DISTRIBUTION DIAGRAM

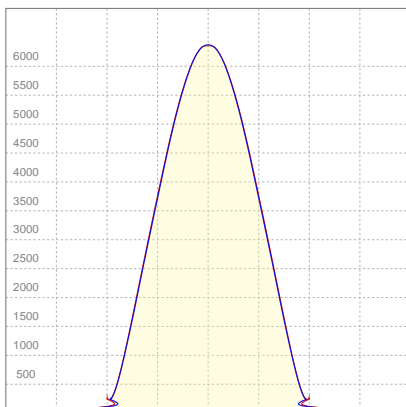

## ELECTRICAL SPECIFICATIONS

Input voltage	Input current	Input power	Effeciency
225V	1,03A	228,1W	74lm/W

## ISO CANDELA DIAGRAM

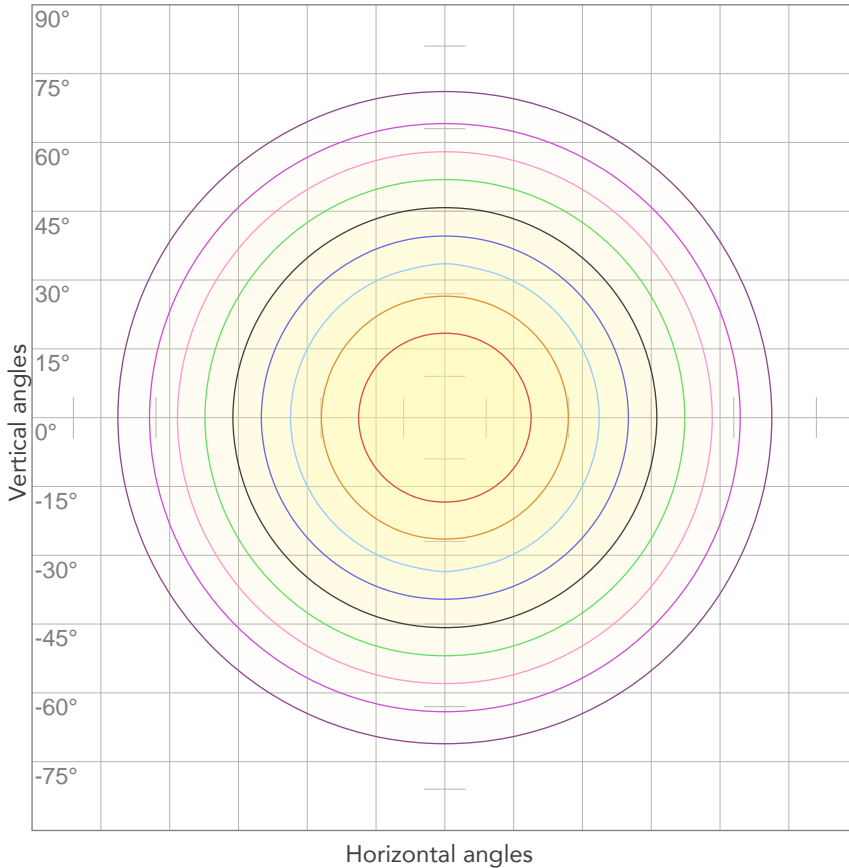

10%	635 cd
20%	1271 cd
30%	1906 cd
40%	2541 cd
50%	3177 cd
60%	3812 cd
70%	4448 cd
80%	5083 cd

**Conditions:**

Number of c-planes: 4

Candela at center: 6354 cd

## ISO LUX DIAGRAM

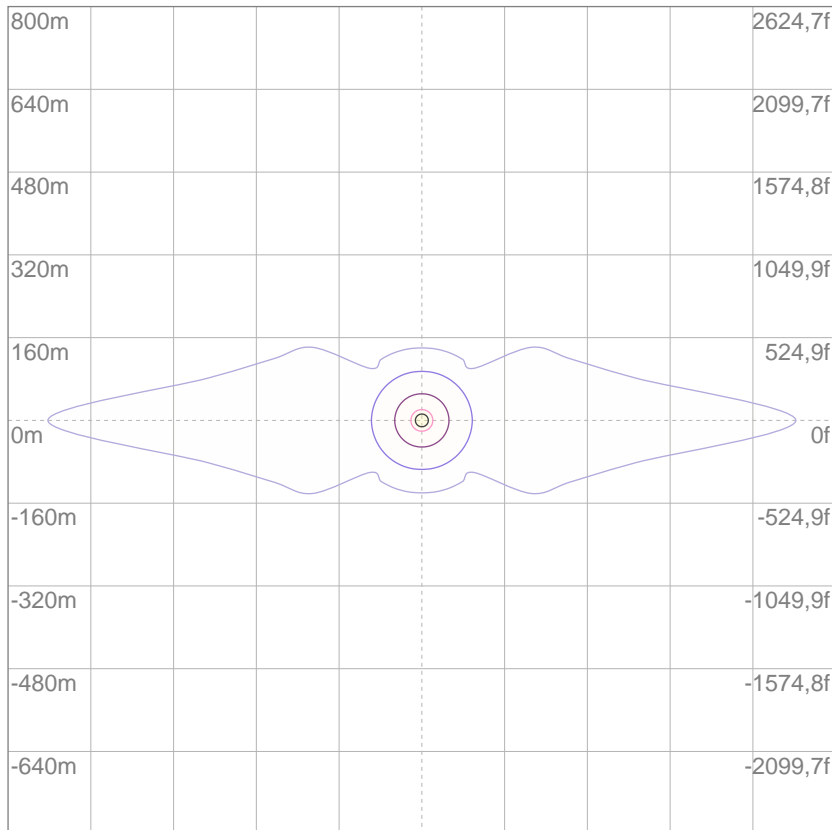

Mounting height: 10 meters (33 feet)

3%	1,91 lx
5%	3,18 lx
10%	6,35 lx
30%	19,1 lx
50%	31,8 lx

**Conditions:**

Number of c-planes: 4

Lux at center: 63,5 lx

*Lux distribution on a surface when lamp is mounted at 10 meters from the surface.*



Total lumen output:

16811 lm

Peak candela output:

6499 cd

Light quality:

CRI: 93,5

Color temperature:

5895 K

**PRODUCT NAME:**

ECLPANEL TWCJR

**MEASURAMENT CONDITIONS:**

Beam angle:

Filter LD

Target:

5600K

Operator:

Paolo Carvone

Date and time:

14/05/2020 15:53:09

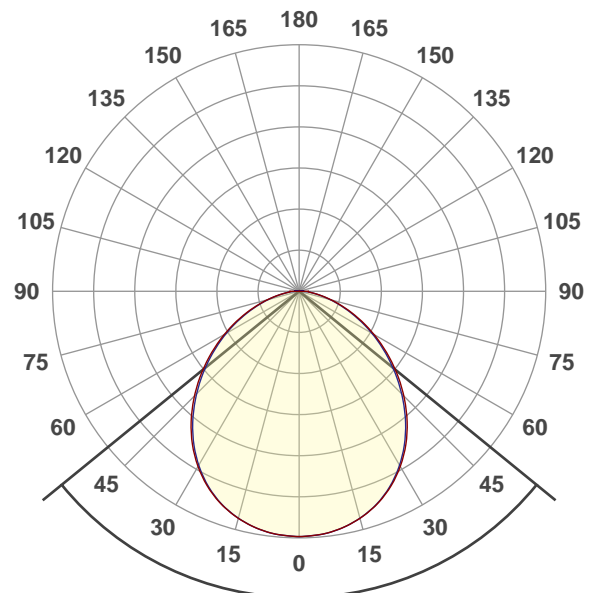

Beam angle 50%: 101,6°

Field angle 10%: 155,9°

Cut off angle 2.5%: 177°

Spectra

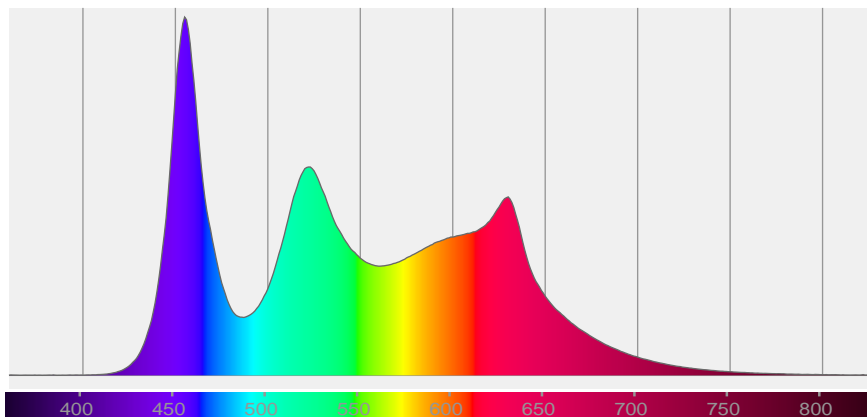

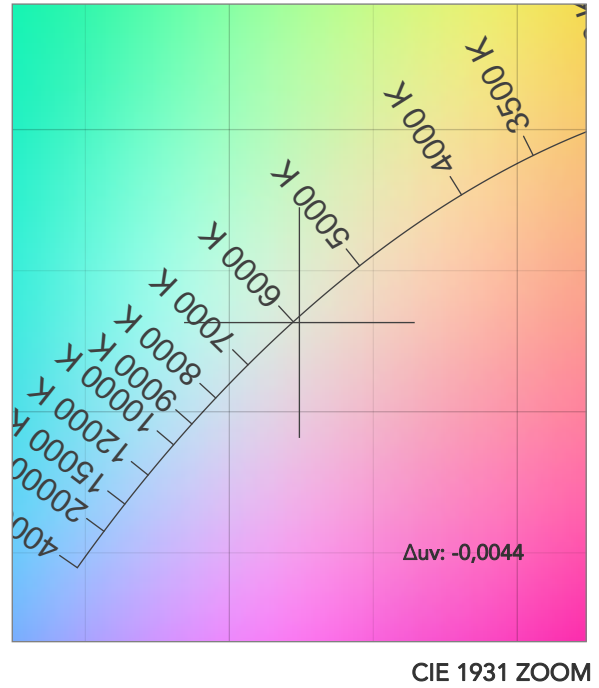
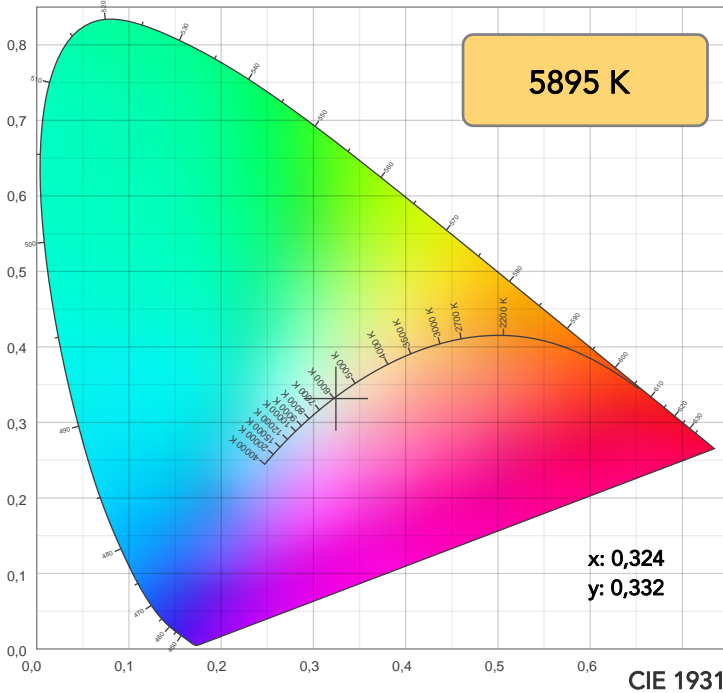

TM30: 89,4

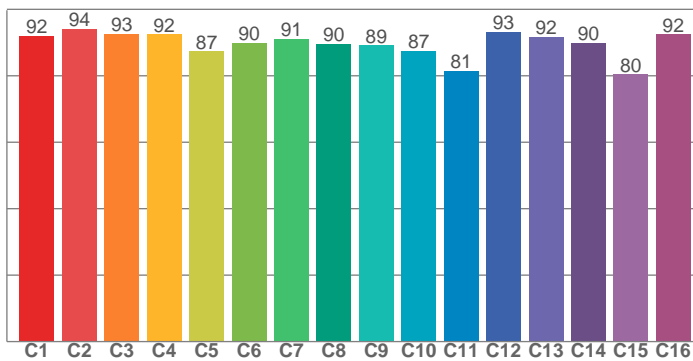

CRI: 93,5 (R1-R8)

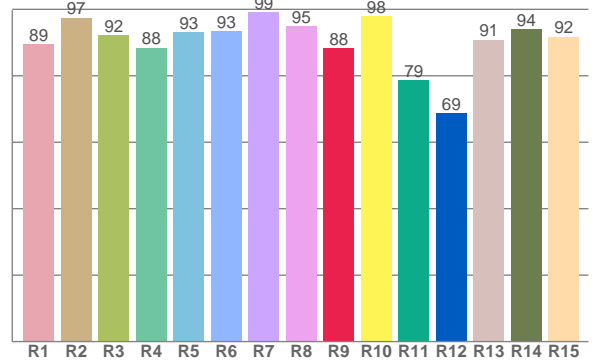

CRI R values, only R1-R8 are used to calculate final CRI value

R1	R2	R3	R4	R5	R6	R7	R8	R9	R10	R11	R12	R13	R14	R15
89,4	97,5	92,1	88,4	93,1	93,4	99,2	95,0	88,4	97,9	78,8	68,8	90,9	94,0	91,7

TM30 C values, 16 binned values out of total of 99 C values

C1	C2	C3	C4	C5	C6	C7	C8	C9	C10	C11	C12	C13	C14	C15	C16
92,0	94,0	92,6	92,4	87,4	90,0	91,2	89,6	89,2	87,4	81,5	93,3	91,8	89,9	80,5	92,5

CQS Q values

Q1	Q2	Q3	Q4	Q5	Q6	Q7	Q8	Q9	Q10	Q11	Q12	Q13	Q14	Q15
93,7	99,3	86,1	91,3	98,9	96,5	97,7	96,7	93,7	96,1	97,1	95,9	96,7	95,2	95,4

CQS: 94,4

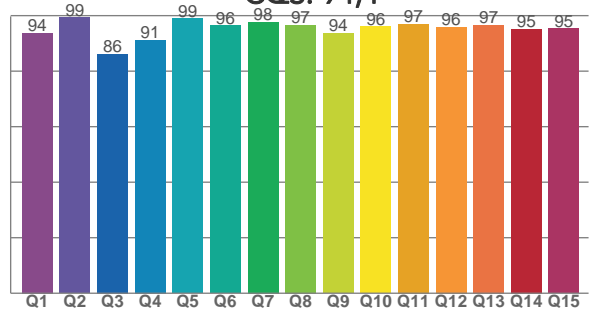

COLOR PARAMETERS

Color temperature	Color rendering index	Red component	Color fidelity	Color gamut	Color quality scale	Television lighting index	Color coordinate cie 1931	Color coordinate cie 1931	Color deviation from black body
CCT	CRI	CRI R9	TM30 Rf	TM30 Rg	CQS	TLCI	x	y	Δuv
5895 K	93,5	88,4	89,4	104,0	94,4	92	0,324	0,332	-0,0044



# TM30 DETAILS

**Rf 89,4**  
Fidelity index Rf

**Rg 104,0**  
Gammut index

Hue Bin	R <sub>f</sub>	Graphic shifts (%)	
		Chroma	Hue
1	92	1%	1%
2	94	3%	0%
3	93	1%	-1%
4	92	-3%	-2%
5	87	-5%	0%
6	90	2%	4%
7	91	5%	2%
8	90	2%	4%
9	89	0%	7%
10	87	1%	7%
11	81	4%	9%
12	93	3%	1%
13	92	4%	-1%
14	90	3%	3%
15	80	11%	-7%
16	92	2%	2%

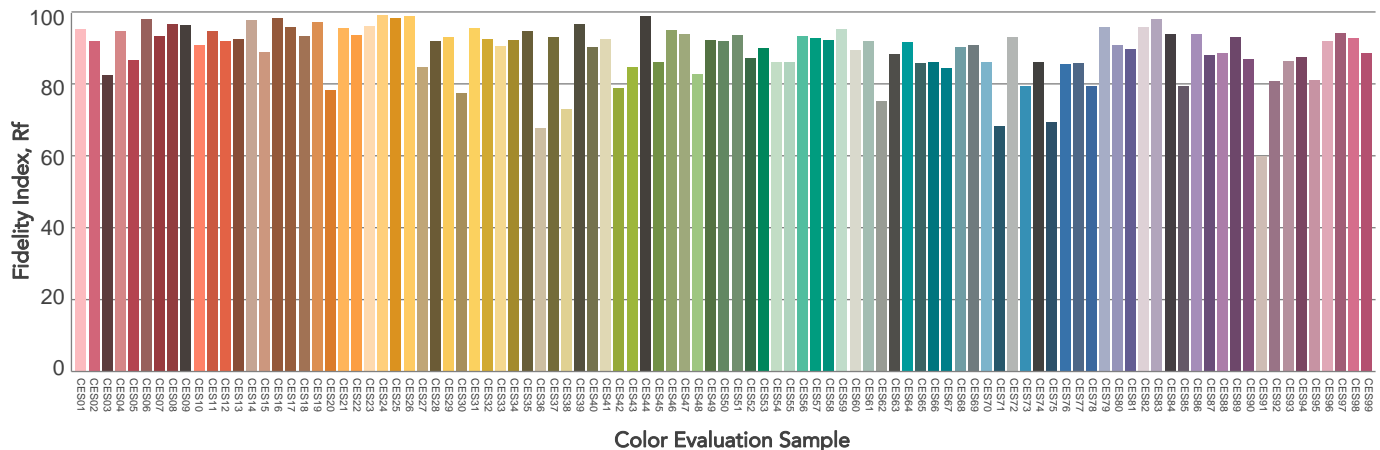
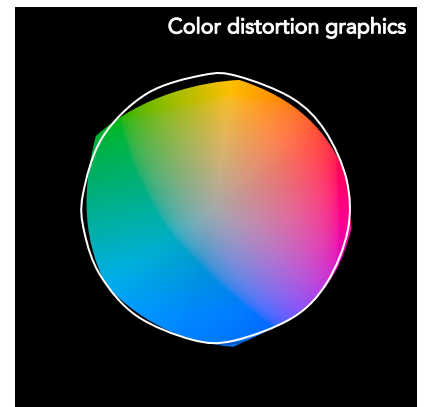
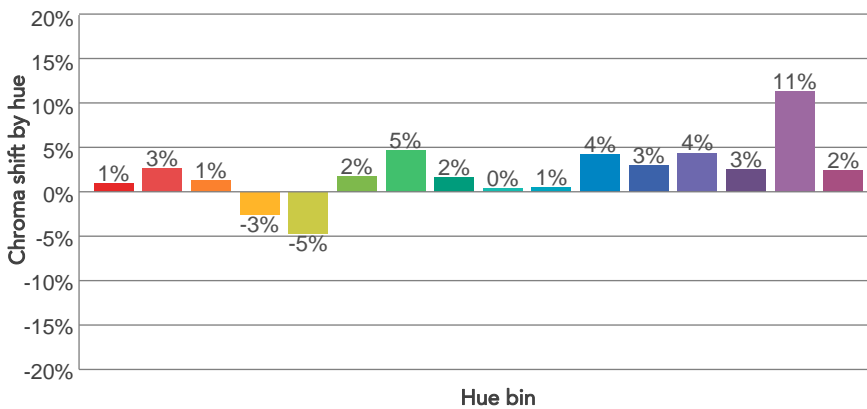
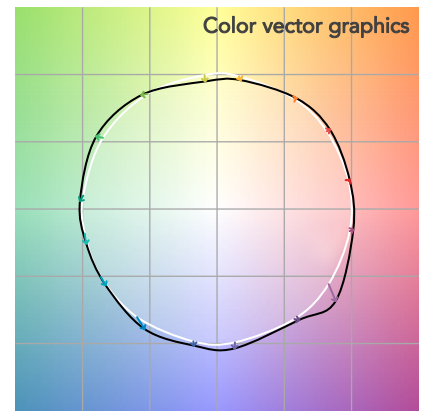
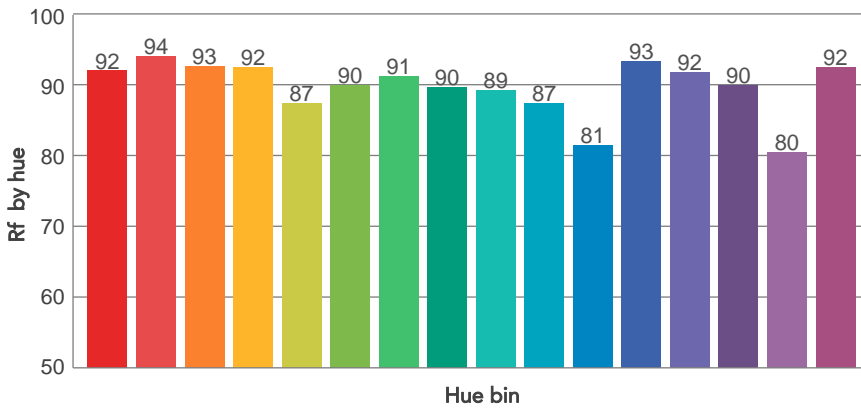
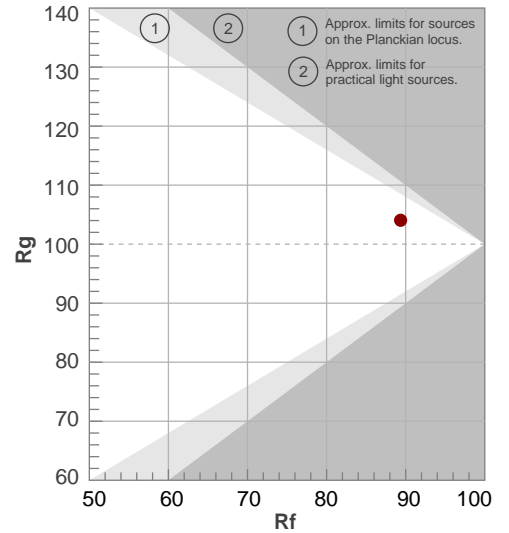

# BEAM DETAILS



Beam angle 50%	Field angle 10%	Cut off angle 2,5%	Intensity ratio in 120° cone	Intensity ratio in 90° cone
101,6°	155,9°	177°	80,7%	57,1%

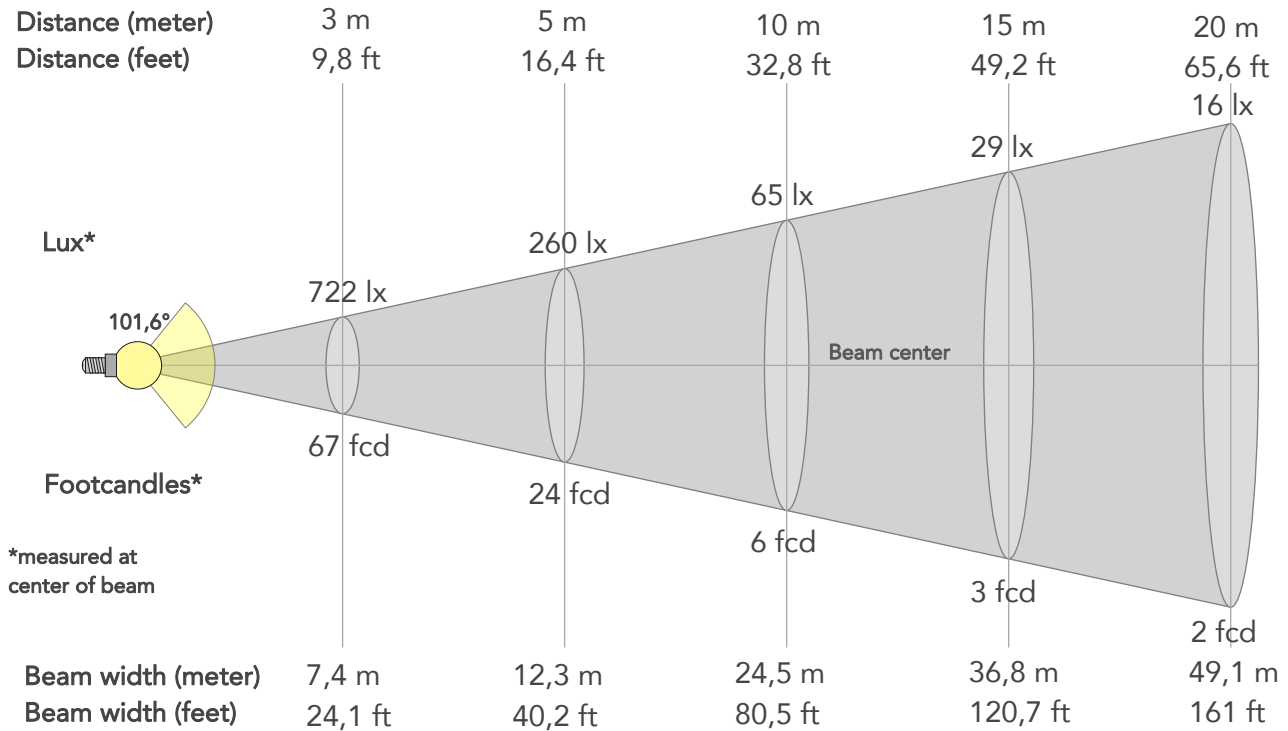

## BEAM INTENSITIES AND WIDTHS

Distance	1m	2m	3m	4m	5m	7,5m	10m	15m	20m	25m	30m	40m	50m
Distance	3,3ft	6,6ft	9,8ft	13,1ft	16,4ft	24,6ft	32,8ft	49,2ft	65,6ft	82ft	98,4ft	131,2ft	164ft
Lux	6499lx	1625lx	722lx	406lx	260lx	116lx	65lx	29lx	16lx	10lx	7lx	4lx	3lx
Footcand.	604fcd	151fcd	67fcd	38fcd	24fcd	11fcd	6fcd	3fcd	2fcd	1fcd	1fcd	0fcd	0fcd
Beam wid.	2,5m	4,9m	7,4m	9,8m	12,3m	18,4m	24,5m	36,8m	49,1m	61,4m	73,6m	98,2m	122,7m
Beam wid.	8,1ft	16,2ft	24,1ft	32,1ft	40,2ft	60,4ft	80,5ft	120,7ft	161ft	201,2ft	241,5ft	322ft	402,5ft

## LINEAR DISTRIBUTION DIAGRAM

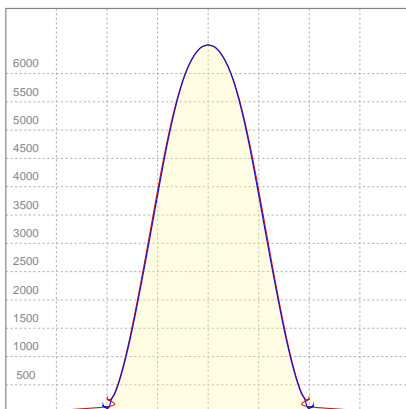

## ELECTRICAL SPECIFICATIONS

Input voltage	Input current	Input power	Effeciency
225V	1,03A	227,8W	74lm/W

## ISO CANDELA DIAGRAM

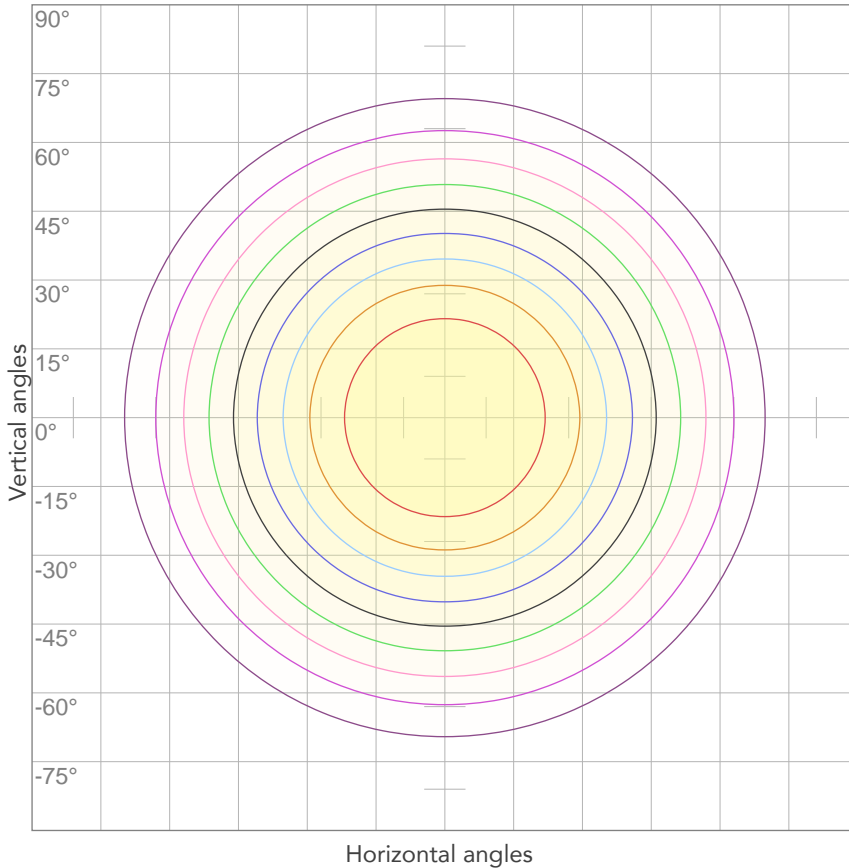

10%	650 cd
20%	1300 cd
30%	1950 cd
40%	2600 cd
50%	3250 cd
60%	3899 cd
70%	4549 cd
80%	5199 cd

Conditions:

Number of c-planes: 4

Candela at center: 6499 cd

## ISO LUX DIAGRAM

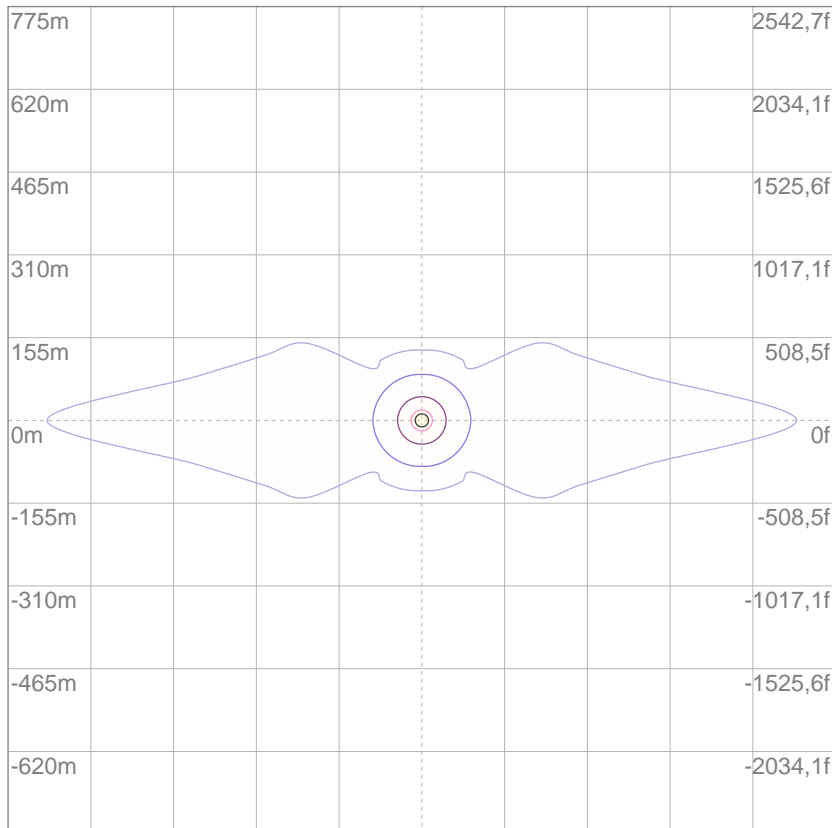

3%	1,95 lx
5%	3,25 lx
10%	6,50 lx
30%	19,5 lx
50%	32,5 lx

Conditions:

Number of c-planes: 4

Lux at center: 65,0 lx

*Lux distribution on a surface when lamp is mounted at 10 meters from the surface.*

Mounting height: 10 meters (33 feet)



Total lumen output:

14236 lm

Peak candela output:

9296 cd

Light quality:

CRI: 95,3

Color temperature:

5656 K

**PRODUCT NAME:**

ECLPANEL TWCJR

**MEASUREMENT CONDITIONS:**

Beam angle:

Filter INT

Target:

5600K

Operator:

Paolo Carvone

Date and time:

13/11/2020 12:19:00

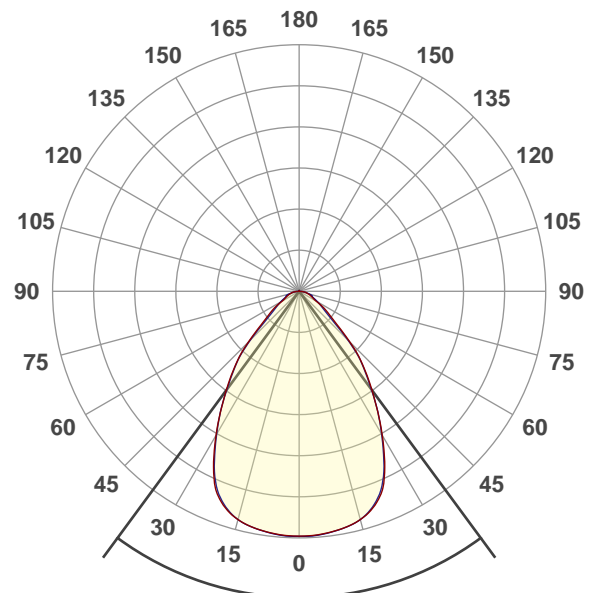

Beam angle 50%: 72,7°

Field angle 10%: 115,7°

Cut off angle 2.5%: 161,3°

Spectra

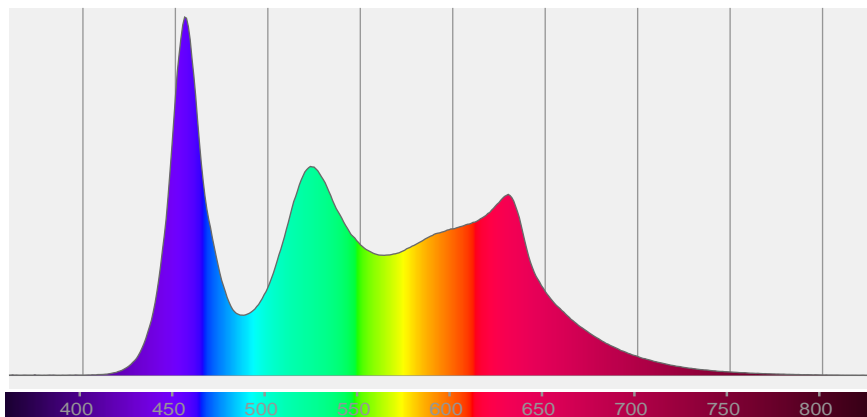

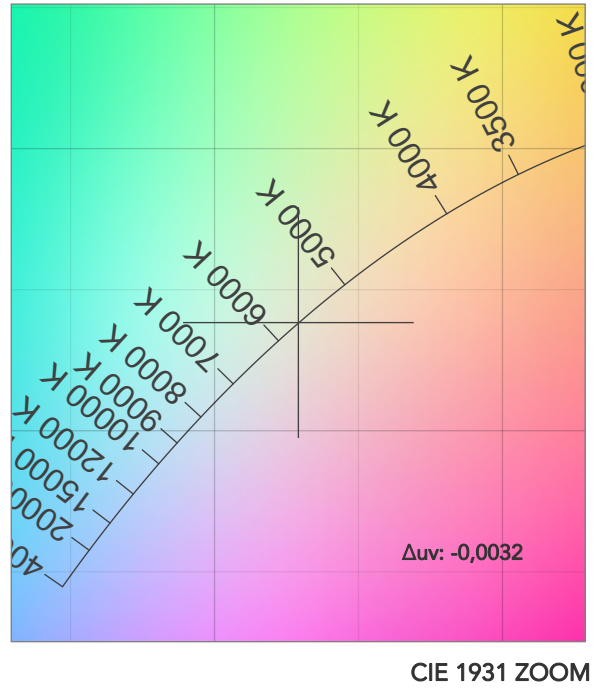
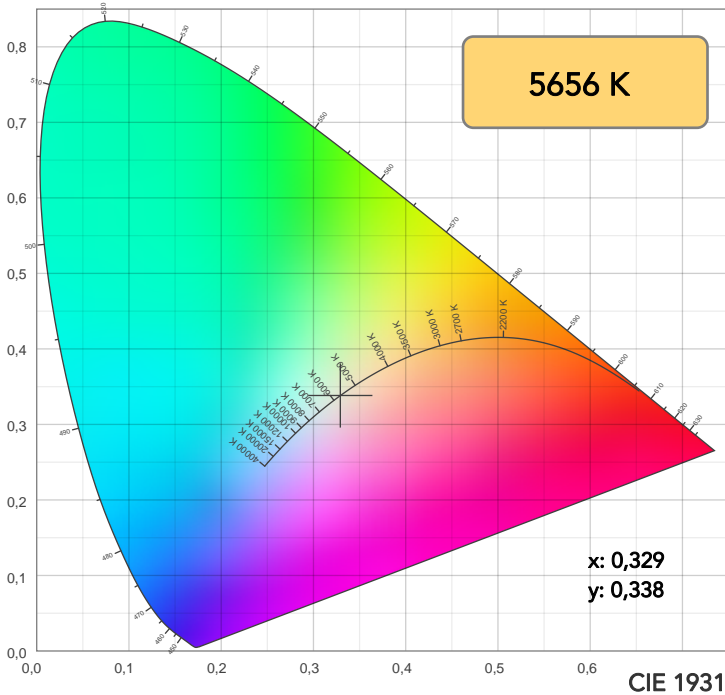

TM30: 89,5

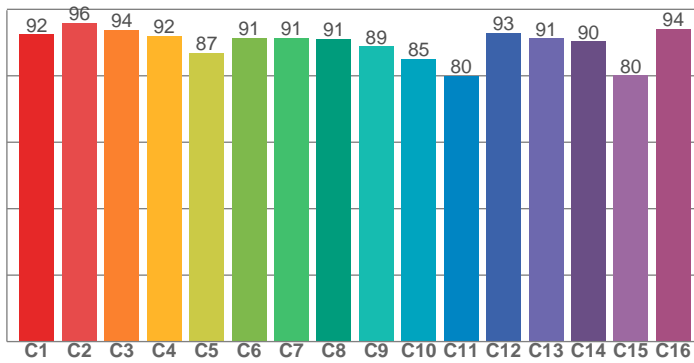

CRI: 95,3 (R1-R8)

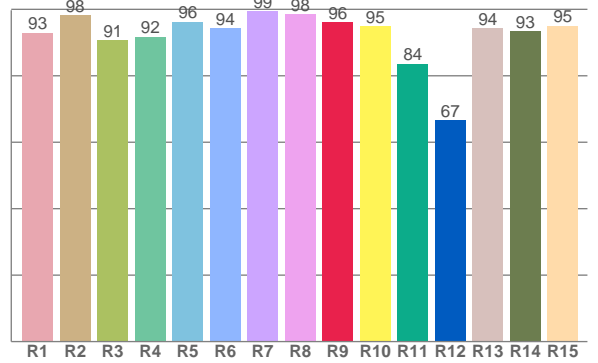

CRI R values, only R1-R8 are used to calculate final CRI value

R1	R2	R3	R4	R5	R6	R7	R8	R9	R10	R11	R12	R13	R14	R15
93,0	98,2	90,7	91,8	96,2	94,2	99,4	98,5	96,1	94,8	83,7	66,6	94,2	93,4	95,0

TM30 C values, 16 binned values out of total of 99 C values

C1	C2	C3	C4	C5	C6	C7	C8	C9	C10	C11	C12	C13	C14	C15	C16
92,4	95,9	93,9	92,0	86,9	91,4	91,4	91,2	88,9	85,0	79,9	92,9	91,3	90,3	80,1	94,2

CQS Q values

Q1	Q2	Q3	Q4	Q5	Q6	Q7	Q8	Q9	Q10	Q11	Q12	Q13	Q14	Q15
93,5	99,1	84,3	88,2	96,6	96,7	95,9	98,4	93,3	94,2	99,7	97,9	97,8	96,1	95,9

CQS: 93,7

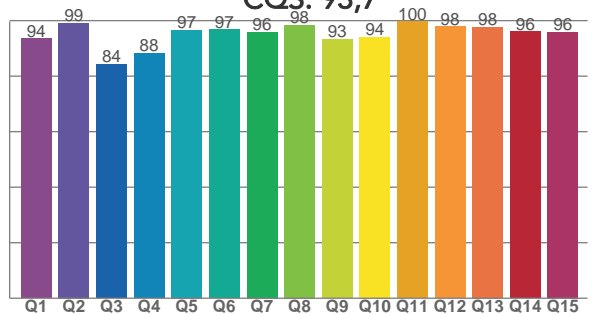

COLOR PARAMETERS

Color temperature	Color rendering index	Red component	Color fidelity	Color gamut	Color quality scale	Television lighting index	Color coordinate cie 1931	Color coordinate cie 1931	Color deviation from black body
CCT	CRI	CRI R9	TM30 Rf	TM30 Rg	CQS	TLCI	x	y	Δuv
5656 K	95,3	96,1	89,5	102,9	93,7	93	0,329	0,338	-0,0032

# TM30 DETAILS

**Rf 89,5**  
Fidelity index Rf

**Rg 102,9**  
Gammut index

Hue Bin	R <sub>f</sub>	Graphic shifts (%)	
		Chroma	Hue
1	92	-1%	1%
2	96	2%	0%
3	94	1%	0%
4	92	-2%	0%
5	87	-4%	1%
6	91	3%	3%
7	91	2%	2%
8	91	0%	4%
9	89	-1%	8%
10	85	0%	8%
11	80	4%	11%
12	93	3%	2%
13	91	5%	-1%
14	90	3%	2%
15	80	11%	-9%
16	94	2%	1%

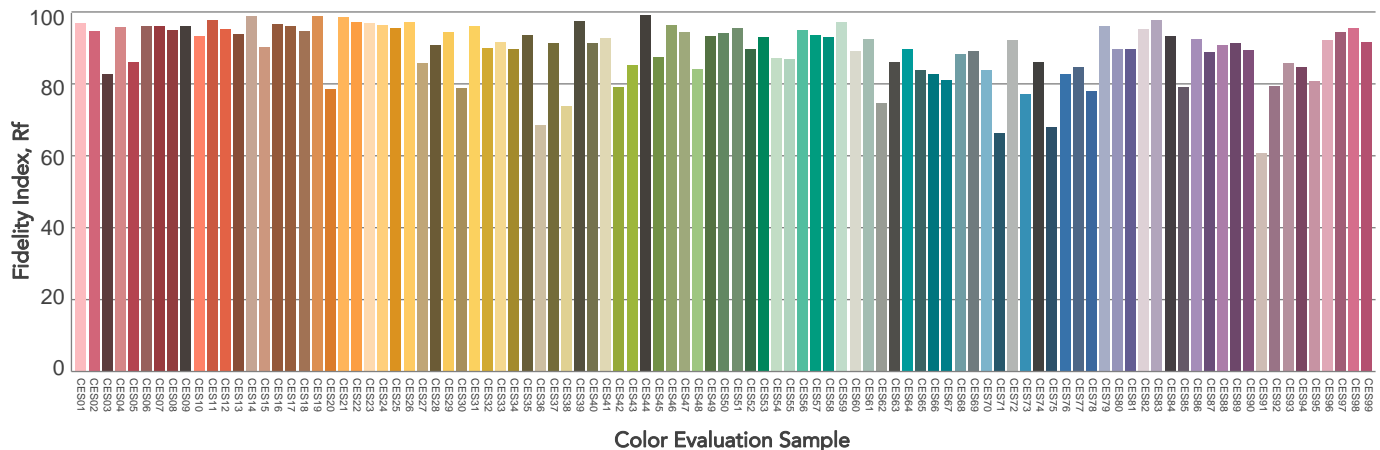
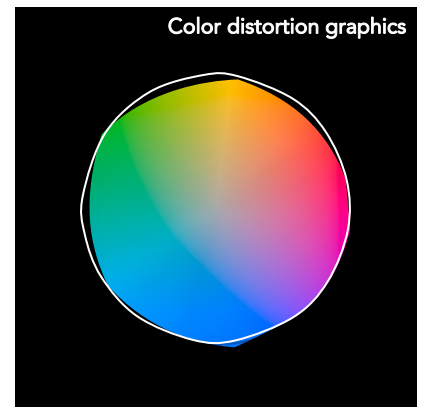
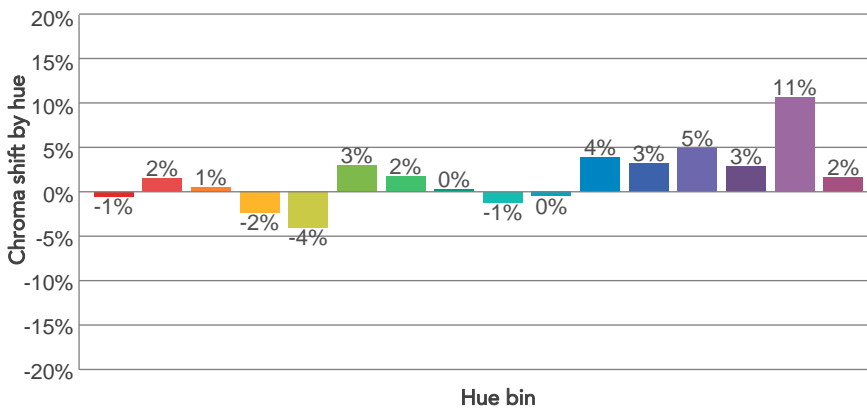
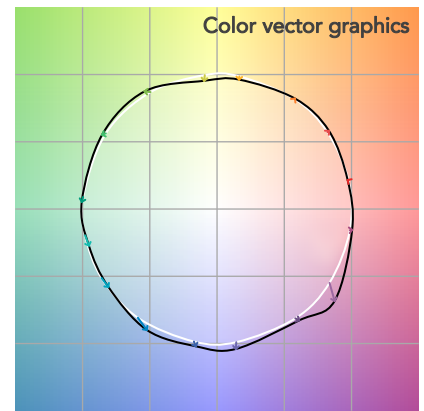
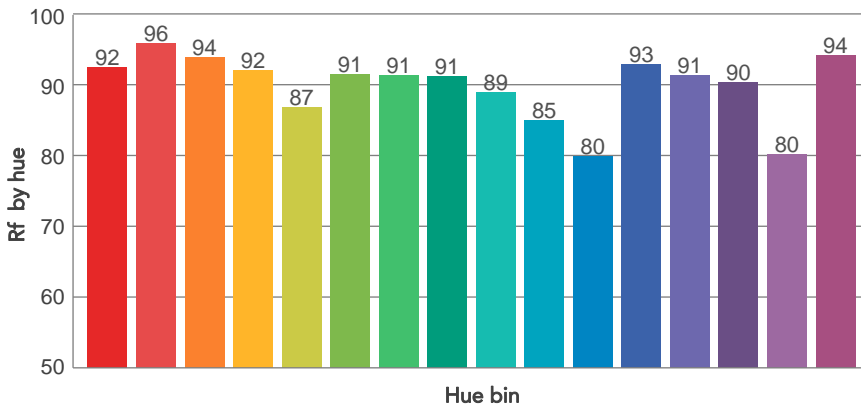
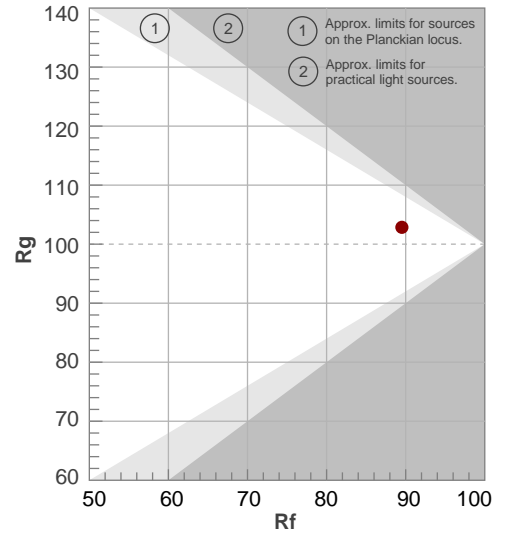

# BEAM DETAILS



Beam angle 50%	Field angle 10%	Cut off angle 2,5%	Intensity ratio in 120° cone	Intensity ratio in 90° cone
72,7°	115,7°	161,3°	91,7%	78,6%

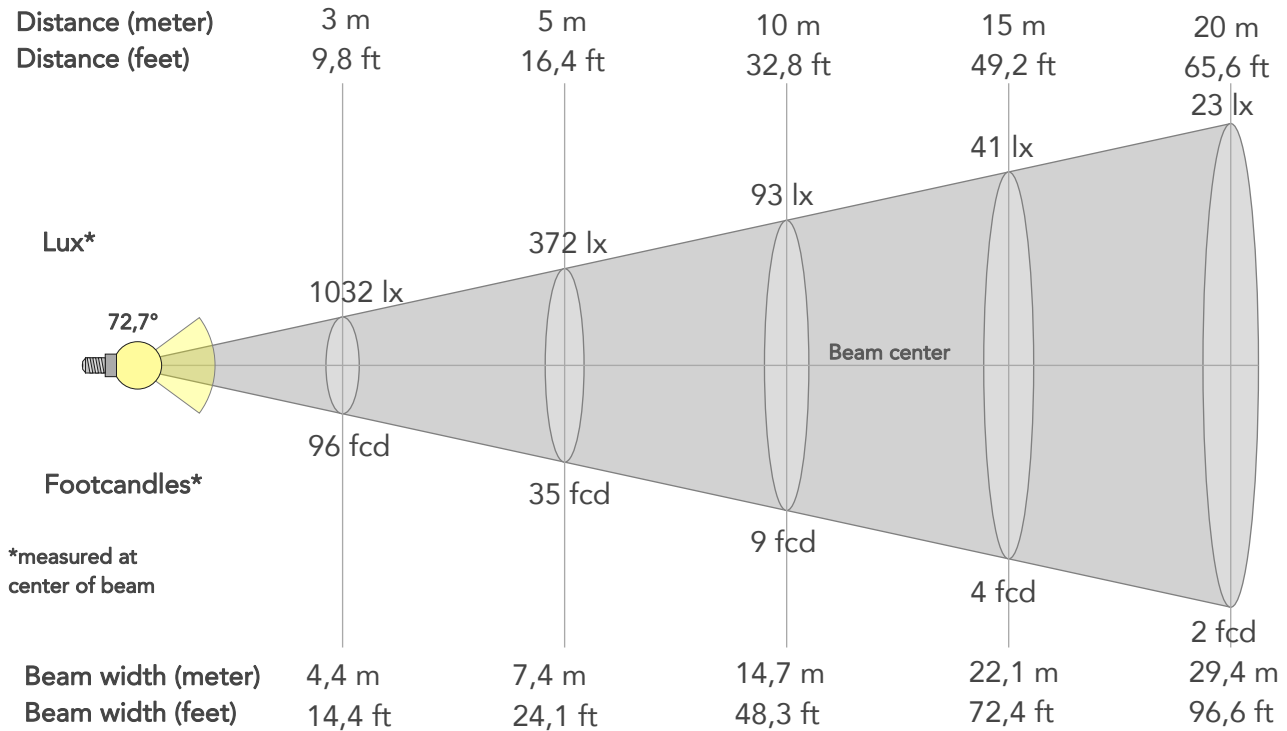

## BEAM INTENSITIES AND WIDTHS

Distance	1m	2m	3m	4m	5m	7,5m	10m	15m	20m	25m	30m	40m	50m
Distance	3,3ft	6,6ft	9,8ft	13,1ft	16,4ft	24,6ft	32,8ft	49,2ft	65,6ft	82ft	98,4ft	131,2ft	164ft
Lux	9291lx	2323lx	1032lx	581lx	372lx	165lx	93lx	41lx	23lx	15lx	10lx	6lx	4lx
Footcand.	863fcd	216fcd	96fcd	54fcd	35fcd	15fcd	9fcd	4fcd	2fcd	1fcd	1fcd	1fcd	0fcd
Beam wid.	1,5m	2,9m	4,4m	5,9m	7,4m	11m	14,7m	22,1m	29,4m	36,8m	44,2m	58,9m	73,6m
Beam wid.	4,9ft	9,7ft	14,4ft	19,3ft	24,1ft	36,2ft	48,3ft	72,4ft	96,6ft	120,7ft	144,9ft	193,2ft	241,5ft

## LINEAR DISTRIBUTION DIAGRAM

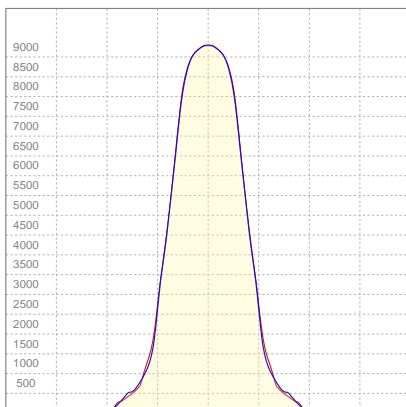

## ELECTRICAL SPECIFICATIONS

Input voltage	Input current	Input power	Effeciency
227V	1,05A	229,1W	62lm/W

## ISO CANDELA DIAGRAM

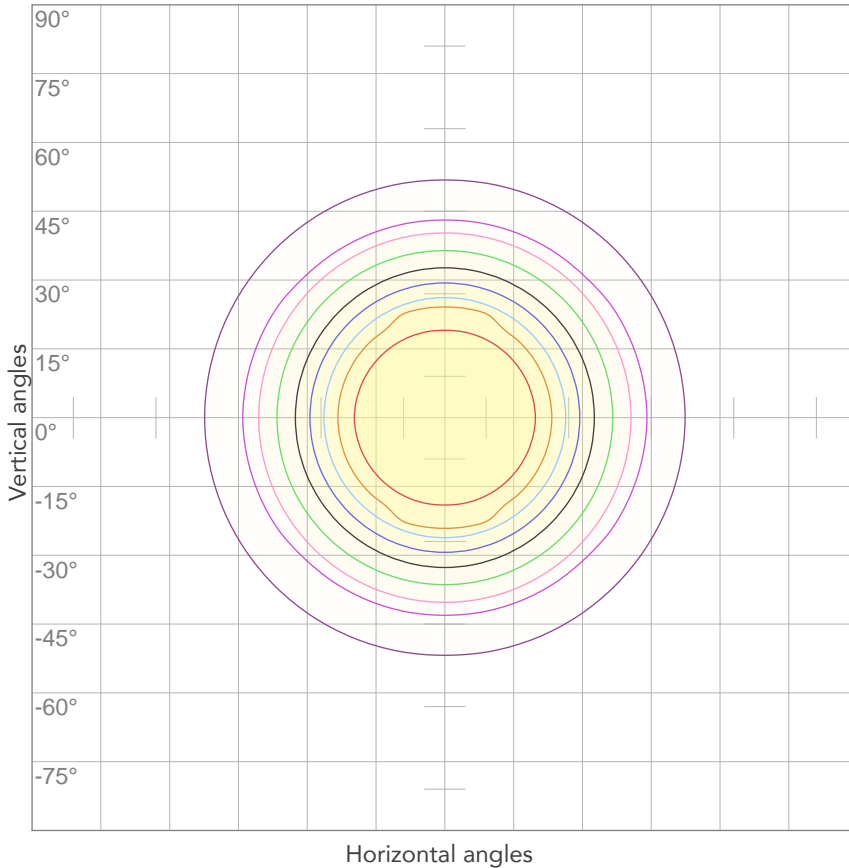

10%	929 cd
20%	1858 cd
30%	2787 cd
40%	3717 cd
50%	4646 cd
60%	5575 cd
70%	6504 cd
80%	7433 cd

**Conditions:**

Number of c-planes: 4

Candela at center: 9291 cd

## ISO LUX DIAGRAM

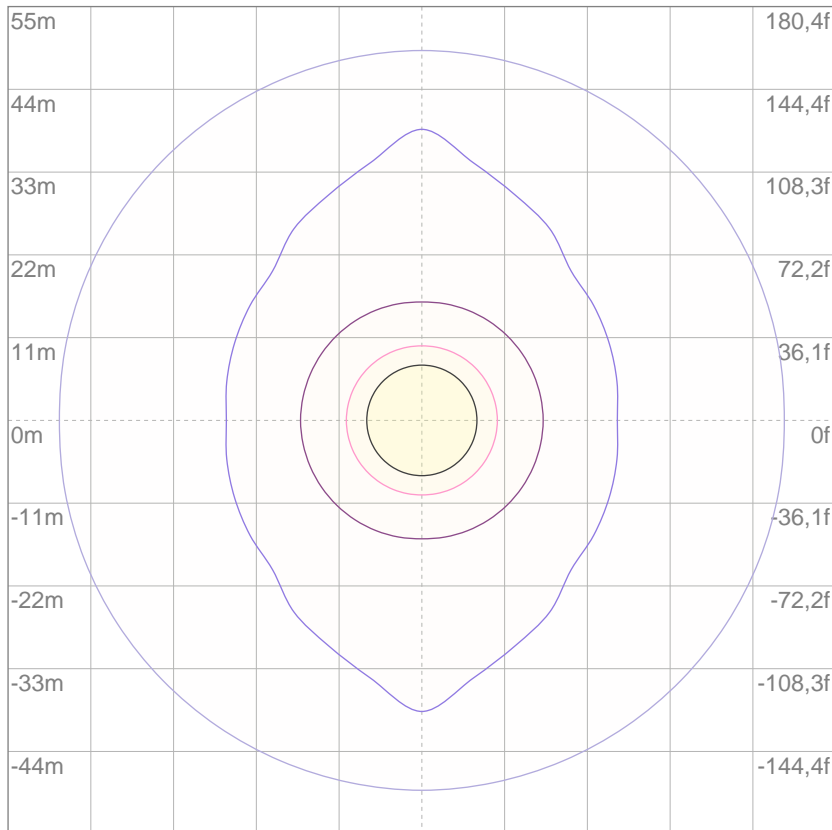

Mounting height: 10 meters (33 feet)

3%	2,79 lx
5%	4,65 lx
10%	9,29 lx
30%	27,9 lx
50%	46,5 lx

**Conditions:**

Number of c-planes: 4

Lux at center: 92,9 lx

*Lux distribution on a surface when lamp is mounted at 10 meters from the surface.*





Total lumen output:

14069 lm

Peak candela output:

4851 cd

Light quality:

CRI: 91,5

Color temperature:

6614 K

**PRODUCT NAME:**

ECLPANEL TWCJR

**MEASUREMENT CONDITIONS:**

Beam angle:

Filter HD

Target:

6000K

Operator:

Paolo Carvone

Date and time:

14/05/2020 16:27:59

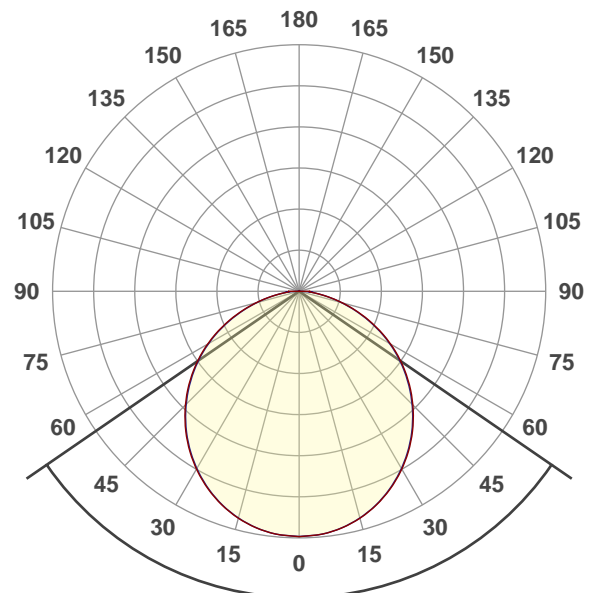

Beam angle 50%: 111°

Field angle 10%: 161,2°

Cut off angle 2.5%: 177°

Spectra

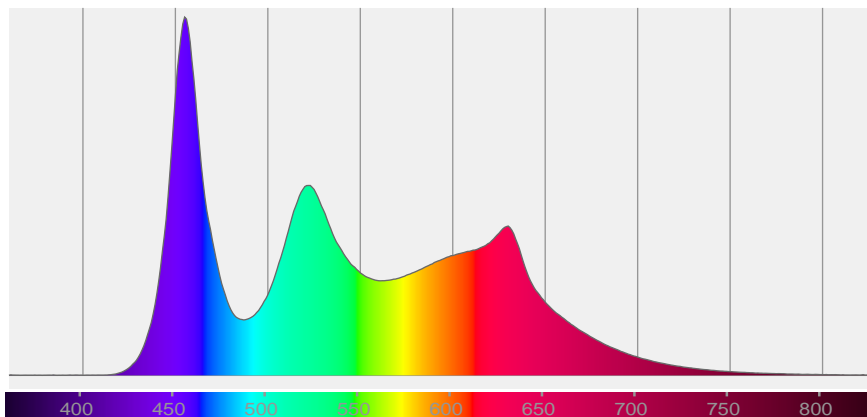

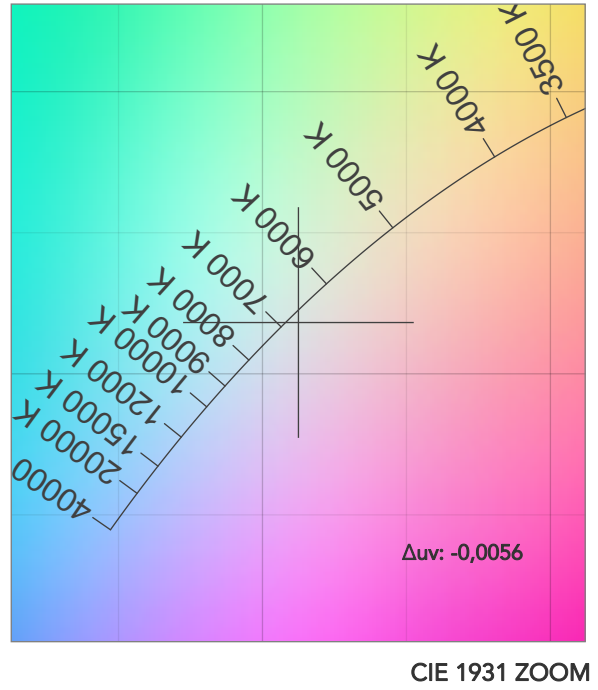
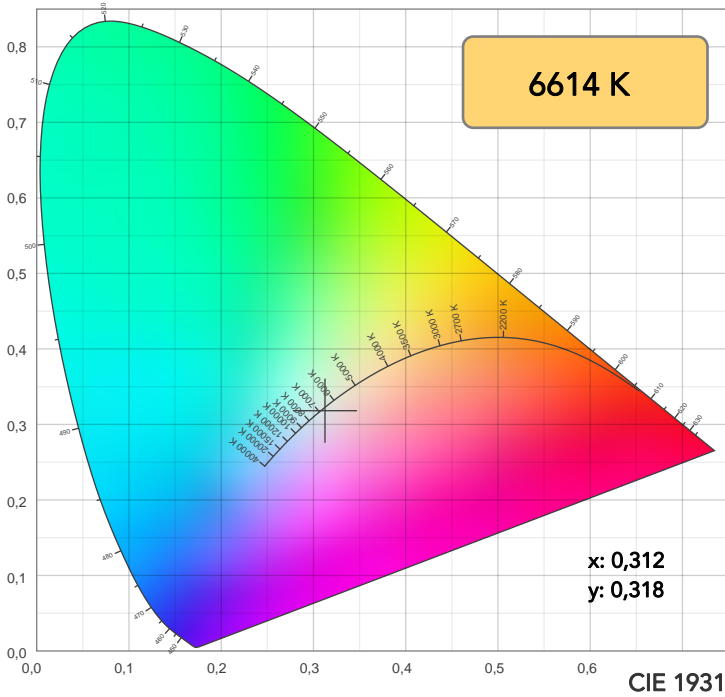

TM30: 88,1

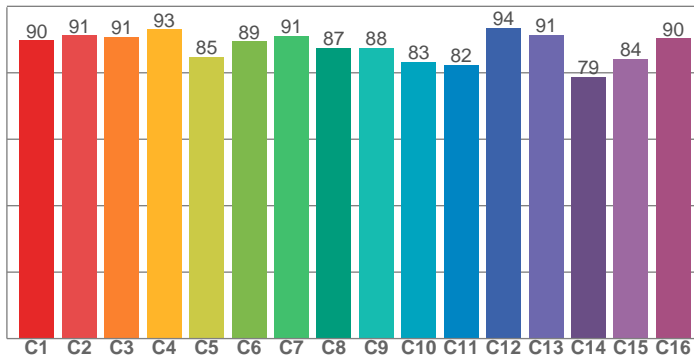

CRI: 91,5 (R1-R8)

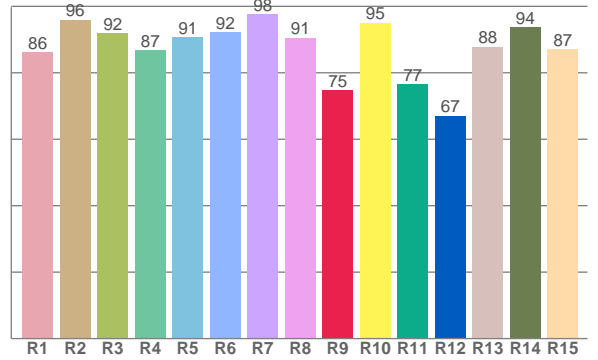

CRI R values, only R1-R8 are used to calculate final CRI value

R1	R2	R3	R4	R5	R6	R7	R8	R9	R10	R11	R12	R13	R14	R15
86,2	96,0	91,8	86,7	90,6	92,2	97,5	90,5	74,7	95,0	76,5	67,0	87,9	93,6	87,1

TM30 C values, 16 binned values out of total of 99 C values

C1	C2	C3	C4	C5	C6	C7	C8	C9	C10	C11	C12	C13	C14	C15	C16
89,7	91,2	90,9	93,1	84,8	89,5	91,1	87,4	87,6	83,3	82,3	93,6	91,4	78,7	84,2	90,4

CQS Q values

Q1	Q2	Q3	Q4	Q5	Q6	Q7	Q8	Q9	Q10	Q11	Q12	Q13	Q14	Q15
92,8	99,4	86,5	91,0	98,3	97,8	98,8	95,2	92,9	97,0	95,7	94,2	95,3	94,3	93,4

CQS: 93,9

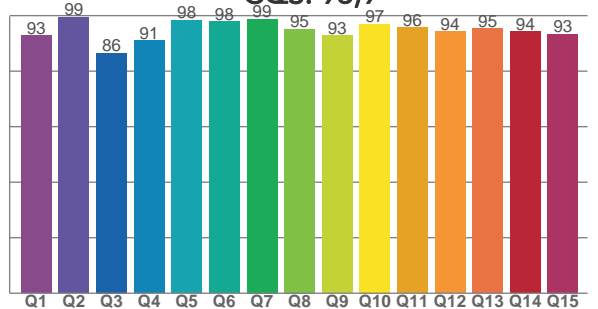

COLOR PARAMETERS

Color temperature	Color rendering index	Red component	Color fidelity	Color gamut	Color quality scale	Television lighting index	Color coordinate cie 1931	Color coordinate cie 1931	Color deviation from black body
CCT	CRI	CRI R9	TM30 Rf	TM30 Rg	CQS	TLCI	x	y	Δuv
6614 K	91,5	74,7	88,1	104,5	93,9	93	0,312	0,318	-0,0056

# TM30 DETAILS

**Rf 88,1**  
Fidelity index Rf

**Rg 104,5**  
Gammut index

Hue Bin	R <sub>f</sub>	Graphic shifts (%)	
		Chroma	Hue
1	90	3%	1%
2	91	4%	0%
3	91	2%	-3%
4	93	-2%	-2%
5	85	-7%	-1%
6	89	1%	4%
7	91	4%	3%
8	87	2%	6%
9	88	1%	9%
10	83	1%	10%
11	82	4%	8%
12	94	3%	1%
13	91	4%	1%
14	79	13%	2%
15	84	8%	-2%
16	90	3%	3%

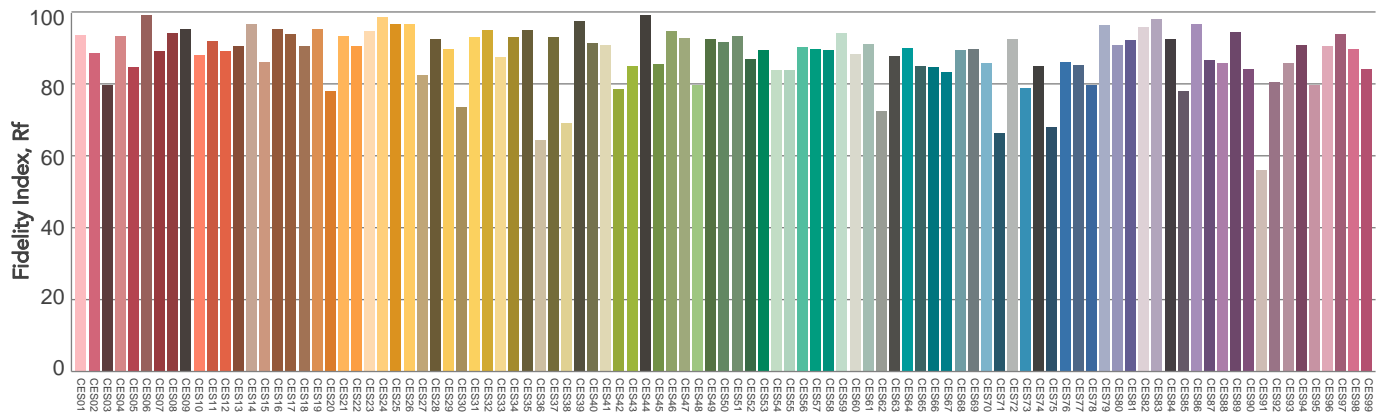
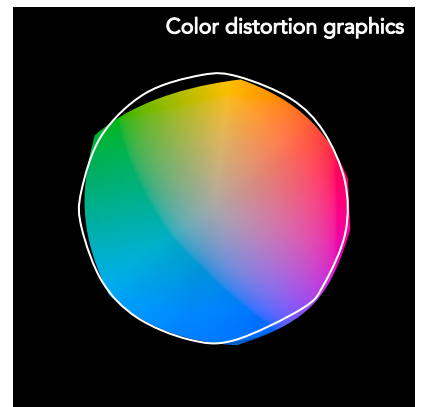
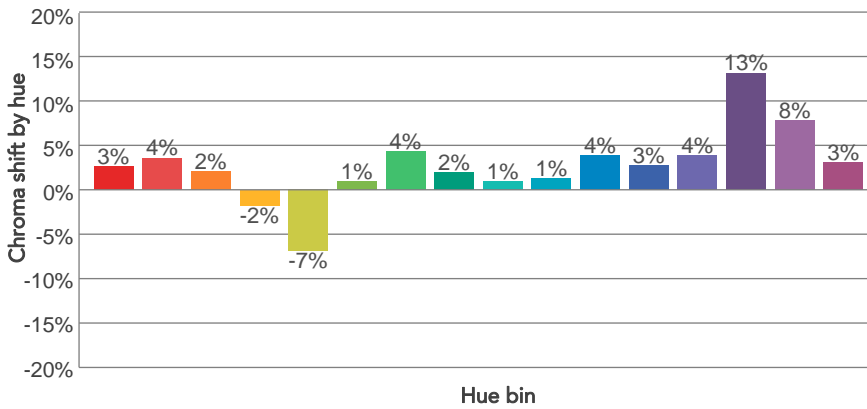
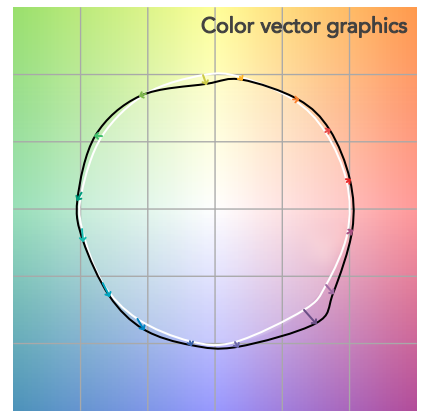
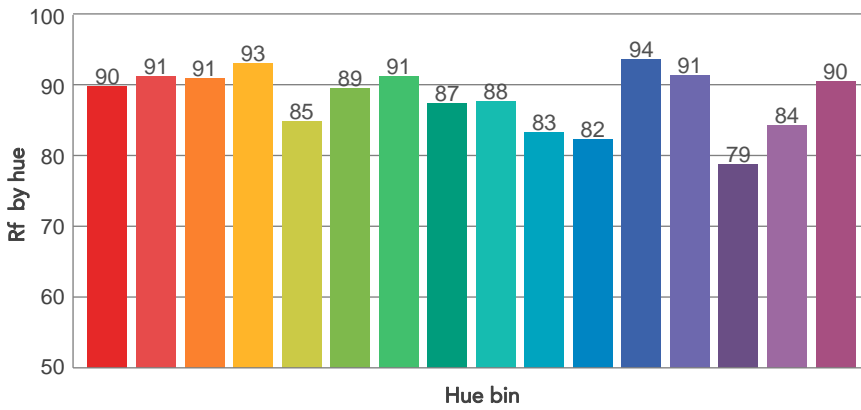
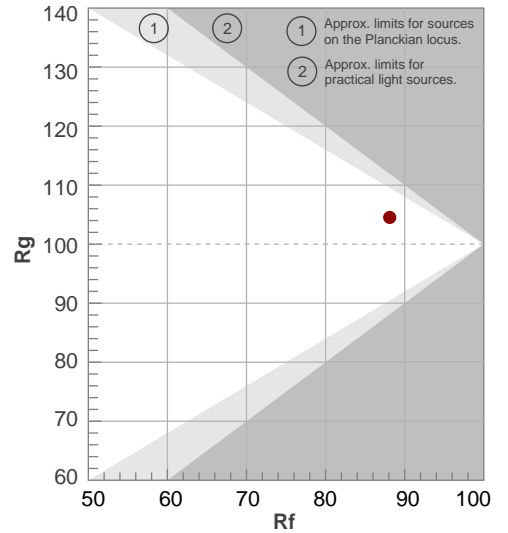

Color Evaluation Sample

# BEAM DETAILS



Beam angle 50%	Field angle 10%	Cut off angle 2,5%	Intensity ratio in 120° cone	Intensity ratio in 90° cone
111°	161,2°	177°	76,6%	52,2%

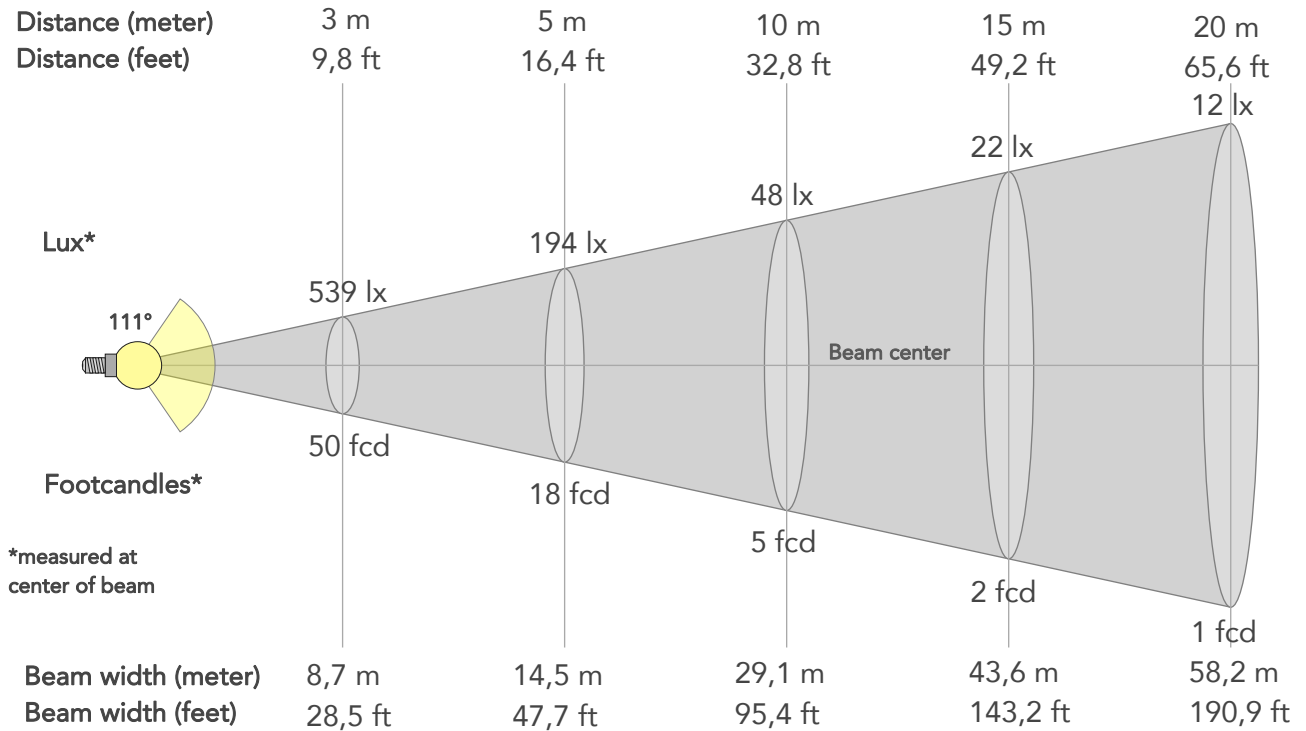

## BEAM INTENSITIES AND WIDTHS

Distance	1m	2m	3m	4m	5m	7,5m	10m	15m	20m	25m	30m	40m	50m
Distance	3,3ft	6,6ft	9,8ft	13,1ft	16,4ft	24,6ft	32,8ft	49,2ft	65,6ft	82ft	98,4ft	131,2ft	164ft
Lux	4850lx	1212lx	539lx	303lx	194lx	86lx	48lx	22lx	12lx	8lx	5lx	3lx	2lx
Footcand.	451fcd	113fcd	50fcd	28fcd	18fcd	8fcd	5fcd	2fcd	1fcd	1fcd	1fcd	0fcd	0fcd
Beam wid.	2,9m	5,8m	8,7m	11,6m	14,5m	21,8m	29,1m	43,6m	58,2m	72,7m	87,3m	116,4m	145,5m
Beam wid.	9,6ft	19,2ft	28,5ft	38,1ft	47,7ft	71,6ft	95,4ft	143,2ft	190,9ft	238,6ft	286,3ft	381,8ft	477,2ft

## LINEAR DISTRIBUTION DIAGRAM

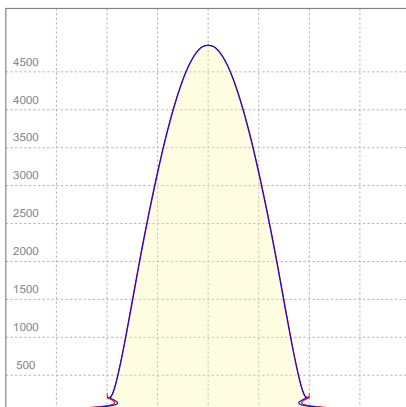

## ELECTRICAL SPECIFICATIONS

Input voltage	Input current	Input power	Effeciency
225V	1,02A	226,5W	62lm/W

## ISO CANDELA DIAGRAM

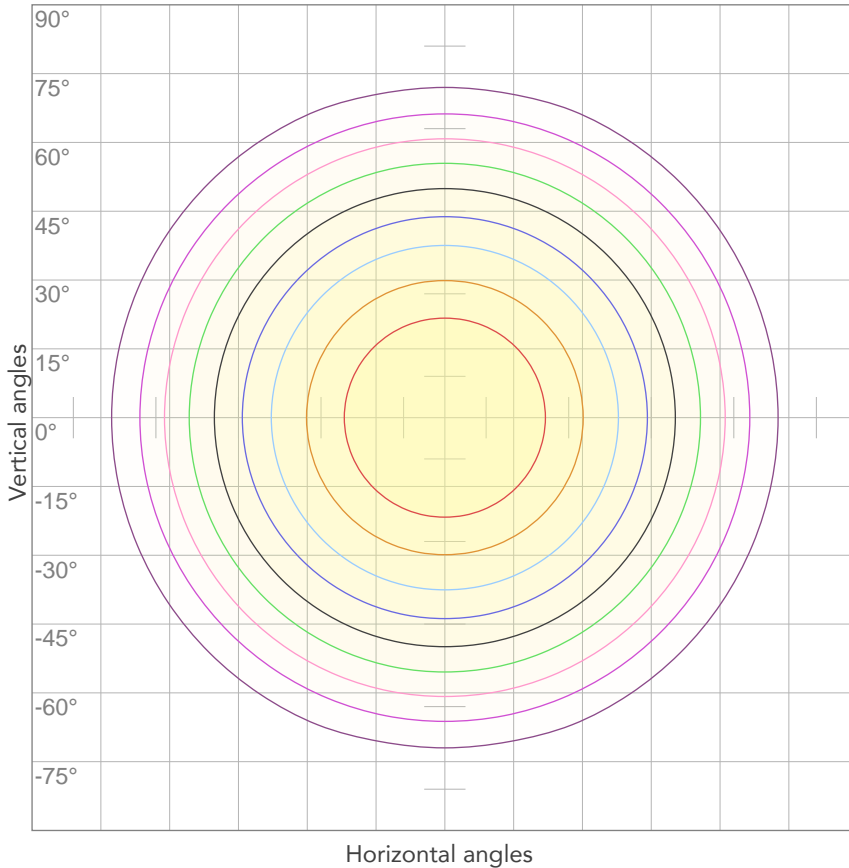

10%	485 cd
20%	970 cd
30%	1455 cd
40%	1940 cd
50%	2425 cd
60%	2910 cd
70%	3395 cd
80%	3880 cd

Conditions:

Number of c-planes: 4

Candela at center: 4850 cd

## ISO LUX DIAGRAM

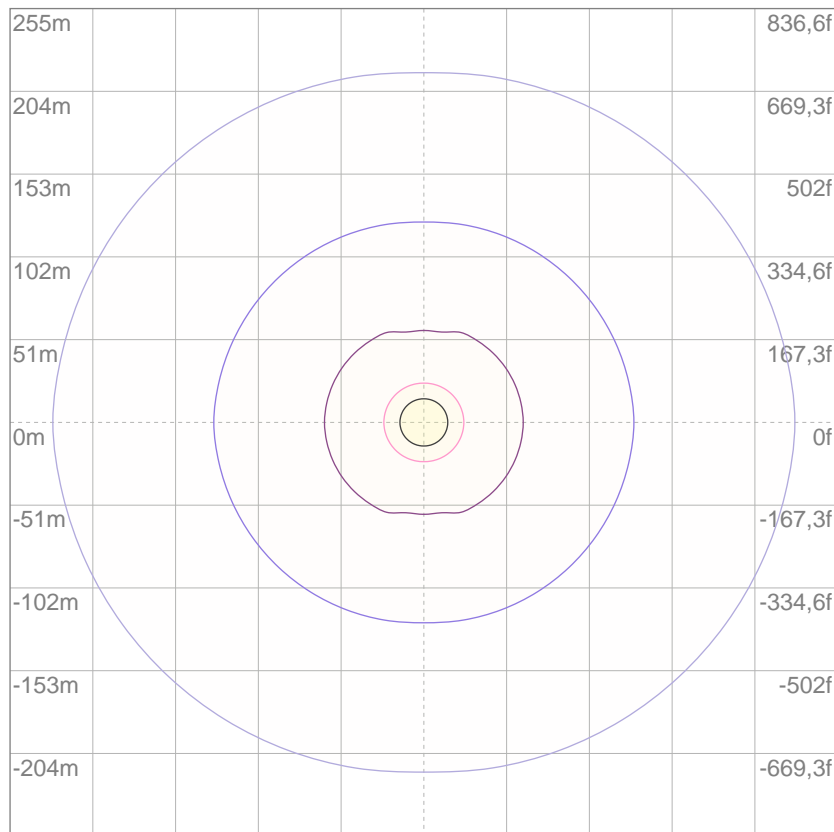

3%	1,45 lx
5%	2,42 lx
10%	4,85 lx
30%	14,5 lx
50%	24,2 lx

Conditions:

Number of c-planes: 4

Lux at center: 48,5 lx

*Lux distribution on a surface when lamp is mounted at 10 meters from the surface.*

Mounting height: 10 meters (33 feet)



Total lumen output:

16360 lm

Peak candela output:

6291 cd

Light quality:

CRI: 93,8

Color temperature:

6261 K

**PRODUCT NAME:**

**ECLPANEL TWCJR**

**MEASUREMENT CONDITIONS:**

Beam angle:

Filter MD

Target:

6000K

Operator:

Paolo Carvone

Date and time:

14/05/2020 16:11:10

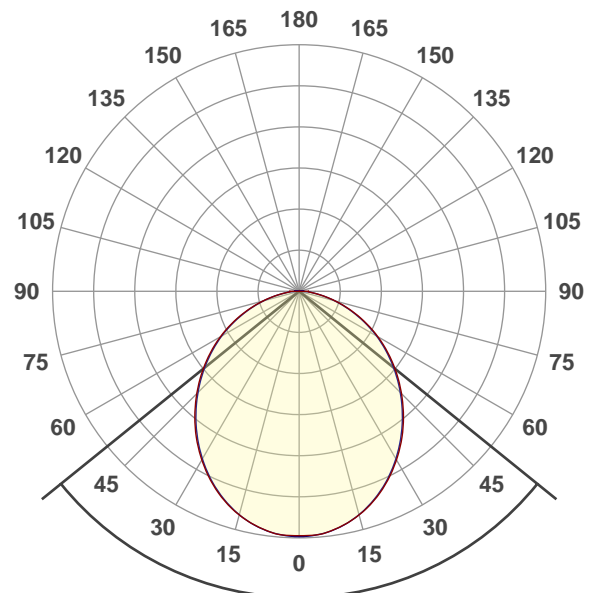

Beam angle 50%: 102,1°

Field angle 10%: 158,3°

Cut off angle 2.5%: 177,3°

Spectra

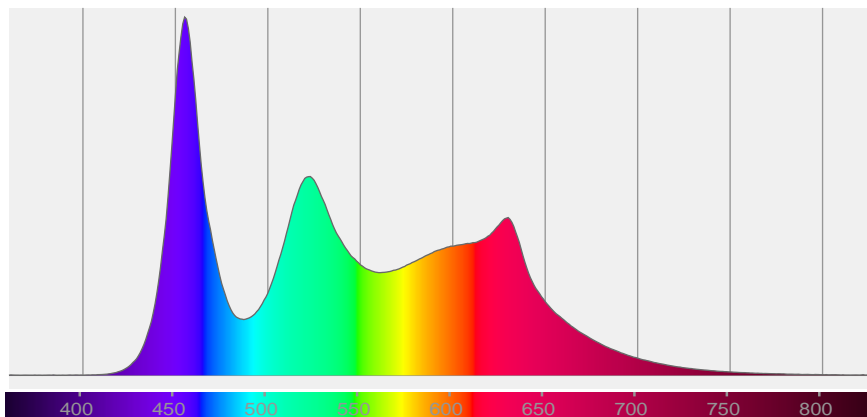

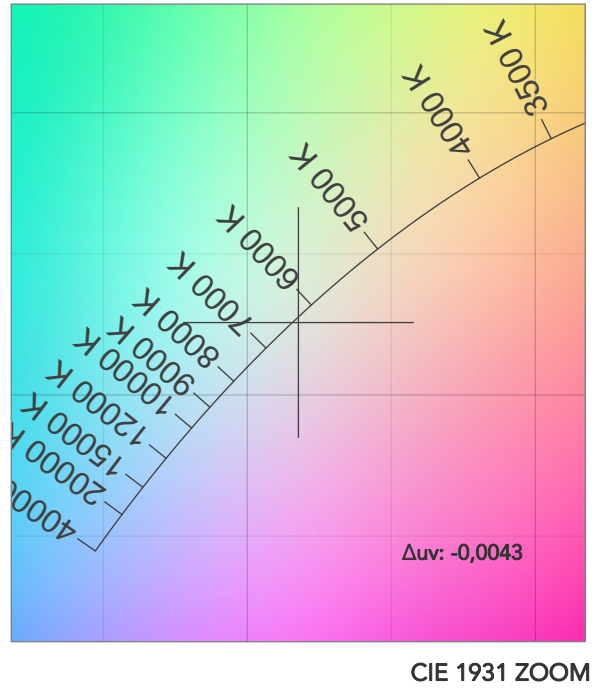
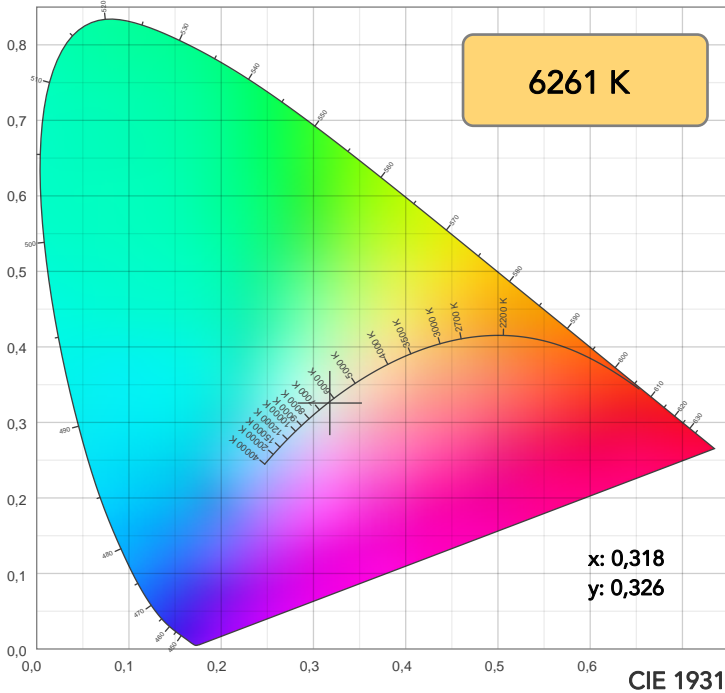

TM30: 89,0

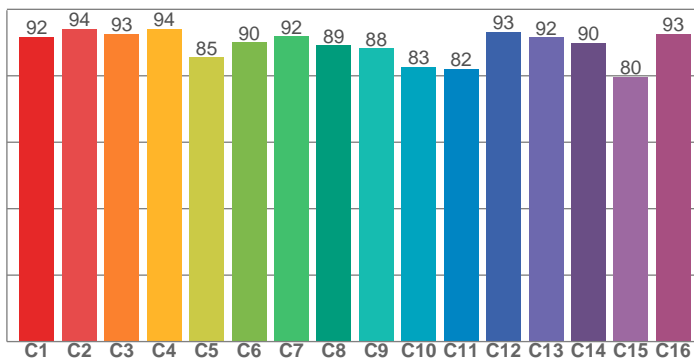

CRI: 93,8 (R1-R8)

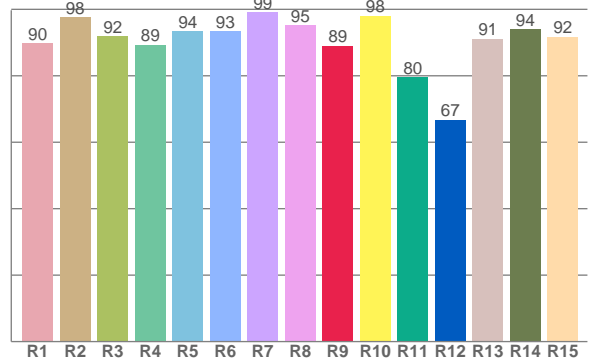

CRI R values, only R1-R8 are used to calculate final CRI value

R1	R2	R3	R4	R5	R6	R7	R8	R9	R10	R11	R12	R13	R14	R15
89,8	97,5	92,0	89,4	93,5	93,4	99,2	95,3	89,0	98,1	79,7	66,7	91,1	94,0	91,8

TM30 C values, 16 binned values out of total of 99 C values

C1	C2	C3	C4	C5	C6	C7	C8	C9	C10	C11	C12	C13	C14	C15	C16
91,7	94,1	92,6	94,2	85,5	90,0	91,9	89,2	88,3	82,6	82,1	93,2	91,6	90,0	79,7	92,6

CQS Q values

Q1	Q2	Q3	Q4	Q5	Q6	Q7	Q8	Q9	Q10	Q11	Q12	Q13	Q14	Q15
93,0	99,3	85,6	89,9	97,7	97,3	97,8	96,8	93,5	95,9	97,5	96,2	96,8	95,2	95,2

CQS: 94,1

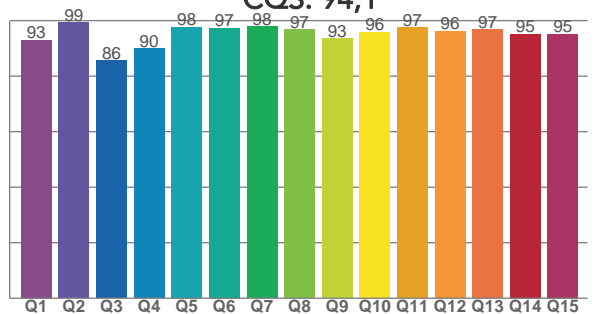

COLOR PARAMETERS

Color temperature	Color rendering index	Red component	Color fidelity	Color gamut	Color quality scale	Television lighting index	Color coordinate cie 1931	Color coordinate cie 1931	Color deviation from black body
CCT	CRI	CRI R9	TM30 Rf	TM30 Rg	CQS	TLCI	x	y	Δuv
6261 K	93,8	89,0	89,0	103,5	94,1	93	0,318	0,326	-0,0043

# TM30 DETAILS

**Rf 89,0**  
Fidelity index Rf

**Rg 103,5**  
Gammut index

Hue Bin	R <sub>f</sub>	Graphic shifts (%)	
		Chroma	Hue
1	92	1%	1%
2	94	3%	0%
3	93	1%	-1%
4	94	-2%	-1%
5	85	-6%	0%
6	90	1%	4%
7	92	4%	2%
8	89	1%	5%
9	88	0%	8%
10	83	0%	10%
11	82	4%	9%
12	93	3%	2%
13	92	4%	-1%
14	90	2%	3%
15	80	12%	-8%
16	93	2%	2%

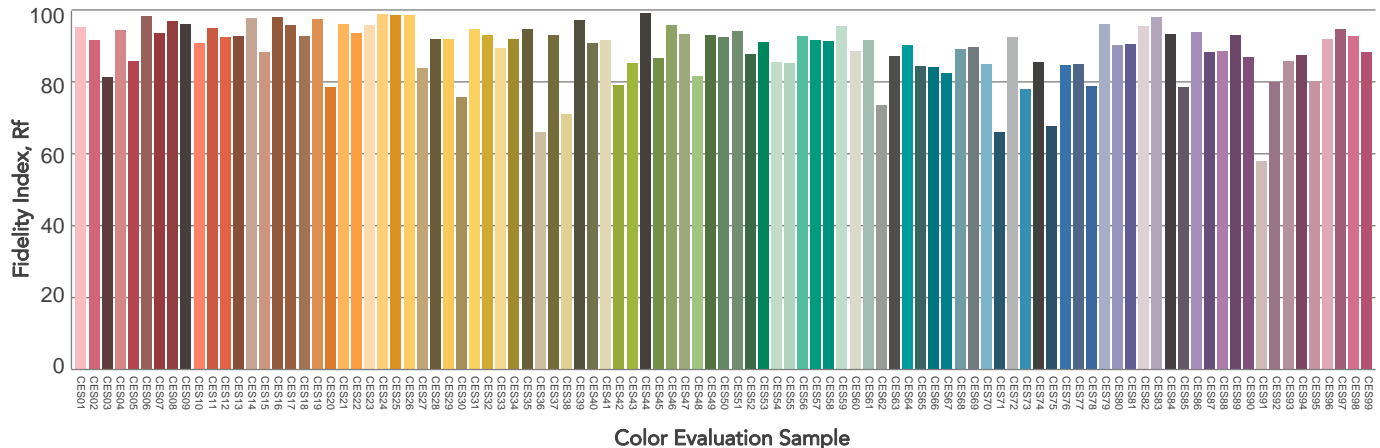
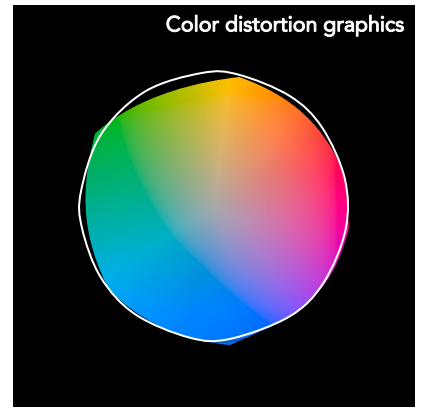
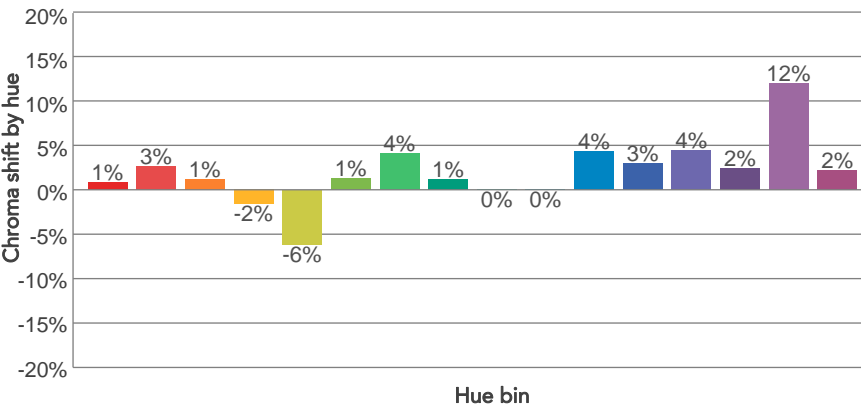
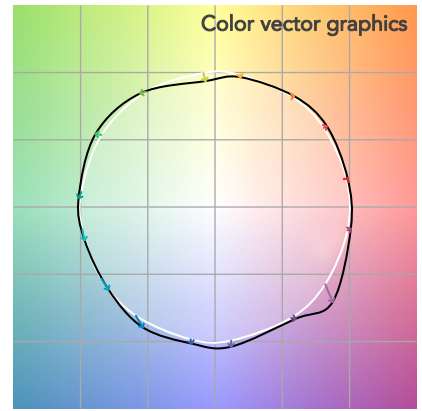
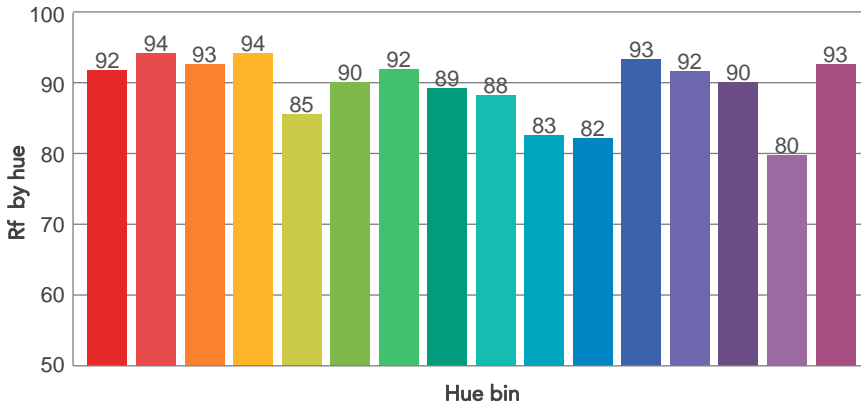
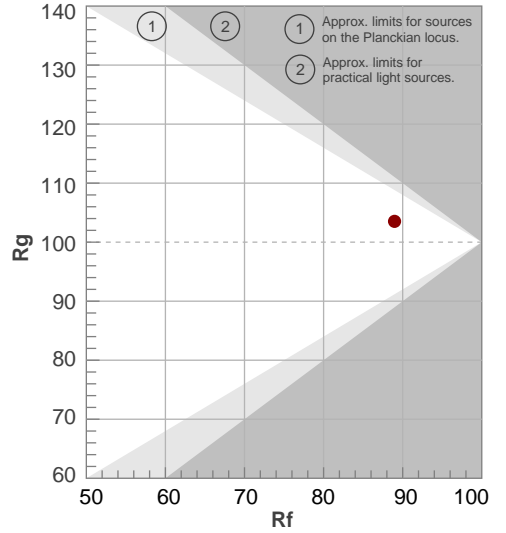



# BEAM DETAILS



Beam angle 50%	Field angle 10%	Cut off angle 2,5%	Intensity ratio in 120° cone	Intensity ratio in 90° cone
102,1°	158,3°	177,3°	79,0%	55,3%

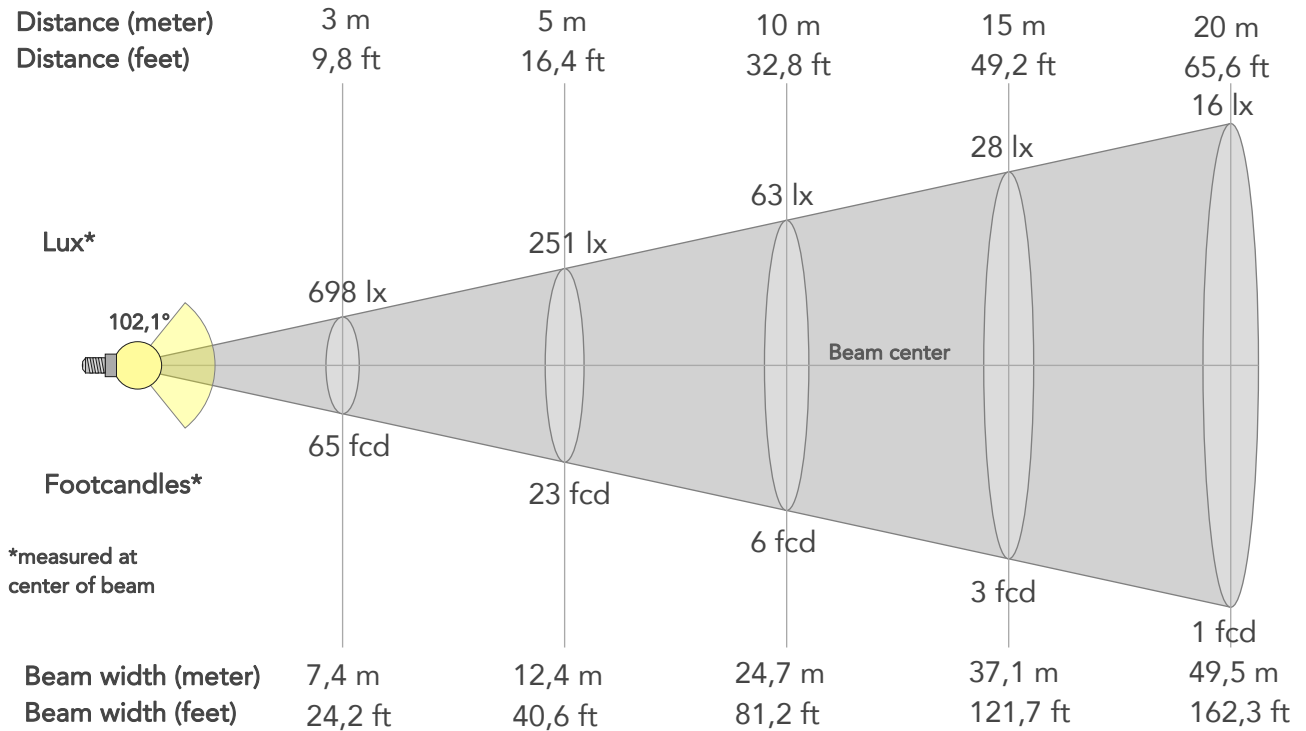

## BEAM INTENSITIES AND WIDTHS

Distance	1m	2m	3m	4m	5m	7,5m	10m	15m	20m	25m	30m	40m	50m
Distance	3,3ft	6,6ft	9,8ft	13,1ft	16,4ft	24,6ft	32,8ft	49,2ft	65,6ft	82ft	98,4ft	131,2ft	164ft
Lux	6281lx	1570lx	698lx	393lx	251lx	112lx	63lx	28lx	16lx	10lx	7lx	4lx	3lx
Footcand.	584fcd	146fcd	65fcd	36fcd	23fcd	10fcd	6fcd	3fcd	1fcd	1fcd	1fcd	0fcd	0fcd
Beam wid.	2,5m	4,9m	7,4m	9,9m	12,4m	18,6m	24,7m	37,1m	49,5m	61,9m	74,2m	99m	123,7m
Beam wid.	8,2ft	16,3ft	24,2ft	32,4ft	40,6ft	60,9ft	81,2ft	121,7ft	162,3ft	202,9ft	243,5ft	324,6ft	405,8ft

## LINEAR DISTRIBUTION DIAGRAM

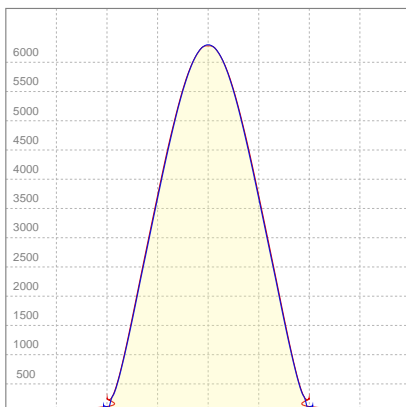

## ELECTRICAL SPECIFICATIONS

Input voltage	Input current	Input power	Effeciency
225V	1,03A	226,8W	72lm/W

## ISO CANDELA DIAGRAM

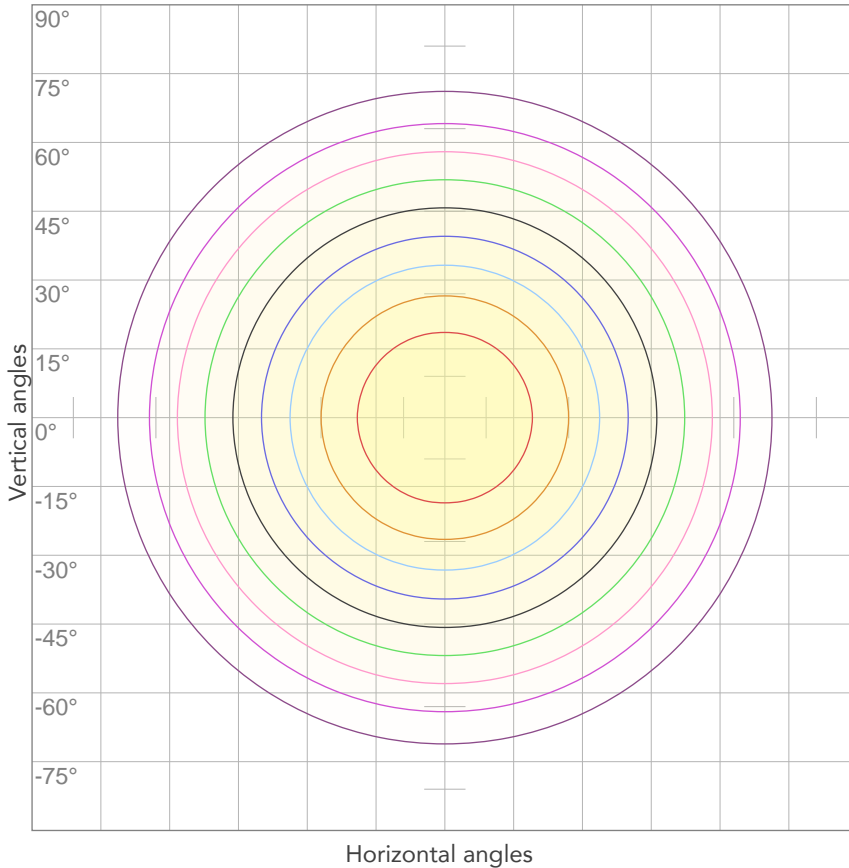

10%	628 cd
20%	1256 cd
30%	1884 cd
40%	2513 cd
50%	3141 cd
60%	3769 cd
70%	4397 cd
80%	5025 cd

Conditions:

Number of c-planes: 4

Candela at center: 6281 cd

## ISO LUX DIAGRAM

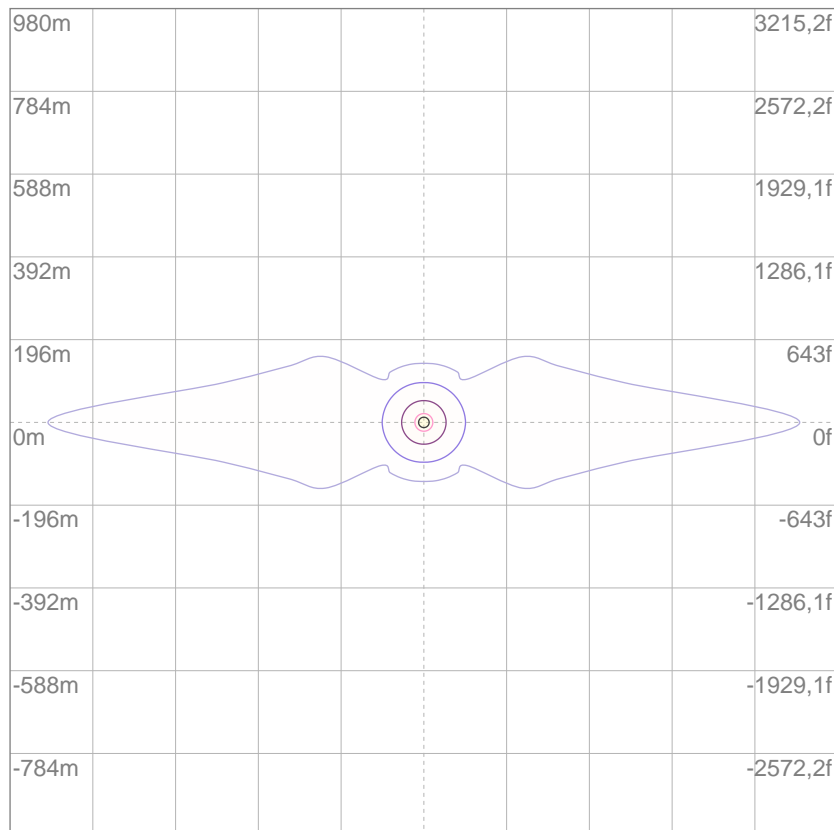

3%	1,88 lx
5%	3,14 lx
10%	6,28 lx
30%	18,8 lx
50%	31,4 lx

Conditions:

Number of c-planes: 4

Lux at center: 62,8 lx

*Lux distribution on a surface when lamp is mounted at 10 meters from the surface.*

Mounting height: 10 meters (33 feet)



Total lumen output:

16609 lm

Peak candela output:

6422 cd

Light quality:

CRI: 93,7

Color temperature:

6317 K

**PRODUCT NAME:**

ECLPANEL TWCJR

**MEASUREMENT CONDITIONS:**

Beam angle:

Filter LD

Target:

6000K

Operator:

Paolo Carvone

Date and time:

14/05/2020 15:54:42

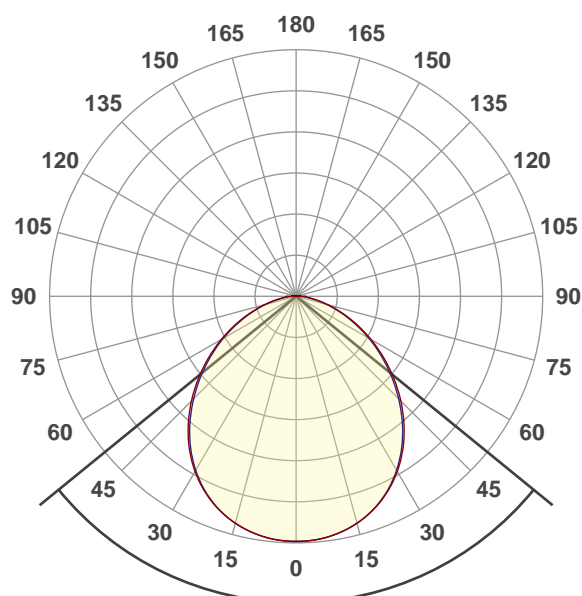

Beam angle 50%: 101,7°

Field angle 10%: 156°

Cut off angle 2.5%: 177°

Spectra

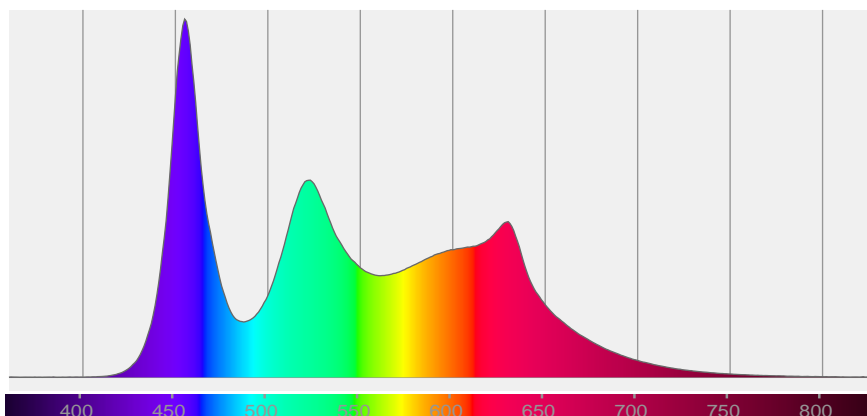

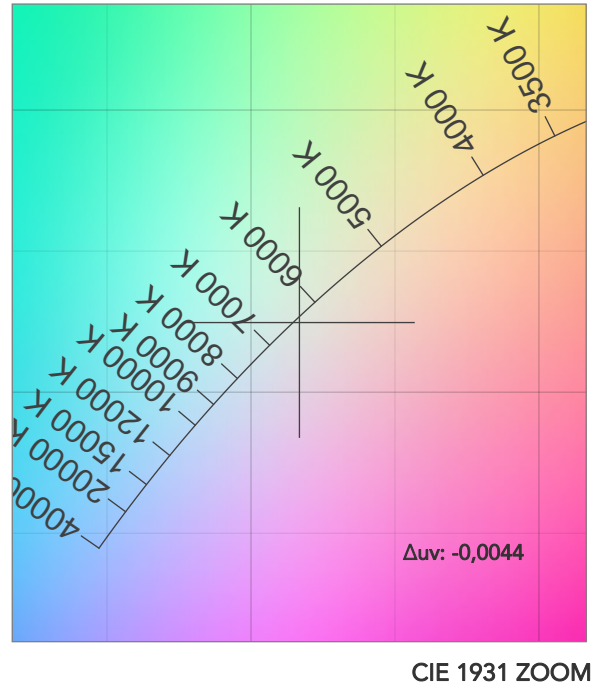
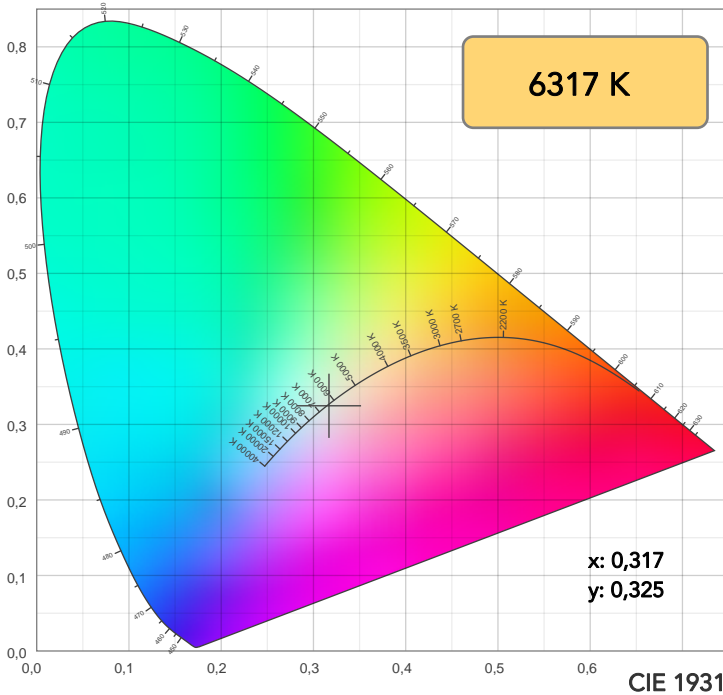

TM30: 88,9

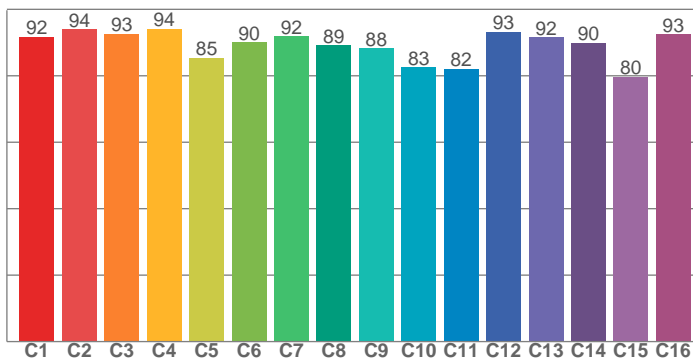

CRI: 93,7 (R1-R8)

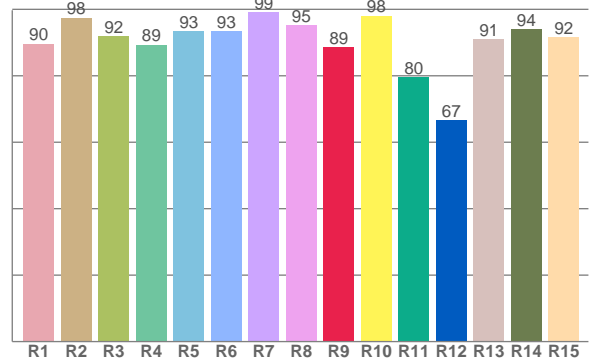

CRI R values, only R1-R8 are used to calculate final CRI value

R1	R2	R3	R4	R5	R6	R7	R8	R9	R10	R11	R12	R13	R14	R15
89,7	97,5	91,9	89,3	93,5	93,4	99,2	95,2	88,7	98,1	79,6	66,6	91,1	93,9	91,6

TM30 C values, 16 binned values out of total of 99 C values

C1	C2	C3	C4	C5	C6	C7	C8	C9	C10	C11	C12	C13	C14	C15	C16
91,7	94,0	92,5	94,2	85,4	90,0	91,9	89,2	88,2	82,5	82,0	93,2	91,6	89,9	79,7	92,5

CQS Q values

Q1	Q2	Q3	Q4	Q5	Q6	Q7	Q8	Q9	Q10	Q11	Q12	Q13	Q14	Q15
93,0	99,3	85,5	89,8	97,7	97,3	97,9	96,8	93,4	95,8	97,5	96,2	96,8	95,2	95,2

CQS: 94,1

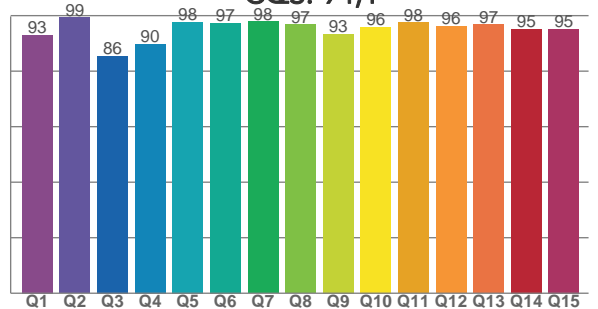

COLOR PARAMETERS

Color temperature	Color rendering index	Red component	Color fidelity	Color gamut	Color quality scale	Television lighting index	Color coordinate cie 1931	Color coordinate cie 1931	Color deviation from black body
CCT	CRI	CRI R9	TM30 Rf	TM30 Rg	CQS	TLCI	x	y	Δuv
6317 K	93,7	88,7	88,9	103,6	94,1	93	0,317	0,325	-0,0044

# TM30 DETAILS

**Rf 88,9**  
Fidelity index Rf

**Rg 103,6**  
Gammut index

Hue Bin	R <sub>f</sub>	Graphic shifts (%)	
		Chroma	Hue
1	92	1%	1%
2	94	3%	0%
3	93	1%	-1%
4	94	-2%	-1%
5	85	-6%	0%
6	90	1%	4%
7	92	4%	2%
8	89	1%	5%
9	88	0%	8%
10	83	0%	10%
11	82	4%	9%
12	93	3%	2%
13	92	4%	-1%
14	90	2%	3%
15	80	12%	-8%
16	93	2%	2%

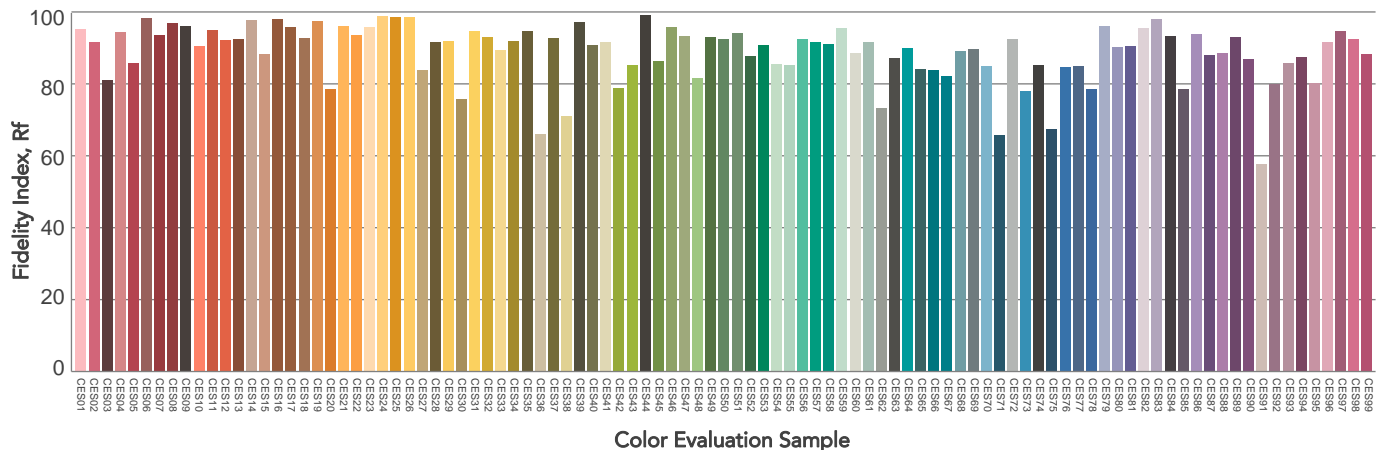
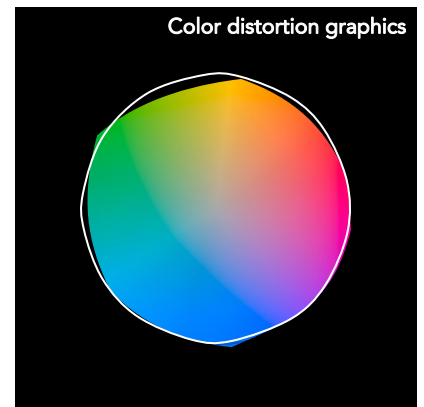
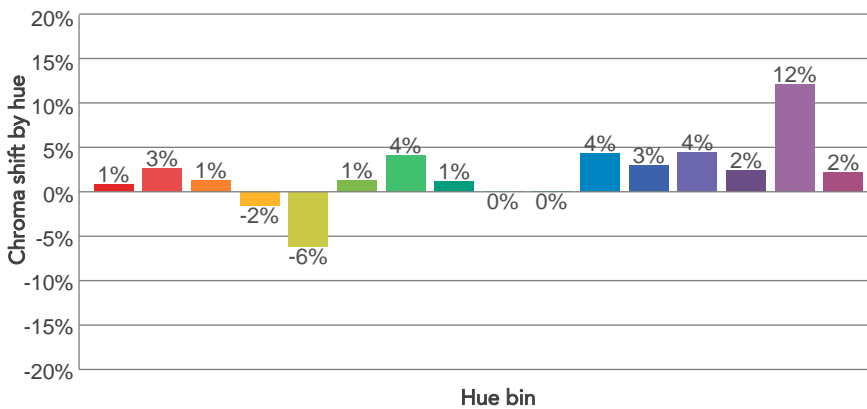
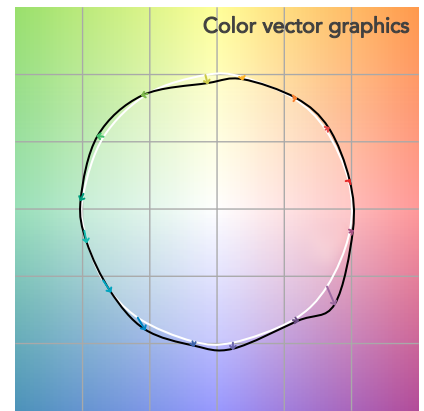
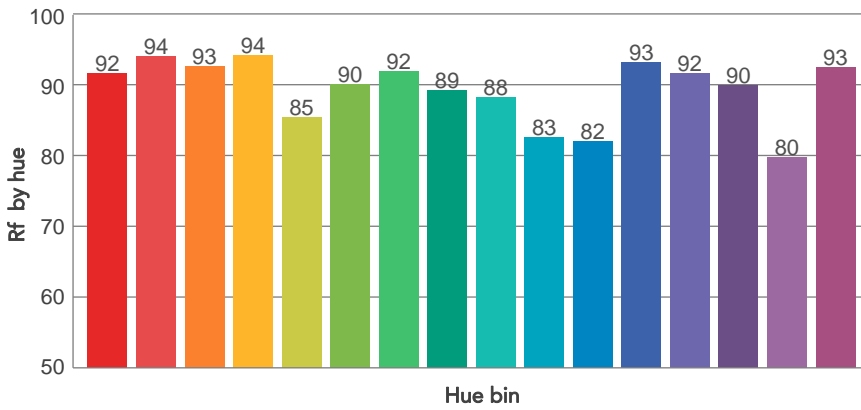
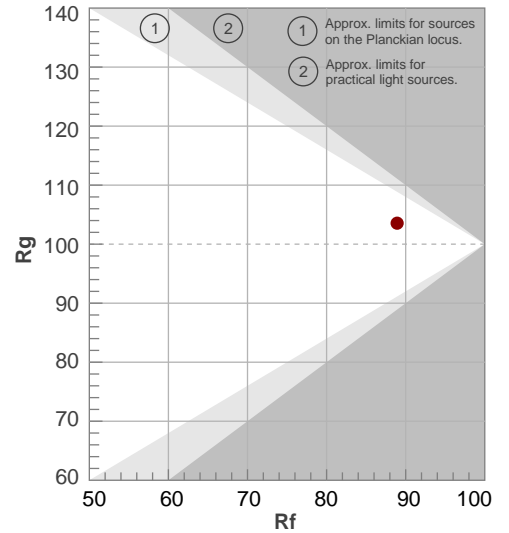

# BEAM DETAILS



Beam angle 50%	Field angle 10%	Cut off angle 2,5%	Intensity ratio in 120° cone	Intensity ratio in 90° cone
101,7°	156°	177°	80,6%	57,1%

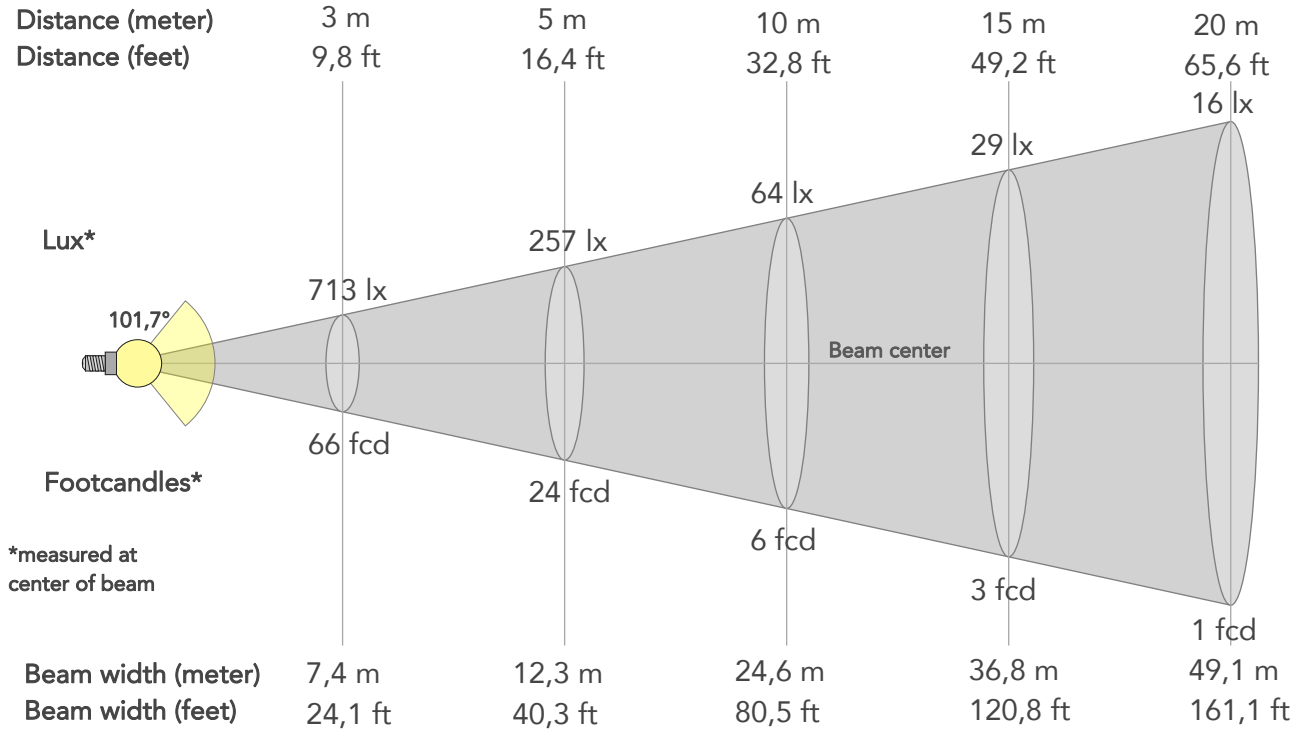

## BEAM INTENSITIES AND WIDTHS

Distance	1m	2m	3m	4m	5m	7,5m	10m	15m	20m	25m	30m	40m	50m
Distance	3,3ft	6,6ft	9,8ft	13,1ft	16,4ft	24,6ft	32,8ft	49,2ft	65,6ft	82ft	98,4ft	131,2ft	164ft
Lux	6418lx	1604lx	713lx	401lx	257lx	114lx	64lx	29lx	16lx	10lx	7lx	4lx	3lx
Footcand.	596fcd	149fcd	66fcd	37fcd	24fcd	11fcd	6fcd	3fcd	1fcd	1fcd	1fcd	0fcd	0fcd
Beam wid.	2,5m	4,9m	7,4m	9,8m	12,3m	18,4m	24,6m	36,8m	49,1m	61,4m	73,7m	98,2m	122,8m
Beam wid.	8,1ft	16,2ft	24,1ft	32,2ft	40,3ft	60,4ft	80,5ft	120,8ft	161,1ft	201,4ft	241,6ft	322,2ft	402,7ft

## LINEAR DISTRIBUTION DIAGRAM

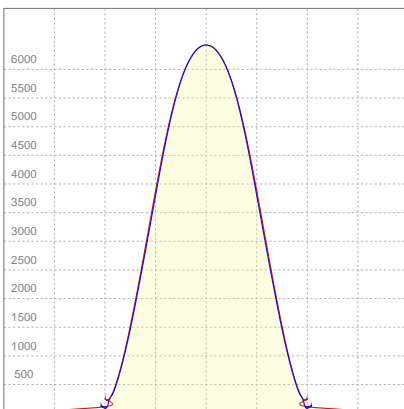

## ELECTRICAL SPECIFICATIONS

Input voltage	Input current	Input power	Effeciency
225V	1,03A	226,4W	73lm/W

## ISO CANDELA DIAGRAM

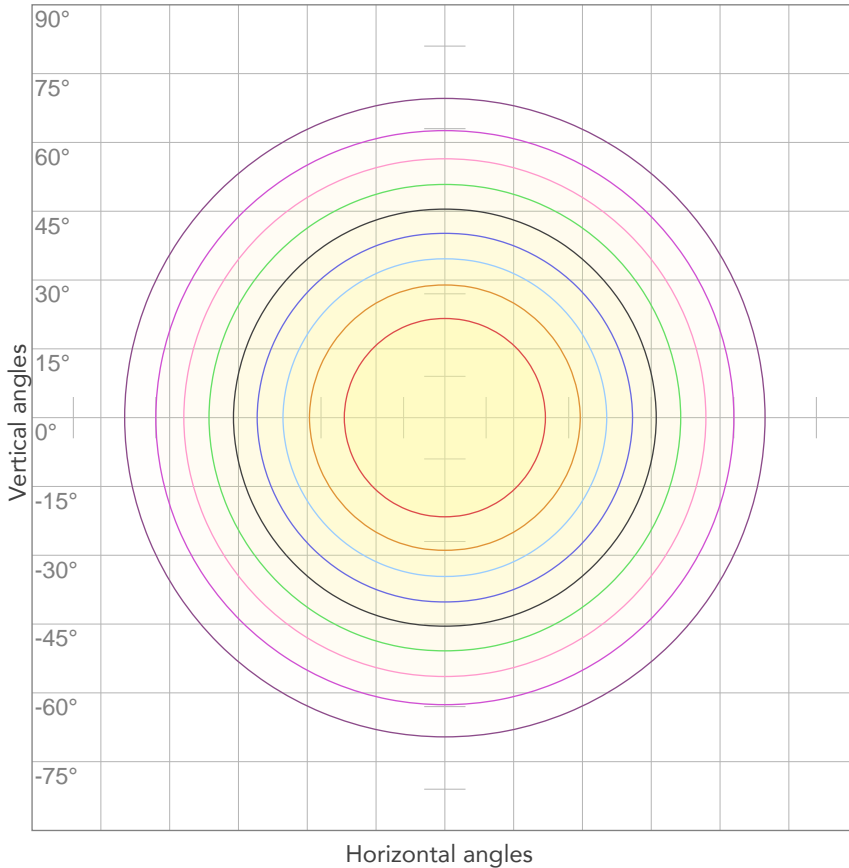

10%	642 cd
20%	1284 cd
30%	1925 cd
40%	2567 cd
50%	3209 cd
60%	3851 cd
70%	4492 cd
80%	5134 cd

Conditions:

Number of c-planes: 4

Candela at center: 6418 cd

## ISO LUX DIAGRAM

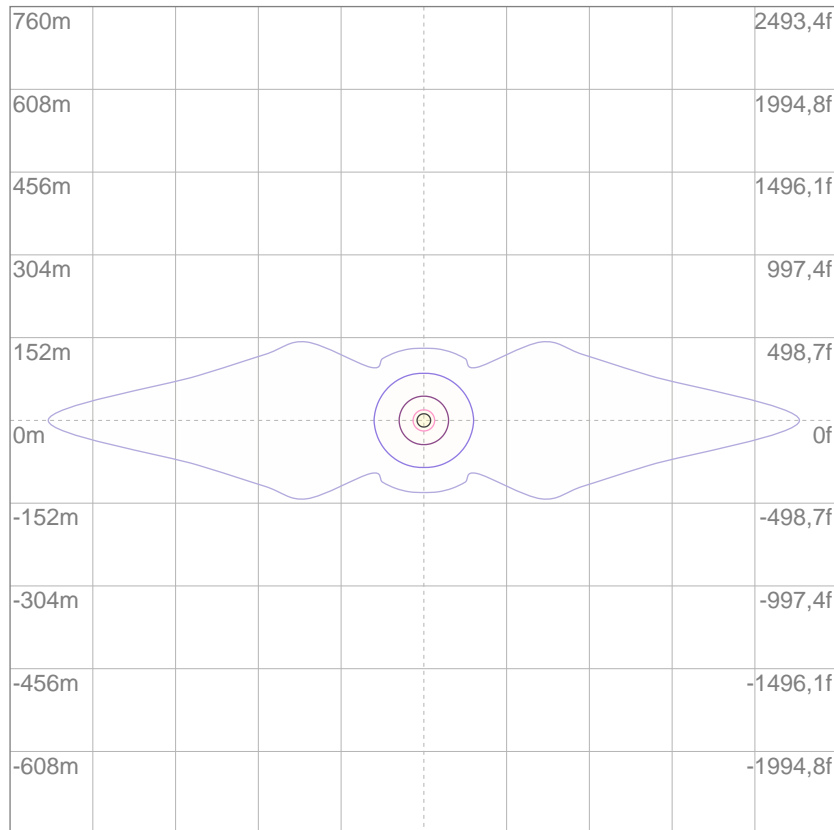

3%	1,93 lx
5%	3,21 lx
10%	6,42 lx
30%	19,3 lx
50%	32,1 lx

Conditions:

Number of c-planes: 4

Lux at center: 64,2 lx

*Lux distribution on a surface when lamp is mounted at 10 meters from the surface.*

Mounting height: 10 meters (33 feet)



Total lumen output:

14101 lm

Peak candela output:

9213 cd

Light quality:

CRI: 95,3

Color temperature:

6099 K

**PRODUCT NAME:**

ECLPANEL TWCJR

**MEASUREMENT CONDITIONS:**

Beam angle:

Filter INT

Target:

6000K

Operator:

Paolo Carvone

Date and time:

13/11/2020 12:21:59

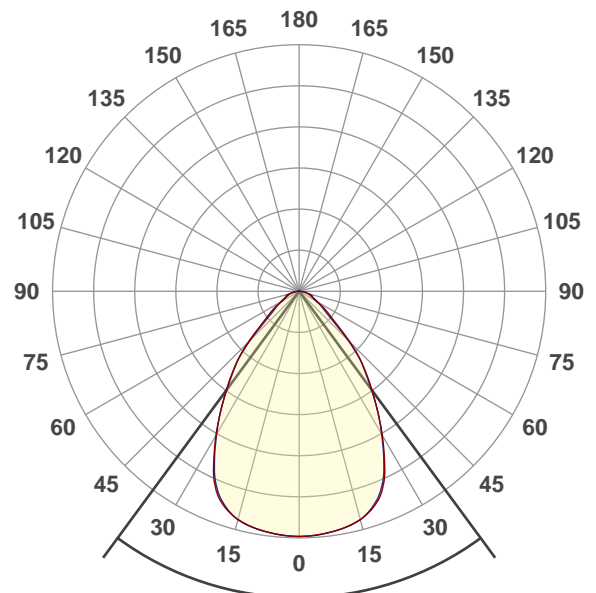

Spectra

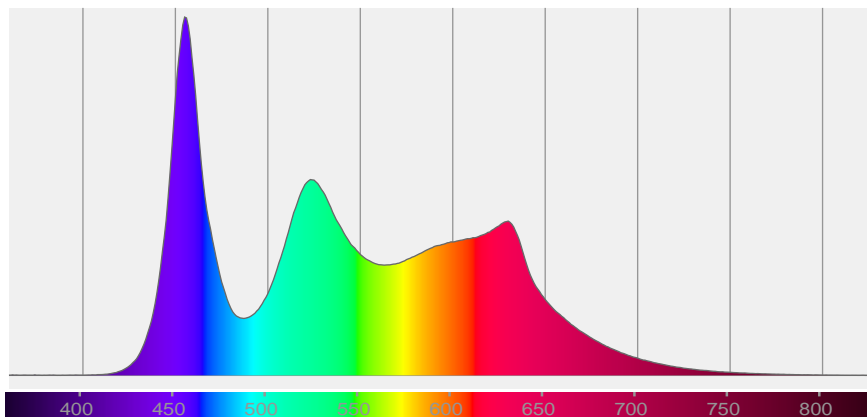



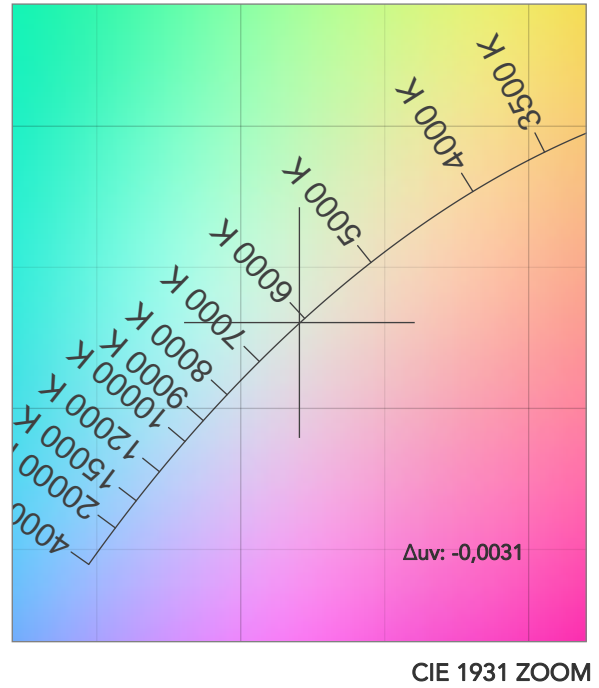
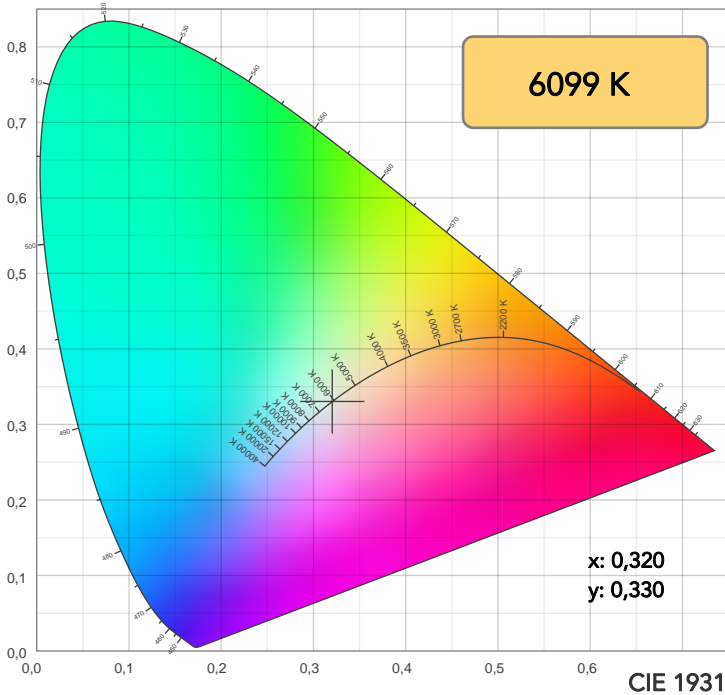

TM30: 88,9

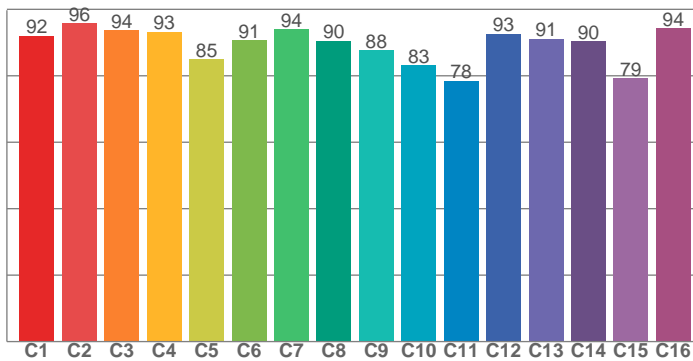

CRI: 95,3 (R1-R8)

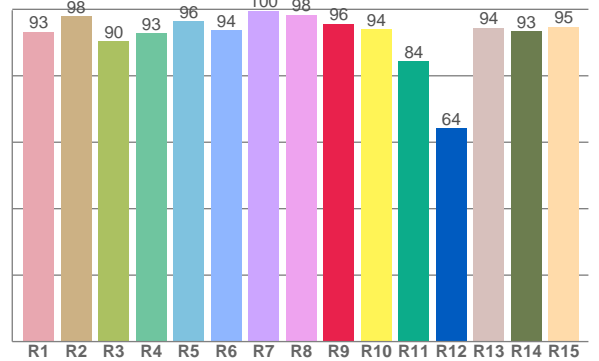

CQS: 93,3

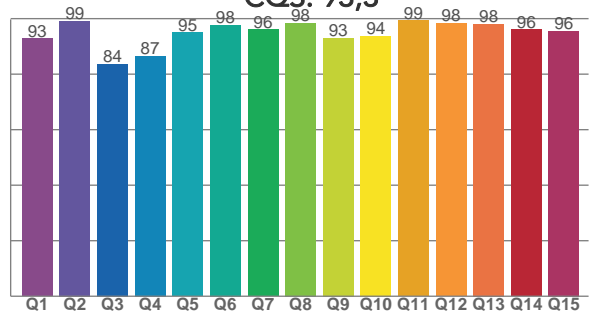

CRI R values, only R1-R8 are used to calculate final CRI value

R1	R2	R3	R4	R5	R6	R7	R8	R9	R10	R11	R12	R13	R14	R15
93,3	98,0	90,4	92,7	96,3	93,8	99,6	98,4	95,7	94,1	84,5	64,2	94,5	93,3	94,8

TM30 C values, 16 binned values out of total of 99 C values

C1	C2	C3	C4	C5	C6	C7	C8	C9	C10	C11	C12	C13	C14	C15	C16
91,9	95,8	93,7	93,3	85,0	90,7	93,9	90,4	87,7	83,2	78,5	92,7	91,1	90,4	79,2	94,2

CQS Q values

Q1	Q2	Q3	Q4	Q5	Q6	Q7	Q8	Q9	Q10	Q11	Q12	Q13	Q14	Q15
92,8	99,1	83,6	86,5	95,0	97,6	96,1	98,5	93,0	93,8	99,4	98,3	98,0	96,0	95,6

COLOR PARAMETERS

Color temperature	Color rendering index	Red component	Color fidelity	Color gamut	Color quality scale	Television lighting index	Color coordinate cie 1931	Color coordinate cie 1931	Color deviation from black body
CCT	CRI	CRI R9	TM30 Rf	TM30 Rg	CQS	TLCI	x	y	Δuv
6099 K	95,3	95,7	88,9	102,6	93,3	93	0,320	0,330	-0,0031

# TM30 DETAILS

**Rf 88,9**  
Fidelity index Rf

**Rg 102,6**  
Gammut index

Hue Bin	R <sub>f</sub>	Graphic shifts (%)	
		Chroma	Hue
1	92	-1%	1%
2	96	1%	0%
3	94	0%	0%
4	93	-1%	1%
5	85	-6%	0%
6	91	1%	3%
7	94	3%	1%
8	90	0%	4%
9	88	-2%	9%
10	83	-1%	9%
11	78	4%	11%
12	93	3%	2%
13	91	5%	-1%
14	90	3%	2%
15	79	11%	-10%
16	94	1%	1%

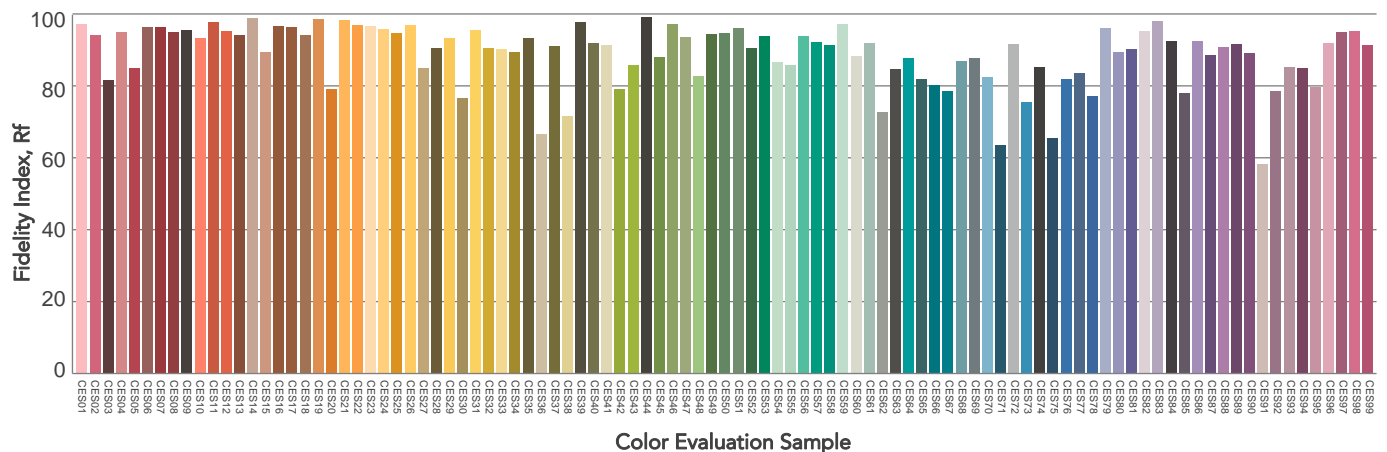
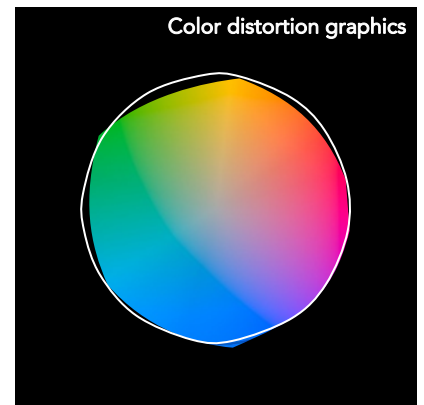
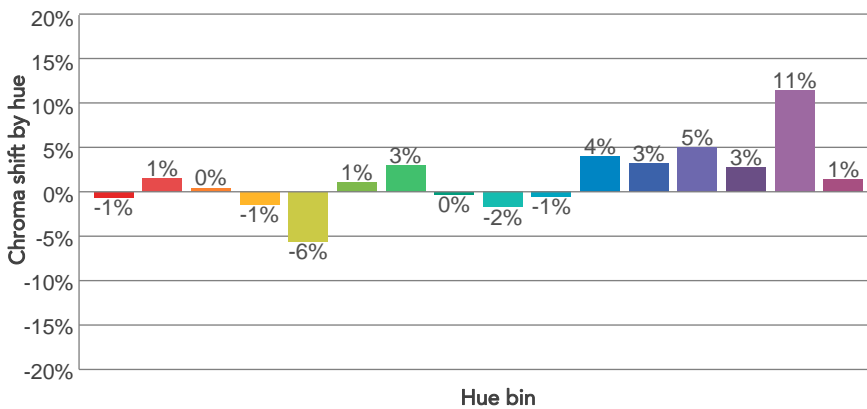
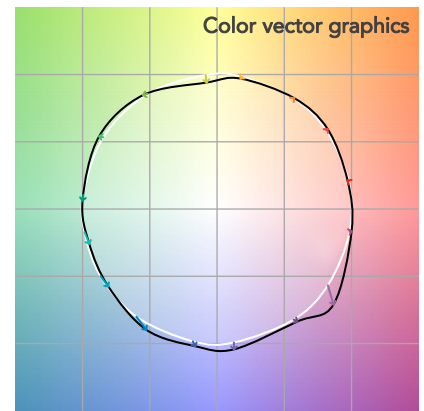
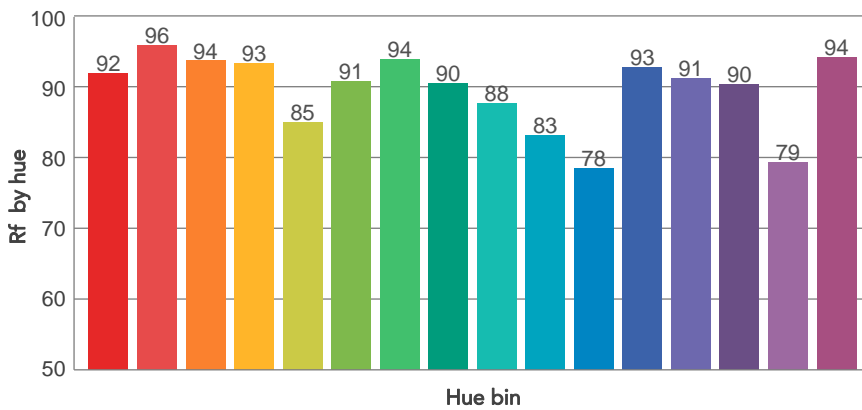
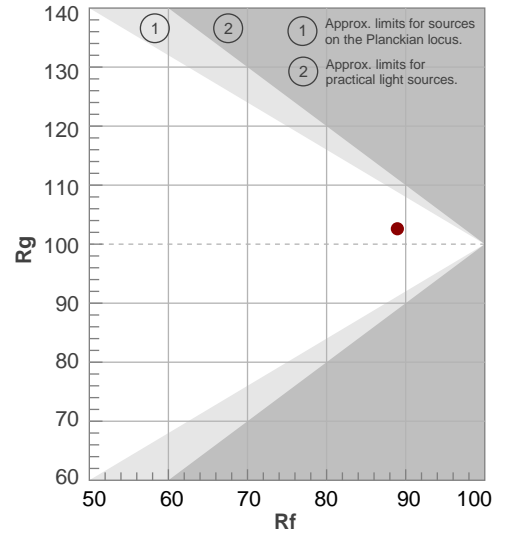

# BEAM DETAILS



Beam angle 50%	Field angle 10%	Cut off angle 2,5%	Intensity ratio in 120° cone	Intensity ratio in 90° cone
72,7°	115,7°	161,2°	91,8%	78,6%

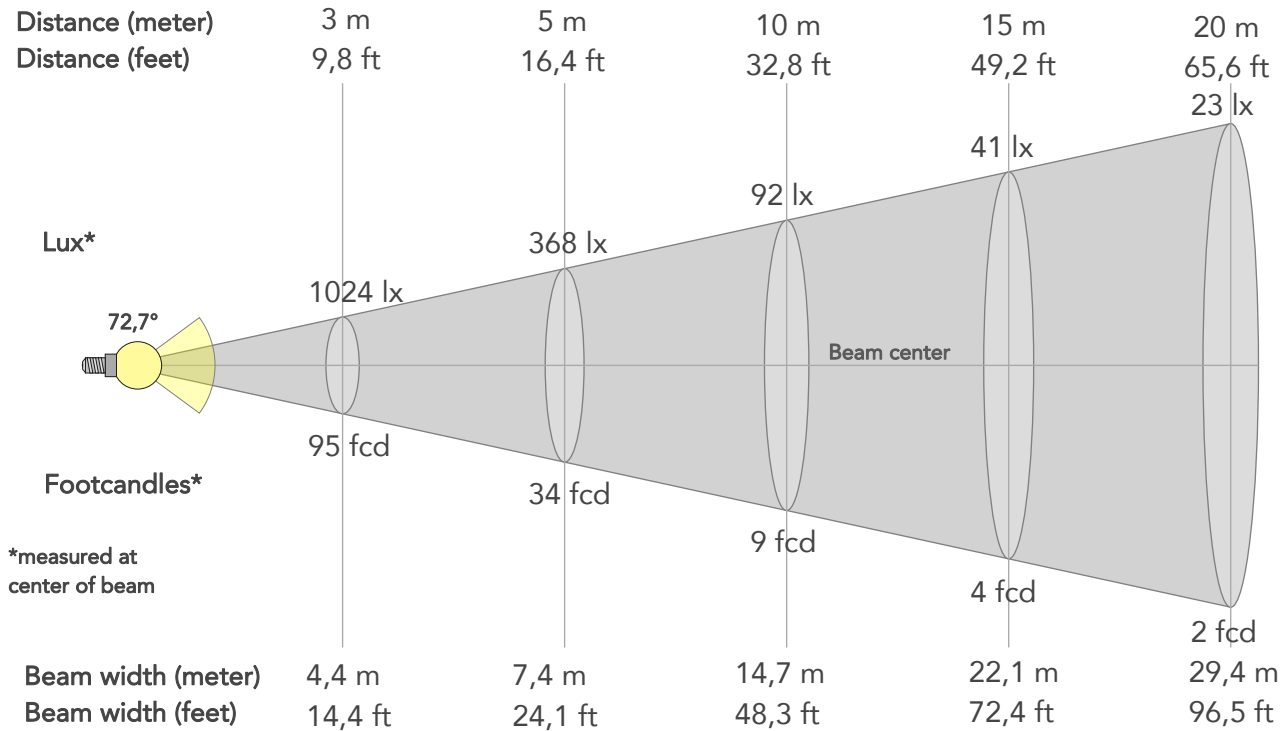

## BEAM INTENSITIES AND WIDTHS

Distance	1m	2m	3m	4m	5m	7,5m	10m	15m	20m	25m	30m	40m	50m
Distance	3,3ft	6,6ft	9,8ft	13,1ft	16,4ft	24,6ft	32,8ft	49,2ft	65,6ft	82ft	98,4ft	131,2ft	164ft
Lux	9212lx	2303lx	1024lx	576lx	368lx	164lx	92lx	41lx	23lx	15lx	10lx	6lx	4lx
Footcand.	856fcd	214fcd	95fcd	53fcd	34fcd	15fcd	9fcd	4fcd	2fcd	1fcd	1fcd	1fcd	0fcd
Beam wid.	1,5m	2,9m	4,4m	5,9m	7,4m	11m	14,7m	22,1m	29,4m	36,8m	44,1m	58,9m	73,6m
Beam wid.	4,9ft	9,7ft	14,4ft	19,3ft	24,1ft	36,2ft	48,3ft	72,4ft	96,5ft	120,6ft	144,8ft	193ft	241,3ft

## LINEAR DISTRIBUTION DIAGRAM

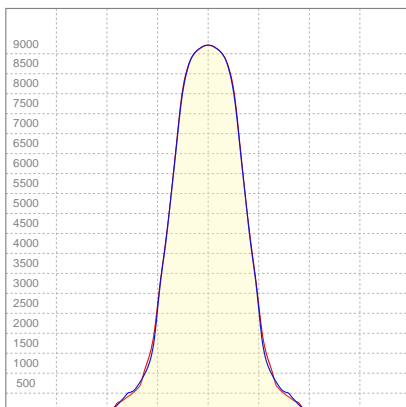

## ELECTRICAL SPECIFICATIONS

Input voltage	Input current	Input power	Effeciency
227V	1,05A	229W	62lm/W

## ISO CANDELA DIAGRAM

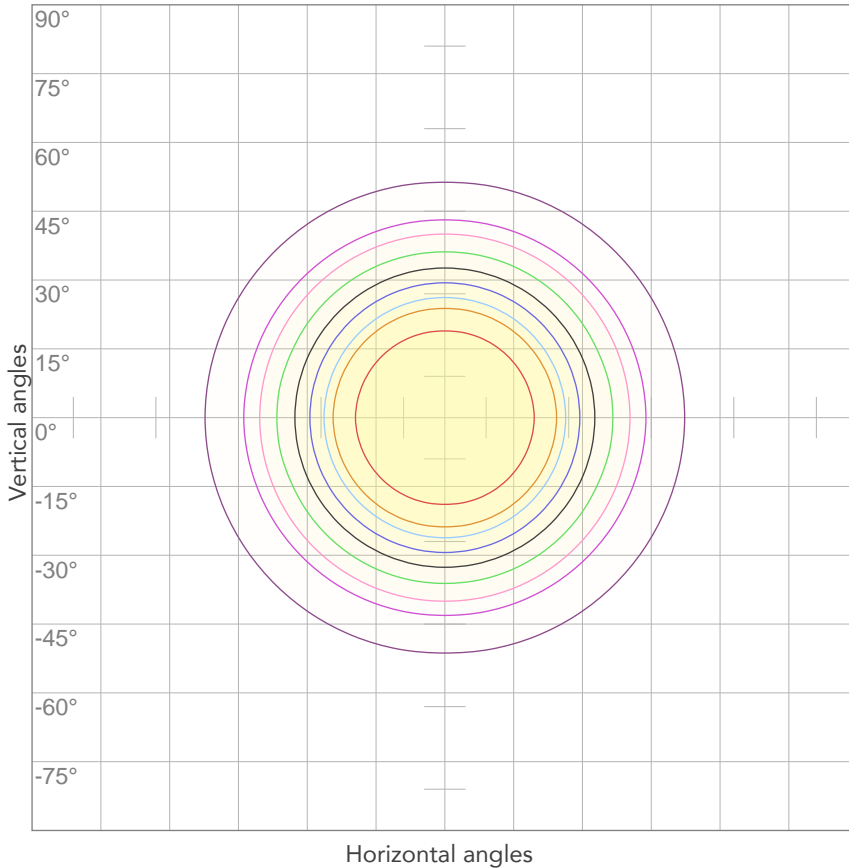

10%	921 cd
20%	1842 cd
30%	2764 cd
40%	3685 cd
50%	4606 cd
60%	5527 cd
70%	6448 cd
80%	7369 cd

Conditions:

Number of c-planes: 4

Candela at center: 9212 cd

## ISO LUX DIAGRAM

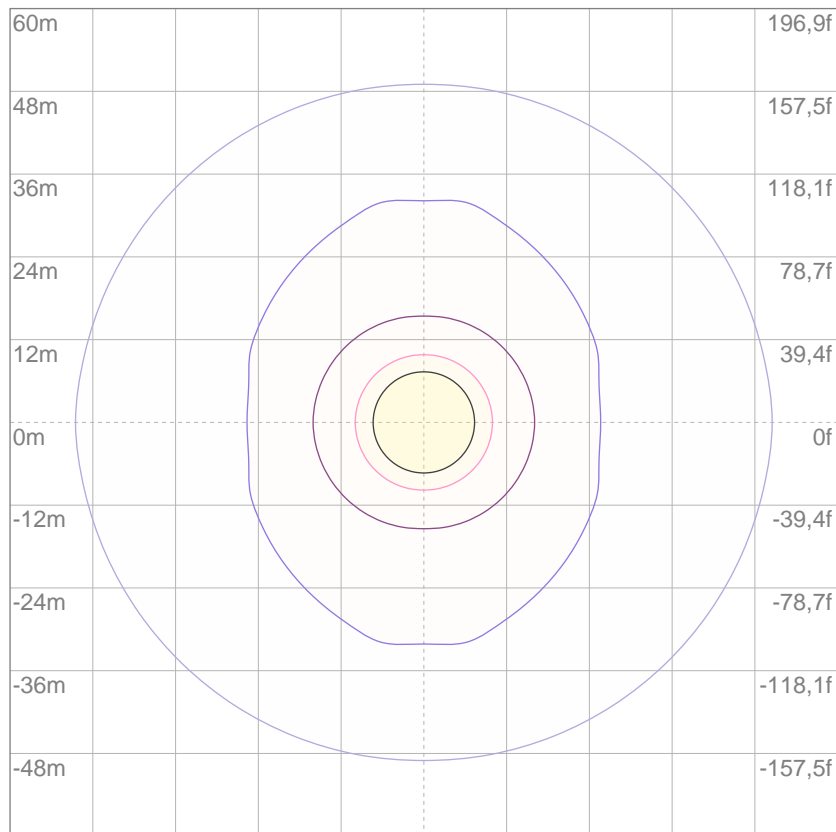

3%	2,76 lx
5%	4,61 lx
10%	9,21 lx
30%	27,6 lx
50%	46,1 lx

Conditions:

Number of c-planes: 4

Lux at center: 92,1 lx

*Lux distribution on a surface when lamp is mounted at 10 meters from the surface.*

Mounting height: 10 meters (33 feet)